



COMMON SUBJECTS
SD / SW

INDEX

<u>Ser No</u>	<u>Lesson Code</u>	<u>Subject</u>	<u>Page No</u>
1.	N	The NCC	02
2.	NI	National Integration	14
3.	FD/AD/CD	Drill	49
4.	WT	Weapon Training	97
5.	DM	Disaster Management	122
6.	SA	Social Awareness & Community Development	157
7.	H	Health & Hygiene	213
8.	EA	Environment Awareness and Conservation	261
9.	ADV	Adventure	284
10.	OT	Obstacle Training	302
11.	P	Personality Development and Leadership	309

INDEX**THE NCC**

<u>Ser No</u>	<u>Lesson Code</u>	<u>Subject</u>	<u>Cat</u>	<u>Page No</u>
1.	N 1	Aims and Objectives of NCC	SD/SW	03
2.	N 2	Organisation, Training and NCC Song	SD/SW	05
3.	N 3	Incentives	SD/SW	09

LESSON PLAN : N 1
AIMS AND OBJECTIVES OF NCC

Period	-	One
Type	-	Lecture
Code	-	N 1
Term	-	I (SD / SW)

Training Aids

1. Computer Slides, Charts, Pointer, Black board & Chalk.

Time Plan

2. (a) Introduction - 05 Min
- (b) Aims of NCC - 15 Min
- (c) Objectives of NCC - 15 Min
- (d) Conclusion - 05 Min

INTRODUCTION

3. During First World War, Britisher's created the **University Corps** with an aim for second line of defence and also to have a large pool of trained youth available for employment into the Armed Forces. NCC in India was conceptualised and raised before independence, mainly with an aim to groom the youth, boys and girls both, nurture them and channelise their energy towards nation building by making them responsible citizen.

4. After independence, the present day NCC came into existence on 16 Apr 1948, through XXXI Act of Parliament. NCC was formally inaugurated on 15 Jul 1948. The Girls Division of the NCC was raised in Jul 1949. On 01 Apr 1950, Air Wing was raised, with one Air squadron each at Bombay and Kolkata. The Naval Wing of the NCC was raised in Jul 1952, thus completing the true representation of all services in the Corps.

5. Today the NCC has an enrolled strength of more than 13 Lakhs cadets and it basically comprises of two divisions of all the three Services ie, the Senior Division / Senior Wing for boys / girls from colleges and the Junior Division / Junior Wing for boys / girls from schools. The Motto of NCC is 'Unity and Discipline'.

AIM

6. To acquaint the cadets about the Aims and Objectives of the NCC.

PREVIEW

7. The lecture will be conducted in following parts :-
 - (a) Part I - Aims of the NCC.
 - (b) Part II - Objectives of the NCC.

PART I : AIMS OF THE NCC

8. The aims of NCC are mainly three fold:-
- (a) To develop following qualities in the cadets :-
 - (aa) Development of Character.
 - (ab) Comradeship.
 - (ac) Discipline.
 - (ad) Secular Outlook.
 - (ae) Spirit of Adventure.
 - (af) Sportsmanship.
 - (ag) Ideals of selfless service among the youth of the country.
 - (b) To create a human resource of **Organised, Trained** and **Motivated** youth, to provide leadership in all walks of life and always be available for the service of the nation.
 - (c) To provide a suitable environment to motivate the youth to take up a career in the Armed Forces.

PART II : OBJECTIVES OF THE NCC

9. Objectives of the NCC are:-
- (a) Reach out to the maximum youths through various institutions.
 - (b) Make NCC as an important part of the society.
 - (c) Teach positive thinking and attitude to the youths.
 - (d) Become a main source of National Integration by making NCC as one of the greatest cohesive force of our nation irrespective of any caste, creed, religion or region.
 - (e) Mould the youth of the entire country into a united, secular and disciplined citizens of the nation.
 - (f) Provide an ideal platform for the youth to showcase their potential in nation building.
 - (g) Instill spirit of secularism and united India by organizing National Integration Camps all over the country.
 - (h) Reach out to the youths of friendly foreign countries through Youth Exchange Programmes (YEP).

CONCLUSION

10. The NCC has come a long way and as a organization it has assumed a very important place in the country in grooming the youths to be a leader of tomorrow. Living upto its motto i.e "Unity and Discipline" it strives in its endeavour to meet all its objectives by bringing together the vibrant youths of the entire country.

LESSON PLAN : N 2
ORGANISATION, TRAINING AND NCC SONG

Period	-	One
Type	-	Lecture
Code	-	N 2
Term	-	I (SD/SW)

Training Aids

1. Computer Slides, Charts, Pointer, Black board & Chalk.

Time Plan

2.
 - (a) Introduction - 01 Min
 - (b) Organisation - 25 Min
 - (c) Training - 10 Min
 - (d) NCC Song - 03 Min
 - (e) Conclusion - 01 Min

INTRODUCTION

3. The present day NCC came into existence on 16 Apr 1948, through XXXI Act of Parliament. NCC was formally inaugurated on 15 Jul 1948, as soon as the schools and colleges reopened after summer vacation. The Girls Division of the NCC was raised in Jul 1949. On 01 Apr 1950, Air Wing was raised, with one Air squadron each at Bombay and Kolkata. The Naval Wing of the NCC was raised in Jul 1952, thus completing the true representation of all services in the Corps. Today the NCC has more than 13 Lakh strength.

AIM

4. To teach the cadets about the NCC Organisation, Training and the NCC Song.

PREVIEW

5. The class will be conducted in following parts:-
 - (a) Part I - Organisation of NCC
 - (b) Part II - Training of NCC
 - (c) Part III - NCC Song

PART I : ORGANISATION OF THE NCC

Organisation

6. The NCC is a voluntary organization which is administered through the Ministry of Defence. The Defence Secretary is overall in charge, who is responsible to the Govt of India for efficient functioning of the NCC and other matters.

7. At the Headquarters level, this organization is headed by an officer of the rank of Lieutenant General who is responsible for the functioning of the NCC in the country.

8. There are 17 Directorates located in the state capitals headed by an officer of the rank of a Major General / Brigadier or equivalent from the three Services. Depending upon the size of the state and growth of NCC in the states, Directorates have up to 14 Group Headquarters under them through which they exercise their command and control of the organisation in the state. Each group is headed by an officer of the rank of Brig / Colonel or equivalent known as Group Commander.

9. Each NCC Group Headquarters controls 5-7 NCC units / battalions, commanded by Colonel / Lieutenant Colonel or equivalent. Each battalion consists of companies which are commanded by the Associate NCC Officers (ANO) of the rank of Lieutenant, Captain or Major. In all, there are 95 Group Headquarters in the country who exercise control over a network of 667 Army Wing Units (including technical and girls unit), 60 Naval Wing Units and 61 Air Squadrons.

10. There are two training establishments namely Officers Training School, Kamptee and Women Officers Training School, Gwalior where professors and teachers from colleges and schools are specially trained to impart training to the cadets as Associate NCC Officers (ANOs).

11. Organisation and structure of NCC is as under:-

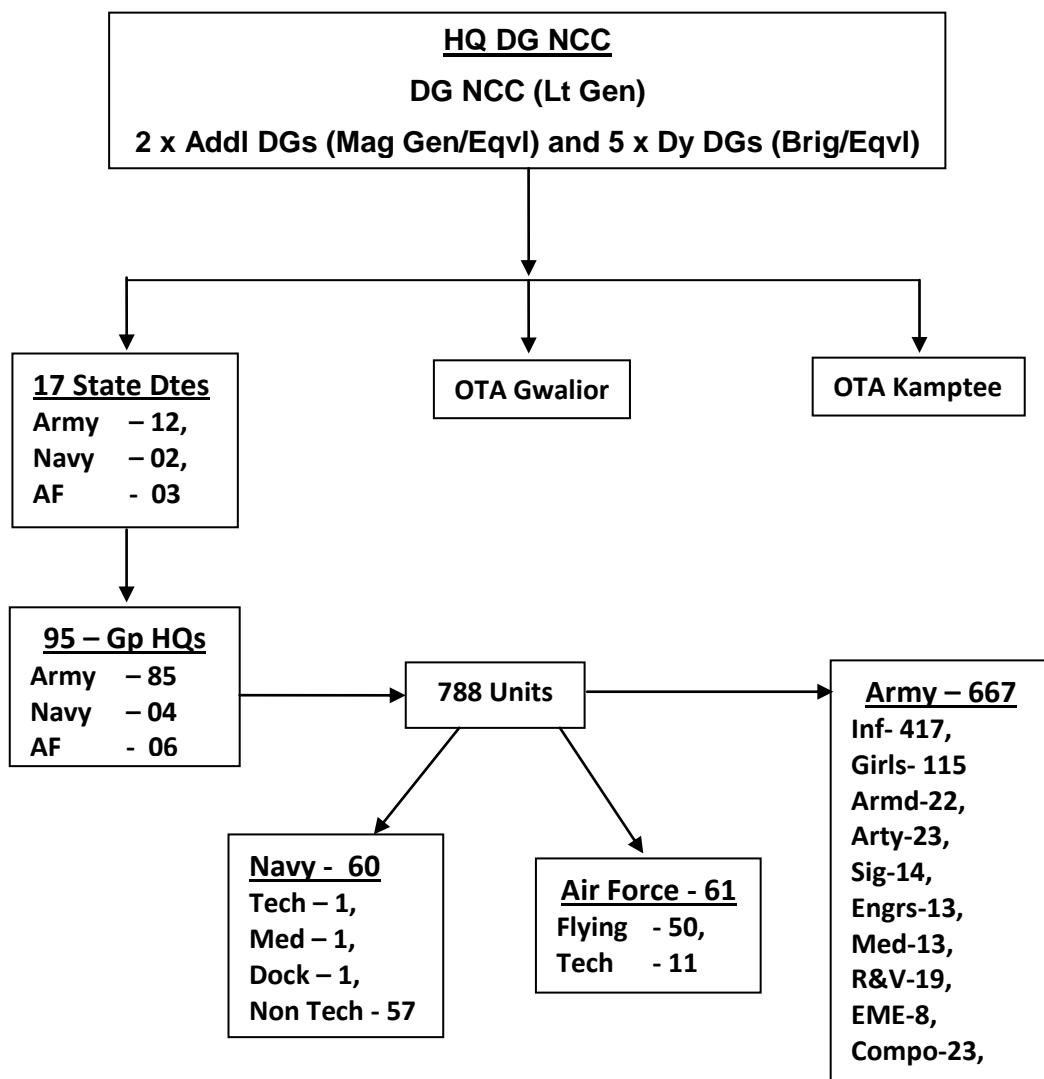

NCC Staff

12. NCC is staffed by the following:-
- (a) Regular officers drawn from the three services
 - (b) Whole Time Lady Officers (WTLO), who are from NCC.
 - (c) Associate NCC officers (ANO), who are professors and teachers.
 - (d) Girl Cadet Instructors (GCI), who are from NCC.
 - (e) Permanent Instructional (PI) Staff from army, navy and air force.
 - (f) Civilian Gliding Instructors.
 - (g) Civilian Staff.

PART II : TRAINING IN NCC**Importance of Training**

13. Good and structured training is an essential part of any organization like NCC and hence it is given due importance. A tremendous amount has been achieved by the corps through its well regulated system of intensive training which includes Basic, Advance and Specialised training, with major stress being laid on training camps.

14. **Training Activities.** Training activities of NCC can be broadly classified as under:-

- (a) **Institutional Training.** Training organised in schools and colleges as parades on a weekly / monthly basis.
- (b) **Camp Training.** Formal training organized as camps of 10-12 days duration.
- (c) **Attachment Training.** Formal training organized by attachment with army / naval / air force units or with officer training academies like IMA and OTA.
- (d) **Naval Wing Activities.** Seamanship, Navigation, Communication, Naval Warfare are taught to cadets. Swimming, Scuba Diving and Wind Surfing are other interesting activities.
- (e) **Air Wing Activities.** Airmanship, Aero modeling, Navigation, Air Frames, Aero Engines and Microlite Flying are taught to cadets.
- (f) **Remount & Veterinary Activities.** This activity is primarily meant for horsemanship and riding.

15. **Types of Camps.**

- (a) **Annual Training Camps (ATC).** These are held within the state under the aegis of respective NCC Directorates and are of 12 days duration for senior boys / girls and 10 days for junior boys / girls.
- (b) **Centrally Organised Camps (COC).** These are of an all India nature and are planned by HQ DGNCC in consultation with the Directorates nominated to conduct them. The centrally organized camps are :-
 - (i) Leadership Camps (Basic and Advance).

- (ii) Thal Sainik Camp (TSC).
- (iii) Vayu Sainik Camp (VSC).
- (iv) Nau Sainik Camps (NSC).
- (v) Rock Climbing Camp.
- (vi) National Integration Camps (NIC).
- (vii) RDC and PM's Rally.

(c) **Adventure Training and Sports**. These include mountaineering, sailing, para sailing, rafting, trekking, Valley of Flowers expedition, cycle expedition, desert safari, shooting and showjumping activities.

16. **Youth Exchange Programme (YEP)**. In this, selected cadets are sent to friendly foreign countries for a 10 day visit.

PART III : NCC SONG

17. The official song of the NCC – “Kadam Mila Ke Chal” was adopted in 1963. However, in 1974, a change was felt to catch the imagination of the youths and portray the true feelings of NCC. As a result the song was replaced by “Hum Sab Hindi Hain” which kept on playing in RDCs till the word ‘Hindi’ was replaced by ‘Bhartiya’ in 1980. The NCC song depicts the feelings of unity in diversity and exhorts everyone to march towards the single goal – all being INDIANS.

CONCLUSION

18. NCC as an organization has unified the youth, not only of our country, but has made significant efforts to interact with the youths of other country through YEPs, thus expanding the scope of its training and the ultimate goal of Unity.

LESSON PLAN : N 3
INCENTIVES TO CADETS

Period	-	One
Type	-	Lecture
Code	-	N 3
Term	-	I (SD/SW)

Training Aids

1. Computer Slides, Chart, Pointer, Black board & Chalk.

Time Plan

2. (a) Introduction - 05 Min
- (b) Incentives by Centre - 15 Min
- (c) Incentives by States - 15 Min
- (d) Conclusion - 05 Min

INTRODUCTION

3. Apart from grooming and preparing the youths for the future challenges in NCC, cadets are given various benefits in terms of job opportunities, scholarships and financial assistance in time of any tragedy while doing any NCC related activities. These incentives are announced from time to time by the Central and State Govts. These incentives are in the field of employment as well as academics and personal including medals, trophies, cash award etc. The best incentive being the vacancy reserved for 'C' certificate holders cadets for the commission as officer in the Indian army.

AIM

4. To acquaint cadets about Incentives given to the NCC the Centre and State Govts.

PREVIEW

5. The class will be conducted in following parts:-
 - (a) Part I - Incentives given by the Centre.
 - (b) Part II - Incentives given by the State.

PART I : INCENTIVES BY THE CENTRE GOVT

Concession in Employment

6. (a) **For 'C' Certificate Holders.** Specific vacancies in the Army, AF and Navy are reserved for NCC 'C' certificate holders. For officers there is no UPSC written exams. After application, the cadet is called directly for SSB interview, which he has to clear before final selection as per the merit list. The following vacancies are reserved by each service as officers :-
 - (i) **Army.** 64 seats per year at IMA and 100 seats per year at OTA.

- (ii) **Navy.** 06 seats per course through Naval SSB.
- (iii) **Air Force.** 10% vacancies in all courses through Air Force SSB.
- (b) 5-10% bonus marks for recruitment in ranks in Army, Navy and Air force.
- (c) Bonus marks for employment in Para Military Forces and Department of Telecommunication.
- (d) Can apply for gazetted post in CRPF if third division degree held by the cadet.
- (e) Preference in State Services and also in private sectors.
- (f) Employment within NCC as Whole Time Lady Officer, Girl Cadet Instructor, Aero and Ship Modeling Instructor.

Financial Assistance / Scholarships

7. Financial assistance and relief to cadets is provided by **Cadet Welfare Society (CWS) in case of any injury to the cadet or** to the NOK, in case of any fatality during NCC related activities. Details of the financial assistance are:-

	<u>NCC Activities</u>	<u>Death Cases</u>	<u>Permanent Disability</u>	<u>Temporary Disability</u>
(a)	High Risk	4,00,000/-	upto 4,00,000/-	upto 1,75,000/-
(b)	Other Activities	3,50,000/-	upto 3,50,000/-	upto 1,75,000/-

8. Other benefits provided by the CWS are:-

- (a) Scholarship to academically brilliant students.
- (b) Grant of Best Cadet Award of Rs 3500/- and 2nd Best Cadet Award of Rs 2500/- at each Group level.
- (c) Conduct sports and adventure activities.

9. **Scholarships.**

- (a) **Cadets Welfare Society (CWS).** CWS awards scholarship of Rs 6000/- per cadet for 1000 NCC cadets every year.
- (b) **Sahara Scholarship.** Sahara gives Rs 30,000/- for Professional and Other categories and Rs 12000/- for SD/SW.

PART II : INCENTIVES BY STATE GOVTS

10. The State-Wise Incentives given to NCC cadets are given below:-

S. No	State	Employment Benefits	Admission in Educational Institutions
1.	AP	Preference for NCC 'B'/C' certificate holders for recruitment in Police Service and Transport Department	<ul style="list-style-type: none"> • One seat reserved in degree and diploma courses and 5% seats for LLB courses in Osmania University • Seats in Govt. Polytechnics ,PG Degree/ Diploma Courses and Engineering Colleges • 0.25% seats in Medical Courses

2.	Bihar & Jharkhand	Bonus marks to NCC 'B' / 'C' certificate holders in the Police and Forest Department	Bonus marks are awarded to NCC Certificate holders for admission in various courses in the Universities of Patna, Ranchi, Mithila and Bhagalpur
3.	J & K	10% or one post, whichever is higher, reserved in non-gazetted service in Police, Home Guards, Forest and Excise Department for NCC 'C' certificate holders. Similar reservations are for Girl Cadets in Police and as nurses, receptionists and telephone operators	
4.	Karnataka & Goa		10% seats in Medical, 5 in Non-allopathic, 50 in Engineering, 10 in Technical, 8 in B.Ed., 3 in Post Graduation and 47 in Polytechnics for outstanding NCC Cadets
5.	Kerala & Lakshdweep		<ul style="list-style-type: none"> • Seats in Engineering Colleges, Polytechnics, Ayurveda College, Medical Colleges and Nursing • Bonus marks for Pre-Degree Courses, Degree Courses, Post Graduate Courses, B.Ed. Courses and Teachers Training Course • Weightage for admission to higher studies
6.	MP	Preference to 'C' certificate holders for recruitment in all state jobs	<ul style="list-style-type: none"> • Preference for admission to the postgraduate/ professional/ degree colleges • 10 Marks being added to final marks to NCC cadets selected for participation in Republic Day Camp
7.	Maharashtra		<ul style="list-style-type: none"> • 10 grace marks to NCC cadets appearing at various degree examinations by University of Mumbai • 2% mark to NCC cadets by Maharashtra University • 3 marks given for admission in medical colleges • 10 seats reserved in Engineering colleges for NCC cadets representing State in the All-India competition • Weightage of 4 marks for admission in ITI
8.	NER-Assam	Preference given to NCC 'B'/'C' certificate holders for recruitment to Police Service and Govt. Jobs	<ul style="list-style-type: none"> • Two seats reserved in diploma & certificate courses in engineering & tech. One seat each in Assam and Jorhat Engineering College
9.	Arunachal Pradesh	Preference in recruitment to the State Police Service	Relaxation of 5% marks for admission to educational institutions

10.	Manipur	Reservation of 10% posts in the Police Department	
11.	Meghalaya	Posts of women constable in state police force	
12.	Nagaland	Preference to NCC 'B' and 'C' certificate holders in State Police Force	Relaxation of 5% marks for admission to educational institutions including technical institution under State Govt.
13.	Tripura	Preference to NCC 'B' and 'C' certificate holders in Police service and Government jobs	
14.	Orissa	Preference for recruitment to the State Police Force	Additional weightage of marks over and above the aggregate marks obtained for admission in various colleges
15.	Haryana	Preference in Home Guard Department and State Police Force	
16.	H.P.		Weightage for admission to various courses of study in Himachal Pradesh University
17.	Punjab		Weightage of marks given for admission in various courses in State Govt. Polytechnics, Colleges and Universities
18.	Rajasthan	Preference in State Police Force	Weightage for the purpose of admission to various courses in
19.	TN and Andaman Nicobar	Consideration by Tamil Nadu Public Commission in Civil Services, exams Out of 12 marks for the oral test in the B.T. and P.G. Assistant recruitment/ appointment in Tamil nadu, ½ mark is awarded for NCC activities	One seat reserved in Under Graduate Course in each college and one seat in any Post Graduate Course and Polytechnic, where NCC Scheme is available
20.	Pondicherry	Preference in all Departments of Pondicherry especially in Police	A weightage of 2% of marks for B.A./ B.Sc./ B.Com. course
21.	UP	8% posts are reserved in State Government for part time NCC officers and NCC cadets who become disabled during the course of training	Bonus marks/ weightage by various Universities for admission in various Degree, B.Ed. and Post Graduation courses
22.	UK		One seat in each branch in Kumaon Engineering College, GB Pant Engineering College and Govt. Polytechnics and two seats each in Kumaon University and Garhwal University for B.Ed.

23.	WB & Sikkim	Weightage being given for enrolment in Police. 20% weightage is given to NCC cadets for recruitment in Home Guard	
-----	-------------	---	--

11. In the case of states like Delhi, Gujrat, Dadra Nagar Haveli, Chattisgarh and Mizoram, incentives in the form of concessions for employment, education are not being given. However, other incentives like scholarships and cash awards are being given in these States. The incentives keep changing from time to time. Hence, the cadets must keep themselves aware of the incentives published in various orders.

CONCLUSION

12. The youth of Independent India are extremely fortunate to have such an organization existing in the country which devotes vast amount of financial and physical resources towards their personality development, and thus is indeed a nursery for grooming of future leaders in various walks of life. The NCC offers relaxation in the selection criteria for employment in various armed forces, para-military forces as well as state government jobs; provides opportunities to work for NCC either in the form of GCI or WTLO. The teachers of various schools and colleges can also have the opportunities to be associated with any of the three wings i.e Army, Navy and Air force of NCC and guide cadets.

INDEX**NATIONAL INTEGRATION**

<u>Ser No</u>	<u>Lesson Code</u>	<u>Subject</u>	<u>Cat</u>	<u>Page No</u>
1.	NI-1	Religions, Culture, Traditions and Customs of India.	SD /SW	15
2.	NI-2	National Integration Importance and Necessity.	SD /SW	19
3.	NI-3	Freedom Struggle and Nationalist Movement in India.	SD /SW	22
4.	NI-4	National Interests, Objectives, Threats and Opportunities.	SD /SW	27
5.	NI-5	Problems / Challenges of National Integration.	SD /SW	31
6.	NI-6	Unity in Diversity.	SD /SW	34
7.	NI-7	National Integration Council.	SD /SW	37
8.	NI-8	Images / Slogans for National Integration.	SD /SW	41
9.	NI-9	Contribution of Youth in Nation Building.	SD /SW	47

LESSON PLAN : NI 1
RELIGIONS, CULTURE, TRADITIONS AND CUSTOMS OF INDIA

Period	-	Two
Type	-	Lecture
Code	-	NI 1
Term	-	I (SD/SW)

Training Aids

1. Computer, Projector, Charts, Pointer. Black Board & Chalk.

Time Plan

2.	(a)	Introduction	-	05 Min
	(b)	Religions and Culture of India	-	35 Min
	(c)	Customs and Traditions of India	-	35 Min
	(d)	Conclusion	-	05 Min

INTRODUCTION

3 India is a multi religious democratic country. There are six major religions in India with Hindus comprising of 83.5 %, Muslims 0.7 %, Christians 2.44 %, Sikhs 1.79 % and others 1.51 %.

4. The historical analysis has proved that religion has played an 'obstructive role' in the rise of nationalism. In ancient and mediaeval time it has worked as a system of exploitation. Under the British rule, religion acted as a main barrier against national unity. The public has now realized the fact that, religion is a private affair of an individual and it should not be mixed with political affairs of the state. That is why most of the advanced democratic states have adopted secularism in their constitution, which is a factor for unity in multi-religious societies like ours.

AIM

5. To acquaint the cadets about Religions, Culture, Traditions and Customs of India.

PREVIEW

6. The lecture will be conducted in following parts:-
 - (a) Part I - Religions and Culture of India.
 - (b) Part II - Customs and Traditions of India.

PART I : RELIGIONS AND CULTURE OF INDIA

Main Religions of India

7. **Hinduism.** Religion for the Hindus is experience or attitude of mind. It is not an idea but a power, not an intellectual proposition but a life conviction. It is consciousness of ultimate reality. Man becomes aware of God through experience. The source of Hindu thought is the Vedas. The

Hindus believe in meditation and yoga. The goal of religious quest is earned by intellectual and moral discipline. The Hindus believe in re-birth, spirit and salvation. Perfection in life as per Hinduism is attained through knowledge of truth. The theory of Hinduism lays stress on Bhakti, Karma and Re-birth.

8. **Islam**. Islam means 'Submission' or resignation to Allah (God). The Quran, the highest authority is revealed and created being the eternal word of God incarnate. All the prophets from Adam to Mohammad and the books revealed to them are regarded as religious heritage of Islam. Muslims have to bear witness to the oneness of God and message of Muhammed and have to observe prayer five times daily with a weekly Juma prayer on Friday noon. They keep dawn to dusk fast for purity of soul in the ninth month of Ramzan of the Islamic year. Muslims and who can afford, make pilgrimage to Haj once in life time. The Islamic teaching highlights the purity of life, charity to the poor and spread of brotherhood.

9. **Christianity**. Christianity was founded by Jesus Christ, commands the largest following in the world. Christ was born in 4 BC in Judaea. He started preaching about the kingdom of God when he was thirty. His activities roused the opposition of the Jewish high priests who accused him. He was crucified on the orders of Pontius Pilate, the Roman Governor. Christianity preaches charity, love and peace. The message of Jesus Christ is given in the Holy Bible. Christianity is not a religion but a way of life, which guides the actions and life for mental peace and love of humanity.

10. **Jainism**. Jainism derives its name from Jaina (the Conqueror). Mahavira belonged to a princely family in Vaishali. At the age of 30 he renounced the world and spent 12 years in austerity and meditation in search of truth. At the age of 47, while meditating, he received enlightenment. As per Jainism teachings, anger, pride, deception and greed must be counteracted by the ten best virtues such as forgiveness, humility, straight forwardness, contentment, truthfulness, restraint, austerity, purity, chastity and renunciation. To keep himself steady on path of liberation and to destroy karma, a monk has to bear all the trouble that might cause him pains. The monk has to practice austerity external and internal. It is pure meditation which ultimately leads to liberation.

11. **Buddhism**. Buddhism was founded by Gautam Buddha who was son of Indian Prince Suddhodan. The sorrow and suffering of the world tormented his heart and he abandoned his house and started pursuit for enlightenment. Gautam found enlightenment while meditating under a Pipal tree at the age of 42. Buddha preached that emancipation from cycle of re-birth i.e Nirvana can be attained by path of self purification, with doctrine of love and mercy. Buddhism is essentially a religion of kindness, humanity and equality. It denounces all claims to superiority on grounds of birth or caste.

12. **Sikhism**. God the original Guru, imparted his message to his disciple Nanak, who having absorbed the divine spirit became the Guru himself. The message is known as Gurmat. He who follows the teaching of Gurmat is a pure person and known as Sikh. The same spirit was passed on to the successive Gurus and ultimately the divine spirit has been passed onto the sacred script of 'Guru Granth Saheb'. The teachings of Sikhism are that God is one. Equality in society and leading a life of purity are important. The institution of Gurudwara and common kitchen (langar) are noble examples of equality in Sikhism.

Culture of India

13. **Dimensions of Indian Culture**. Various races have been coming to India from time immemorial. The civilizations of these races differed a great deal from one another. On entering India, they had conflicts with the earlier inhabitants of the country. These conflicts affected their respective cultures and through the process of assimilation and synthesis, Indian culture grew all the more richer.

14. **Arrival of Various Races in India and their Effects.**

(a) **Negrito Race.** According to J H Hunton, the oldest race reaching India was Negrito. They were not very high from the point of view of civilization. They did not know how to make use of the instruments made of stones and bones, how to cultivate the land, how to make earthen wares or how to build houses. They are now found only in Andaman Islands.

(b) **Proto-Australoid Race.** After the Negrito race, came the Proto-Australoid or the primitive Australian race. They are specially found in Central India or in South - East India in the present age. They are also called 'Austriac' in English and 'Agneya' in Hindi. Santhal, Munda, Birho, Asur, Kobra, Coorg, Jaung and such other tribes are related to the Proto-Australoid race. The people of Australoid race influenced the material and religious life in India. Indians learnt, how to cultivate the land with the help of pick - axe and to grow rice, bananas, coconuts, brinjals, betel leaves, lemons, jamboo fruit and cotton from them. In the religious field, they brought to India many things like the belief in rebirth, various fabulous stories about the origin of creation, a myth about incarnation of God in a tortoise, belief about the existence of Gods in stones, the worship of various creatures like snakes, crocodiles, monkeys etc. The interesting stories in Mahabharat and Ramayan about Vasuki, the ruler in 'Patal Lok', the origin of the creation from snakes and eggs, interesting stories about Ganesh, etc have been taken from the myths of this race. Perhaps, this very race taught the Indians, how to count the dates according to moon phases and fixation of sacred festivals etc.

(c) **Dravidian Race.** The people of Dravidian or Mediterranean race came to India after the Proto-Australoid race. They were more civilized than the people of both the races which came to India earlier. Under their influence new Gods and new methods of worship came to the Indian religious field. In fact, the word 'Pooja' (worship), belongs to Dravidian language. The acceptance of an idol, as representative of some God, to offer it flowers and tree leaves, to offer it vermilion and sandal paste, to burn incense before it to ring bells, to sing to dance before it, to offer and accept sweets and such other ways of worship were given to India by the Dravidians. The chief new Gods, who began to be worshiped under the influence of the Dravidians, were Shiva, Uma, Kartikeya, Hanuman, Shitla and Ganesh etc. Under the Dravidian influence, the number of Gods increased. Gods and Goddesses, village God, family God and other Gods of Hindu religion supposed to be 330 million in number, are all the result of their influence. The importance of the sacred places of worship increased under the influence of the Dravidians. In the same way, they also preached the worship of the trees, like workshop of tulsi, banyan, peepal, bel and many others. It was the Dravidians who gave Indians the festivals of Holi and Basant.

(d) **Aryan Race.** Aryans made the greatest contribution towards the development of Indian culture. It is their tongue which is in use today in major parts of India. Their Vedas are the main roots of Indian culture. The contribution of the Aryans towards the Indian culture has been thus described by Dr Jadunath Sarkar as a feeling of sympathy and adjustment, a wonderful evolution of science and philosophy, fixation of adjustment among different castes through their principle of 'Varna' system and the spread of civilization among the demons and wild tribes through 'Tapovan' system.

(e) **Muslim Race.** Muslims came to India after the Aryans. In his book titled 'Influence of Islam on Indian Culture', Dr Tarachand has written that the influence of Muslims on the various parts of Indian life has been very great and this influence has been seen specially on Hindu customs, on the very minute things of their family, on music, dress, cooking methods, marriage traditions, festivals, fairs and on the institutions and manners of the Maratha, Rajput and Sikh courts.

(f) **Influence of the British.** After the Muslims, the British deeply influenced all aspects of Indian culture. The spread of English language brought hundreds of English words into the Indian languages. The influence of western culture on the prose, novel,

one-act plays and poetry, etc in Indian literature can be clearly seen. Western education created a wave of reformation in the whole country. On the one hand, the ideas of equality, freedom and nationality helped in uprooting the social evils like Sati custom, killing of female child, child marriage and prohibition of widow marriage, on the other hand, they created a political awakening in the country. The present form of administration in India is the outcome of the great influence of the British ideology. The present economic organization, joint stock companies, managing agencies, big factories, production through machines, railways, telegraphs, telephone, aeroplanes and other means of conveyance and communication were brought to India from the west. This influence has regularly been on the increase and it is also needed for the country's progress, although its assimilation is equally necessary.

PART II : CUSTOMS AND TRADITIONS OF INDIA

15. India is a multiracial, multilingual civilization with rich culture heritage and has provided peaceful atmosphere for the development of many religions. Indian culture and customs are influenced by these religions. The customs of India depict very colourful panorama. There are certain customs which are prevalent in a particular religion and some are common to all religions of the country.

16. **Festivals**. Indian festivals are famous in the world. Most of the festivals are related to the change of weather and crop harvesting since India is an agro based economy. The most famous Indian festivals are Diwali, Holi, Dussehra and Basant Panchami. There are certain festivals which are prevalent in particular regions only like Bihu in Assam, Baishakhi in Punjab etc.

17. **Customs and Traditions**.

(a) Indian customs are of various types mostly related to local customs, caste customs and family customs. There are different customs of Hindu marriage as compared to a Muslim marriage or a Sikh marriage. Similarly, there are different customs of festival celebrations. All these customs have been protected by law.

(b) Certain religious customs pertain to a particular religion only, like Mundan ceremony in Hindus and Naming ceremony in Sikhs. These customs have religious value and are a means of entertainment also.

(c) There are some customs regarding dresses and ornaments of women. These are associated with particular regions, which give a very colorful dimension to Indian customs and traditions. Similarly, all regions have their distinctive ornaments.

(d) India being a big country with different races and religions, has rich customs related to festivals, religious ceremonies, dresses, marriages, architecture, painting, song, dance and food habits. The customs and traditions of India though varied, has a binding force in them, which ultimately serves as a unifying factor of Secular India.

CONCLUSION

18. India being a multi lingual, multi racial and multi religious secular society, has a vast pool of customs and traditions. Today, most of the modern thinking has broken all barriers in society. People have become more tolerant and celebrate most festivals, even if they happen to belong to other religions and they whole heartedly join all celebrations.

LESSON PLAN : NI 2
NATIONAL INTEGRATION : IMPORTANCE AND NECESSITY

Period	-	One
Type	-	Lecture
Code	-	NI 2
Term	-	I (SD/SW)

Training Aids

1. Computer, Projector, Charts, Pointer, Black Board & Chalk.

Time Plan

2.	(a)	Introduction	-	05 Min
	(b)	Importance of National Integration	-	15 Min
	(c)	Necessity of National Integration	-	15 Min
	(d)	Conclusion	-	05 Min

INTRODUCTION

3. Indian civilisation is one of the oldest civilisations in the world. In the past people belonging to different races and religions came and settled here. They brought with them their distinctive language and life style. Different tribes with their distinct languages intermingled with various tribes of our country. That is why our culture is described as an example of composite culture. It is made up of all communities, races and religions.

AIM

4. To acquaint the cadets about National Integration, its Importance and Necessity.

PREVIEW

5. The lecture will be conducted in following parts:-
 - (a) Part I - Importance of National Integration.
 - (b) Part II - Necessity of National Integration.

PART I : NATIONAL INTEGRATION AND ITS IMPORTANCE

National Integration

6. National integration means a feeling of togetherness and unity among the people of a country. It also means an atmosphere in which all citizens, irrespective of their caste, religion and region live together peacefully. It refers to integration in all respects, social political, economic and above all emotional. In an integrated country people share common goals. They all work together and co-operate with each other for the prosperity of the nation.

7. We must understand that national integration does not mean uniformity of all. It does not stand for uniformity of religion, dress and food habits etc. It means both, preservation of diverse cultures and, at the same time living and working in harmony with each other. No country or society can survive if its people do not remain united. The feeling of togetherness and a sense of belonging are absolutely necessary for a nation to survive. Such a feeling can only be generated through the process of integration. Thus national integration is a positive concept which provides strength to the people to fight against all evil forces. It provides a congenial condition in which people can make good progress.

Importance

8. National integration has assumed greater importance in the recent years due to the fast changing ethos and moral values in the society. The need for national integration was probably never felt before as is felt today. The turbulent atmosphere and the deteriorating law and order situation in the country due to various religious, social and political factors have led to the realisation of the necessity of national integration.

9. The realisation of its importance in itself is a step in the desired direction. The Government having appreciated the urgency and seriousness of the subject is taking positive steps towards achieving the national integration. NCC, one of the prime organisations of the country training the youth, the future of this great nation, makes the ideal ground to start with. National integration has been made part and parcel of NCC training. Lot of emphasis is laid on national integration by conducting national level camps and number of other activities where cadets from all over the country participate.

PART II : NECESSITY OF NATIONAL INTEGRATION

10. National integration is necessary particularly in a country like India, where people with different languages, religions, races and culture are required to be weaved together. The unity in diversity of which we are proud of can only be maintained if, we have the understanding and respect for each other's religion, customs and traditions. If we have to survive as a nation and safeguard our sovereignty and national integrity, we have to remain united. National integration is a pre-requisite for the survival and prosperity of any nation and hence needs no emphasis. National integration is therefore a basic necessity for survival of any nation such as:-

- (a) Maintenance of sovereignty and territorial integrity of the nation.
- (b) Maintenance of peace and harmony.
- (c) Growth and development of the nation.
- (d) Eradication of poverty and illiteracy.
- (e) Internal security and law and order.
- (f) Culture and religious development.
- (g) Economic and industrial growth.
- (h) Attract foreign investment and increase import and export.
- (j) Exchange of technological know-how and culture .
- (k) Dignity and self respect as a nation.
- (l) Welfare and well-being of the people.

- (m) Foreign relations and better standing among the nations of the world.

CONCLUSION

11. It is the duty of each and every citizen of our country to strive to achieve unity in spite of diversity and further cement it. We must remember that there should be no divisions between North and South or East and West of India. There is only one India of which we all Indians are inheritors. We are Indian first and Indians last.

LESSON PLAN : NI 3
FREEDOM STRUGGLE AND NATIONALIST MOVEMENT IN INDIA

Period	-	Two / One
Type	-	Lecture
Code	-	NI 3
Term	-	I / II (SD/SW)

Training Aids

1. Computer, Projector, Charts, Pointer, Black Board & Chalk.

Time Plan

2.

(a)	Introduction	-	05 Min
(b)	The Indian Mutiny of 1857	-	20 Min
(c)	End of East India Company	-	20 Min
(d)	Formation of Indian National Congress	-	30 Min
(e)	Conclusion	-	05 Min

INTRODUCTION

3. In ancient times, people from all over the world were keen to come to India. The Aryans came from Central Europe and settled down in India. The Persians followed by the Iranians and Parsis immigrated to India. Then came the Moghuls and they too settled down permanently in India. Chengis Khan, the Mongolian, invaded and looted India many times. Alexander the Great too, came to conquer India but went back after a battle with Porus. Hue-en Tsang from China came in pursuit of knowledge and to visit the ancient Indian universities of Nalanda and Takshila. Columbus wanted to come to India, but instead landed on the shores of America. Vasco da Gama from Portugal came to trade his country's goods in return for Indian species. The French came and established their colonies in India.

4. Lastly, the Britishers came and ruled over India for nearly 200 years. After the battle of Plassey in 1757, the British achieved political power in India. Their supremacy was established during the tenure of Lord Dalhousie, who became the Governor- General in 1848. He annexed Punjab, Peshawar and the Pathan tribes in the north-west of India. And by 1856, the British conquest and its authority were firmly established. While the British power gained its heights during the middle of the 19th century, the discontent among the local rulers, the peasantry, the intellectuals, common masses as also of the soldiers who became unemployed due to the disbanding of the armies of various states, became widespread. This soon broke out into a revolt which assumed the dimensions of the 1857 Mutiny.

AIM

5. To acquaint the cadets about the Freedom Struggle and Nationalist Movement of India.

PREVIEW

6. The Class will be conducted in the following parts:-
- (a) Part I - Indian Mutiny of 1857.
 - (b) Part II - End of East India Company.
 - (c) Part III - Indian Nationalist Movement.

PART I : THE INDIAN MUTINY OF 1857

7. The conquest of India, which could be said to have begun with the Battle of Plassey (1757), was practically completed by the end of Dalhousie's tenure in 1856. It had been, by no means, a smooth affair as the simmering discontent of the people manifested itself in many localized revolts during this period. However, the Mutiny of 1857, which began with a revolt of the military soldiers at Meerut, soon became widespread and posed a grave challenge to the British rule. Even though the British succeeded in crushing it within a year, it was certainly a popular revolt in which the Indian rulers, the masses and the militia participated so enthusiastically, that it came to be regarded as the First War of Indian Independence.

8. Introduction of 'zamindari system' by the British, where the peasants were ruined through exorbitant charges made from them by the new class of landlords. The craftsmen were destroyed by the influx of the British manufactured goods. The religion and the caste system which formed the firm foundation of the traditional Indian society was endangered by the British administration. The Indian soldiers as well as people in administration could not rise in hierarchy as the senior jobs were reserved for the Europeans. Thus, there was all-round discontent and disgust against the British rule, which burst out in a revolt by the 'sepoys' at Meerut whose religious sentiments were offended when they were given new cartridges greased with cow and pig fat, whose covering had to be stripped out by biting with the mouth before using them in rifles. The Hindu as well as the Muslim soldiers, who refused to use such cartridges, were arrested, which resulted in a revolt by their fellow soldiers on 9 May 1857.

9. The rebel forces soon captured Delhi and the revolt spread to a wider area and there was uprising in almost all parts of the country. The most ferocious battles were fought in Delhi, Awadh, Rohilkhand, Bundelkhand, Allahabad, Agra, Meerut and western Bihar. The rebellious forces under the commands of Kanwar Singh in Bihar and Bakht Khan in Delhi gave a stunning blow to the British. In Kanpur, Nana Sahib was proclaimed as the Peshwa and the brave leader Tantya Tope led his troops. Rani Lakshmibai was proclaimed the ruler of Jhansi who led her troops in the heroic battles with the British. The Hindus, the Muslims, the Sikhs and all the other brave sons of India fought shoulder to shoulder to throw out the British. The revolt was controlled by the British within one year, it began from Meerut on 10 May 1857 and ended in Gwalior on 20 June 1858.

PART II : END OF THE EAST INDIA COMPANY

10. Consequent to the failure of the Revolt of 1857 rebellion, one also saw the end of the East India Company's rule in India and many important changes took place in the British Government's policy towards India which sought to strengthen the British rule through winning over the Indian princes, the chiefs and the landlords. Queen Victoria's Proclamation of 1 November 1858, declared that thereafter India would be governed by and in the name of the British Monarch through a Secretary of State.

11. The Governor General was given title of Viceroy, which meant the representative of the Monarch. Queen Victoria assumed the title of the Empress of India and thus gave the British Government unlimited powers to intervene in the internal affair of the Indian states. In brief, the British supremacy over India, including the Indian States, was firmly established. The British gave their support to the loyal princes, zamindar and local chiefs but neglected the educated people and

the common masses. They also promoted the other interests like those of the British merchants, industrialists, planters and civil servants. The people of India, as such, did not have any say in running the government or formulation of its policies. Consequently, people's disgust with the British rule kept mounting, which gave rise to the birth of Indian National Movement.

12. The leadership of the freedom movement passed into the hands of reformists like Raja Rammohan Roy, Bankim Chandra and Ishwar Chandra Vidyasagar. During this time, the binding psychological concept of National Unity was also forged in the fire of the struggle against a common foreign oppressor.

13. Raja Rammohan Roy (1772-1833) founded the Brahmo Samaj in 1828 which aimed at purging the society of all its evil practices. He worked for eradicating evils like sati, child marriage and purdah system, championed widow marriage and women's education and favoured English system of education in India. It was through his effort that sati was declared a legal offence by the British.

14. Swami Vivekananda (1863-1902) the disciple of Ramakrishna Paramahansa, established the Ramkrishna Mission at Belur in 1897. He championed the supremacy of Vedantic philosophy. His talk at the Chicago (USA) Conference of World Religions in 1893 made the westerners realize the greatness of Hinduism for the first time.

PART III : NATIONALIST MOVEMENT IN INDIA

Formation Of Indian National Congress (INC)

15. The foundations of the Indian National Movement were laid by Surendranath Banerjee with the formation of Indian Association at Calcutta in 1876. The aim of the Association was to represent the views of the educated middle class, inspire the Indian community to take the value of united action. The Indian Association was, in a way, the forerunner of the Indian National Congress, which was founded, with the help of A.O. Hume, a retired British official. The birth of Indian National Congress (INC) in 1885 marked the entry of new educated middle-class into politics and transformed the Indian political horizon. The first session of the Indian National Congress was held in Bombay in December 1885 under the president ship of Womesh Chandra Banerjee and was attended among others by Badr-uddin-Tyabji.

16. At the turn of the century, the freedom movement reached out to the common unlettered man through the launching of the "Swadeshi Movement" by leaders such as Bal Gangadhar Tilak and Aurobindo Ghose. The Congress session at Calcutta in 1906, presided by Dadabhai Naoroji, gave a call for attainment of 'Swaraj' a type of self-government elected by the people within the British Dominion, as it prevailed in Canada and Australia, which were also the parts of the British Empire.

17. Meanwhile, in 1909, the British Government announced certain reforms in the structure of Government in India which are known as Morley-Minto Reforms. But these reforms came as a disappointment as they did not mark any advance towards the establishment of a representative Government. The provision of special representation of the Muslim was seen as a threat to the Hindu-Muslim unity on which the strength of the National Movement rested. So, these reforms were vehemently opposed by all the leaders, including the Muslim leader Muhammad Ali Jinnah. Subsequently, King George V made two announcements in Delhi: firstly, the partition of Bengal, which had been effected in 1905, was annulled and, secondly, it was announced that the capital of India was to be shifted from Calcutta to Delhi.

18. The disgust with the reforms announced in 1909 led to the intensification of the struggle for Swaraj. While, on one side, the activists led by the great leaders like Bal Gangadhar Tilak, Lala Lajpat Rai and Bipin Chandra Pal waged a virtual war against the British, on the other side, the revolutionaries stepped up their violent activities. There was a widespread unrest in the country. To add to the already growing discontent among the people, Rowlatt Act was passed in 1919, which

empowered the Government to put people in jail without trial. This caused widespread indignation, led to massive demonstration and hartals, which the Government repressed with brutal measures like the Jaliawalla Bagh massacre, where thousands of unarmed peaceful people were gunned down on the order of General Dyer.

19. **Jalianwala Bagh Massacre.** Jalianwala Bagh massacre of 13 April 1919, was one of the most inhuman acts of the British rulers in India. The people of Punjab gathered on the auspicious day of Baisakhi at Jalianwala Bagh, adjacent to Golden Temple (Amritsar), to lodge their protest peacefully against persecution by the British Indian Government. General Dyer appeared suddenly with his armed police force and fired indiscriminately at innocent empty handed people leaving hundreds of people dead, including women and children.

20 After the First World War (1914-1918), Mohandas Karamchand Gandhi became the undisputed leader of the Congress. During this struggle, Mahatma Gandhi had developed the novel technique of non-violent agitation, which he called 'Satyagraha', loosely translated as 'moral domination'. Gandhi, himself a devout Hindu, also espoused a total moral philosophy of tolerance, brotherhood of all religions, non-violence (ahimsa) and of simple living. With this, new leaders like Jawaharlal Nehru and Subhash Chandra Bose also emerged on the scene and advocated the adoption of complete independence as the goal of the National Movement.

The Non-Cooperation Movement

21 The Non-Cooperation Movement was pitched in under leadership of Mahatma Gandhi and the Indian National Congress from September 1920 to February 1922, marking a new awakening in the Indian Independence Movement. After a series of events including the Jallianwala Bagh Massacre, Gandhiji realised that there was no prospect of getting any fair treatment at the hands of British, so he planned to withdraw the nation's co-operation from the British Government, thus launching the Non-Cooperation Movement and thereby marring the administrative set up of the country. This movement was a great success as it got massive encouragement to millions of Indians. This movement almost shook the British authorities.

Simon Commission

22. The Non-cooperation movement failed. Therefore there was a lull in political activities. The Simon Commission was sent to India in 1927 by the British Government, to suggest further reforms in the structure of Indian Government. The Commission did not include any Indian member and the Government showed no intention of accepting the demand for Swaraj. Therefore, it sparked a wave of protests all over the country and the Congress as well as the Muslim League gave a call to boycott it under the leadership of Lala Lajpat Rai. The crowds were lathi charged and Lala Lajpat Rai, also called Sher-e-Punjab (Lion of Punjab) died of the blows received in an agitation.

Civil Disobedience Movement

23. Mahatma Gandhi led the Civil Disobedience Movement that was launched in the Congress Session of December 1929. The aim of this movement was a complete disobedience of the orders of the British Government. During this movement it was decided that India would celebrate 26th January as Independence Day all over the country. On 26th January 1930, meetings were held all over the country and the Congress tricolour was hoisted. The British Government tried to repress the movement and resorted to brutal firing, killing hundreds of people. Thousands were arrested along with Gandhiji and Jawaharlal Nehru. But, the movement spread to all the four corners of the country and following this, Round Table Conferences were arranged by the British, and Gandhiji attended the second Round Table Conference at London. But nothing came out of the conference and the Civil Disobedience Movement was revived.

24. During this time, Bhagat Singh, Sukhdev and Rajguru were arrested on the charges of throwing a bomb in the Central Assembly Hall (which is now Lok Sabha) in Delhi, to demonstrate against the autocratic alien rule. They were hanged to death on March 23, 1931.

Quit India Movement

25. In August 1942, Gandhiji started the 'Quit India Movement' and decided to launch a mass civil disobedience movement 'Do or Die' call to force the British to leave India. The movement was followed, nonetheless, by large-scale violence directed at railway stations, telegraph offices, government buildings, and other emblems and institutions of colonial rule. There were widespread acts of sabotage, and the government held Gandhi responsible for these acts of violence, suggesting that they were a deliberate act of Congress policy. However, all the prominent leaders were arrested, the Congress was banned and the police and army were brought out to suppress the movement. Meanwhile, Netaji Subhash Chandra Bose, who stealthily ran away from the British detention in Calcutta, reached foreign lands and organized the Indian National Army (INA) to overthrow the British from India.

26. The Second World War broke out in September of 1939 and without consulting the Indian leaders, India was declared a warring state (on behalf of the British) by the Governor General. Subhash Chandra Bose, with the help of Japan, preceded fighting the British forces and not only freed Andaman and Nicobar Islands from the Britishers but also entered the north-eastern border of India. But in 1945, Japan was defeated and Netaji proceeded from Japan, through an aeroplane to a place of safety but, met with an accident and, it was given out that he died in that air-crash itself. "Give me blood and I shall give you freedom" - was one of the most popular statements made by him, where he urges the people of India to join him in his freedom movement.

Partition of India and Pakistan

27. At the conclusion of the Second World War, the Labour Party, under Prime Minister Clement Richard Attlee, came to power in Britain. The Labour Party was largely sympathetic towards Indian people for freedom. A Cabinet Mission was sent to India in March 1946, which after a careful study of the Indian political scenario, proposed the formation of an interim Government and convening of a Constituent Assembly comprising members elected by the provincial legislatures and nominees of the Indian states. An interim Government was formed headed by Jawaharlal Nehru. However, the Muslim League refused to participate in the deliberations of the Constituent Assembly and pressed for the separate state for Pakistan. Lord Mountbatten, the Viceroy of India, presented a plan for the division of India into India and Pakistan, and the Indian leaders had no choice but to accept the division, as the Muslim League was adamant.

28. Thus, India became free at the stroke of midnight, on 14 August 1947. Since then, every year India celebrates its Independence Day on 15th August. Jawaharlal Nehru became the first Prime Minister of free India and continued his term till 1964. Giving voice to the sentiments of the nation, Prime Minister, Pandit Jawaharlal Nehru said, Long years ago we made a tryst with destiny, and now the time comes when we will redeem our pledge, not wholly or in full measure, but very substantially. At the stroke of the midnight hour, when the world sleeps, India will awake to life and freedom. A moment comes, which comes but rarely in history, when we step out from the old to the new, when an age ends and when the soul of a nation, long suppressed, finds utterance.... We end today a period of ill fortune, and India discovers herself again.

CONCLUSION

29. Earlier, a Constituent Assembly was formed in July 1946, to frame the Constitution of India and Dr Rajendra Prasad was elected its President. The Constitution of India which was adopted by the Constituent Assembly on 26th November 1949. On January 26, 1950, the Constitution came into force and Dr Rajendra Prasad was elected the first President of India.

LESSON PLAN : NI 4
NATIONAL INTERESTS, OBJECTIVES, THREATS AND OPPORTUNITIES

Period	-	One
Type	-	Lecture
Code	-	NI 4
Term	-	II (SD/SW)

Training Aids

1. Computer, Projector, Pointer, Black Board & Chalk.

Time Plan

2. (a) Introduction - 05 Min
- (b) National Interests & Objectives - 15 Min
- (c) Threats and Opportunities - 15 Min
- (d) Conclusion - 05 Min

INTRODUCTION

3. India has inherited the federal structure from the Government of India act, 1935, which prescribed a federal type union of autonomous provinces, whose governments were to derive their powers directly from the crown. Such a decision was taken because, during the post independence era, India was divided into various segments and empowering them could hamper the democratic working of the country. It was also believed that the sound economic development of the country required centralized planning without any hindrance from the state. As India is a multi-lingual, multi-religious and multi-racial country, we all Indians should rise above vested partisan interests and strive towards the welfare of the country.

AIM

4. To acquaint the cadets about the National Interests, Objectives, Threats and Opportunities.

PREVIEW

5. The lecture will be conducted in following parts:-
 - (a) Part I - National Interests & Objectives.
 - (b) Part II - Threats and Opportunities.

PART I : NATIONAL INTERESTS & OBJECTIVES

National Interests

6. Every nation, with whatever form of government, has certain political, social and economic interests and objectives to achieve overall development, prosperity, progress, nationalism and

international recognition. To attain such objectives certain national interests are pre-requisites, which are as follows:-

- (a) **Sovereignty**. Foremost interest of the nation is to be autonomous and remain independent.
- (b) **Integrity**. The nation should be full, indivisible and have a well-defined territory.
- (c) **Unity**. The nation should be a secular union of states with political power belonging to a central confederate authority, with united and undivided goals without factional, sectarian or fanatical prejudices. It should be tolerant towards caste, colour, creed, religion and language of each other.
- (d) **Security**. The nation must ensure safety, territorial integrity and protection of the state against external threat or subversion.

National Objectives

7. India is a developing country. It has made rapid progress in all the spheres after its independence, viz, agriculture, industrialisation, urbanization etc. To visualise what India would be in future in all spheres is not an easy task. While ultimate objectives and millennium goals of the nation lie ahead, the basic objectives are found in the Directive Principles of State Policy enshrined in the Constitution of India which took effect when India became Republic. Directive Principles of State Policy lays down a code of conduct for the administrators of India in the discharge of their responsibilities as agents of the sovereign nation. They guide the path which will lead the people of India to achieve the noble ideals which the preamble of the constitution proclaim justice, social, economic and political, liberty, equality and fraternity.

8. There are 16 articles of the constitution from 36-51 that deal with the Directive Principles of State Policy. Important ones out of these are as follows:-

- (a) To ensure and protect a social order which stands for the welfare of the people.
- (b) Separation of judiciary from the executive.
- (c) Protection of national monuments.
- (d) Protection and improvement in environment, forests and wild life.
- (e) Organise agriculture and animal husbandry on modern and scientific lines.
- (f) Improvement of public health.
- (g) Prohibition of intoxicating drinks and drugs.
- (h) Promotion of educational and economic interests of weaker sections of the people.
- (j) To have uniform code of law irrespective of caste, creed, colour or religion.
- (k) Participation of workers and labourers in labour law.
- (l) Promotion of cottage industries.
- (m) Provision of maternity relief.

- (n) Education to all.
 - (o) Equal justice to all.
 - (p) Equal pay for equal work for both men and women.
 - (q) Adequate means of livelihood to all citizens.
9. Apart from the above Directive Principles, current objectives of our nation are as follows:-
- (a) Self sufficiency in nuclear- power.
 - (b) Availability of reliable power supply for farming and industries.
 - (c) Production of goods for world markets.
 - (d) Balancing growth in both public and private sector.
 - (e) Modernization of villages, linking with roads and provision of electricity to all villages.

PART II : THREATS AND OPPORTUNITIES

Threats

10. Certain factors stand against the all round integration of our nation, which impedes our progress towards national integration. The cadets need to understand the following factors, in order to successfully tackle them, and play their part in achieving the goals that align with national interest:-

- (a) **Regionalism.** Regionalism gives more importance to one's own region than to one's nation. When regionalism is linked with language and religion it creates regional interests rather than national interests. This creates parochialism among the people.
- (b) **Casteism.** Casteism is a divisive force. One section considers another section as inferior. They are exploited. Positions and opportunities are monopolized by a particular section. It creates enmity among the other castes. Caste organizations interfere in politics. They function as pressure groups and obtain benefits undeservedly. These factors prevent national integration.
- (c) **Communalism.** Communalism is not believing in any particular religion or observing its rites. Excessive affinity to one's own religion transforms into hatred towards other religions. Thus religious fanaticism arises. When religion, caste and race are used to make social and political gains, it is called communalism. The real cause of communalism lies in political and economic factors. The partition of India is an instance for the intervention of religion in politics.
- (d) **Linguistic Claims.** We have seen that the Indian constitution recognises 22 languages. Hindi is the official language and English is the link language. About 2000 languages are spoken by the various sections of the Indian people. Another problem faced by India was the linguistic reorganization of the states. In 1956 the states were re-organised on linguistic basis. Agitations are going on in many parts of India demanding state re-organisation. Linguistic jingoism has become an important factor which hinders national integration.

(e) **Extremism.** The extremist movements going on in different parts of the country are yet another challenge to national integration. You must have heard about naxalite movement or Maoist movement. These movements quite often use violence, create fear in public life, cause loss of lives of government personnel and people and destroy public property. Mostly the youth participate in such movements. The basic reason for taking up arms by the youth is the continuing state of socio-economic deprivations. Moreover, the day-to-day humiliation, denial of justice, human rights violations, various kinds of exploitation and political marginalization prompt them to join the Naxalite movement. But the extremist activities have been threat to law and order and peaceful living of the people residing in the affected areas.

(f) **Social Disparity.** Social disparity among the people of different communities, castes and sometime within the community and caste causes tension and imbalance among the people. Social disparity poses great threat to national integration.

Opportunities

11. The following opportunities must be exploited at all times to ensure National Integration:-

(a) **Defence Forces & Central Police / Other Organisations.** These organisations provide us with a an opportunity to maintain National Integrity at all times since, these are all India based organisations and consist of personal from the whole country, working, eating, living and fighting together for the integrity of the country.

(b) **National Level Games.** Games like the Olympics, Asiad, Commonwealth etc, provide an excellent opportunity to forment National Integration since players / athletes form all over the country participate as 'one team' – forgetting their regional / other differences / considerations.

(c) **NCC.** NCC is an excellent organisation which propagates and maintains National Integration in all aspects of training the youth through National Integration Camps, Adventure Camps and the RDC.

CONCLUSION

12. India is a land of the great diversities and infinite varieties. It is a country with at least 18 major languages and over 400 important dialects. It is a land that has given rise to four of the world's major religions. It is home to the world's second largest Muslim population. It is a society with over 4,000 ethnic communities or castes or endogamous groups. India is thus a multi-religious, multi-linguistic, multi-ethnic and multi-regional civilization without a parallel. Therefore, in order for our nation to succeed and prosper, national integration is an important tool that this nation needs to embark on.

LESSON PLAN : NI 5
PROBLEMS / CHALLENGES OF NATIONAL INTEGRATION

Period	-	One
Type	-	Lecture
Code	-	NI 5
Term	-	II (SD/SW)

Training Aids

1. Computer, Projector, Charts, Pointer, Black Board & Chalk.

Time Plan

2.	(a)	Introduction	-	05 Min
	(b)	Major Problems / Challenges	-	15 Min
	(e)	Suggested Measures	-	15 Min
	(d)	Conclusion	-	05 Min

INTRODUCTION

3. India is a country with innumerable diversities, an entity composed of many communities, races classes, languages and sub cultures. In any such nation, there are many obstacles to the achievement of national integration. In India, various hindrances are obstructing the growth of national feeling, viz. casteism, communalism, linguistic fanaticism, social disparity, economic inequalities and immorality, regionalism etc. India is a land of various races; various religious and various languages. Still then, the Indians developed into one nation by the influence of common territory, common history and common fight for freedom against the foreign rule.

4. When India came under the British, they followed the policy of 'Divide and Rule' in order to perpetuate their authority over India. Consequently, the racial, the religious and the linguistic groups in the Indian nation first began to disintegrate emotionally and psychologically and then, desired to disintegrate territorially. This resulted into division of India into Bharat and Pakistan. Today, the integrity of the Indian nation is awfully threatened as the communal quarrels are fanned by the hostile neighbours of India. Hence, the necessity of strong national Integration in India has become so necessary at present.

AIM

5. To acquaint the cadets about the Problems / Challenges of National Integration in India.

PREVIEW

6. The lecture will be conducted in following parts:-
 - (a) Part I - Major Problems / Challenges of National Integration.
 - (b) Part II - Measures to Achieve National Integration.

PART I : PROBLEMS / CHALLENGES OF NATIONAL INTEGRATION

7. **Casteism.** Caste is an imported part of our social fabric. This was developed in the past on the basis of division of labour in the society. But now casteism has segregated the society. Unity and integrity has become a dream in a caste ridden society. The feeling of socially neglected scheduled castes under the suppression of upper caste ruined the sense of feeling and unity. It becomes a problem for national integration.

8. **Communalism.** Religions antagonism has posed a serious challenge to national integration in India. India is a multi- religious land. Political manipulation has projected one religion against the other which resulted in communal riot, bloodbath, mutual, distrust and disintegration of the country. Large scale illiteracy and superstition are responsible along with other causes for raise communalism in the country. It is very difficult to promote national integration under these situations.

9. **Linguistic Fanaticism.** Multi-linguism is one of the important characters of India. India has fifteen officially recognized languages. There are about 1652 languages which are spoken in India which shows its diversities. There is conflict and riots on the languages issue. People of one language try to establish their language over others. When Hindi was declared as the national language people of South India resented against this decision supporting English language. Language issue became a barrier on the way of national integration.

10. **Regionalism.** There are several regions in India having their unique traditions, food habits, dress and languages. Each regional differs from the other in one or other ways which leads to disintegration of the country. People of one region compete with the person of other regions which leads to conflict and riots. Land dispute, language problem are some of the reasons which pose hurdle on the way of national integration.

11. **Social Disparity.** Social disparity among the people of different communities, castes and sometime within the community and caste causes tension and imbalance among the people. Social disparity poses great challenge to national integration.

12. **Economic Inequalities.** Economic standard of people in a state depends on the fertility of land, resources available and manpower management. All the states are not equal in the above matter which leads to economic backwardness of the people. Even in a state distribution of wealth is not properly done. Day by day poor becoming poorer and rich become richest this causes tension and conflict. It is a problem for national integration

PART II : MEASURES TO ACHIEVE NATIONAL INTEGRATION

13. **Education.** Education of the masses can become a very powerful instrument of national unity provided that it is used in the right manner.

14. **Religious Tolerance.** India is a multi religious country with various religious communities, such as Hindus, Muslims, Sikhs, Christians, Buddhists, Jains and Parsies. Each community should appreciate the coexistence of every other community, should promote love and communal harmony in society by celebrating / observing important days of every other community. Each community should help and share the religious festivals of every other community.

15. **Linguistic Tolerance.** India, is a multi-lingual country with linguistic groups speaking different languages, such as Hindi, Urdu, Bangali, Oriya, Assamee, Marathi, Gujarati, Punjabi and so on. Each linguistic group should respect the language of every other linguistic group. Every Indian student should be given full facility to learn his own language wherever he is in India. The work must be begun at the grass-root levels, for this, a band of honest and popular teachers must work. From the impressionable age, boys and girls, must be taught and encouraged to mix with each other.

16. **Use of Radio / TV.** The services of the Radio and TV must be intelligently used. People of different states must be introduced to each other's cultures and ways of life and common elements should be stressed upon. But these will only create an atmosphere of goodwill and mutual understanding. Other steps are necessary.

17. **Government Initiative.** At government level, it should be obligatory for members of the All India Services to learn at least one language of a state other than that to which they may belong. On the same principle an All India Educational Service should be organized so that teachers of one State may serve in another at the popular level, political parties or organizations with a communal or racial bias should be ruthlessly banned. Finally, all healthy cultural movements to foster a national, all-India outlook should have to be encouraged.

CONCLUSION

18. We need national integration on permanent footing and this can be achieved by enlightening our children. All the children, during their formative years, must be taught that we all are Indians belonging to the one Motherland. We must not believe in separate identities. It is the time to merge in one main stream. Unless we develop a sense of unity and leave our narrow outlook, we might lose our independence.

LESSON PLAN : NI 6
UNITY IN DIVERSITY

Period	-	One
Type	-	Lecture
Code	-	NI 6
Term	-	II (SD/SW)

Training Aids

1. Computer, Projector, Charts, Pointer, Black Board & Chalk.

Time Plan

2.	(a)	Introduction	-	05 Min
	(b)	Importance and Fundamentals of National Unity	-	15 Min
	(c)	Relevance of NCC in Unifying India	-	15 Min
	(d)	Conclusion	-	05 Min

INTRODUCTION

3. India is a vast country with diversity in caste, religion, customs and traditions where people from different ethnological groups having different languages or dialects, follow different rituals in daily life and work together shoulder to shoulder. In spite of diversity in physical features and social systems, there is unity in India. It is held together by many ties like territory, language, culture, traditions, economic growth and inter-dependence

AIM

4. To acquaint the cadets about Unity in Diversity.

PREVIEW

5. The lecture will be conducted in following parts:-
 - (a) Part I - Importance and Fundamentals of National Unity.
 - (b) Part II - Relevance of NCC in Unifying India.

PART I : IMPORTANCE AND FUNDAMENTALS OF NATIONAL UNITY

Importance of National Unity

6. National unity is extremely essential for social peace and harmony. We can enjoy peace and security, if there is a mutual trust and goodwill among all the sects of people of the country. No progress can be made by the nation in any field if disruptive tendencies and divisive forces keep on destroying the very fabric of national unity.

Fundamentals of Unity

7. Some of the essentials for National Unity are as given below:-

(a) **Language**. Narrow minded love towards one's own language and negative feeling towards others is a major hindrance to unity. No country can stand on the pillars of an alien language. A language, instead of dividing, should be a unifying force. A via media acceptable to all would go a long way in bringing about linguistic unity in the country. Along with regional languages one national language should be fully developed. Languages of different states should be encouraged in the educational institutions.

(b) **Casteism**. It is felt in offices and colleges, in politics and almost in all walks of life. The feeling of belonging to an upper caste and hatred for the lower caste is not only an offence against mankind it is a threat to India's unity. The system of casteism and untouchability would eat into the very vitals of a society. Casteism should be tackled with an iron hand. There should be no communal or special constituents. The minority communities should be given their due share of advancement and communal favouritism should be sternly dealt with.

(c) **Education**. In India about half of the total population is illiterate. An illiterate person cannot understand what is good or bad for himself or his country. Literacy is an important ingredient for unity. The pattern of education should be so oriented that it encourages love, brotherhood and unity amongst various communities. There could be exchange of teachers from one state to another and there should be no bar on the students of one state for admission into the universities of other states. It would help to cement the bonds of unity which is an essence of any nation.

(d) **Communalism**. Communalism means discriminatory feelings of an individual against another on the basis of religion or caste. This also endangers the unity of our country. Fundamentalism is the greatest challenge to India's unity. This has to be sternly dealt with. The politicians who encourage provincialism and regionalism should be debarred from elections as members of legislative bodies. All citizens should regard themselves as Indians first and build unity between different sections of our society.

(e) **Regionalism**. India is a vast country where regional diversities exist. The feeling of loyalty towards one's own state or region first is also a major hindrance in unity. People from different parts of the diversified subcontinent should meet under a common wing of national consciousness, forgetting the regional differences, sharing the feelings of togetherness and realise the proud feeling in themselves of being part and parcel of a common Indian diaspora.

PART II : RELEVANCE OF NCC IN UNIFYING INDIA

8. NCC creates awareness amongst youth about the diverse heritage of our country and fosters national integration despite linguistic, cultural, religious and geographical barriers. It helps cadets gain experience to live together, co-operate with each other and work in harmony with cadets of other states whom they have not known before, thus helping in strengthening unity as under:-

(a) **Ethics and Social Values**. These are very important values in day-to-day activities on the ground and are the essentials of personality. NCC helps to cultivate these values through which the spirit of unity and value of personal sacrifice are ignited in the minds of cadets.

(b) **Cultural and Traditional Values**. Our country has diverse groups which have been divided on grounds of religion, caste, creed and language. NCC organises various camps and group activities where ample opportunity is given to the cadets to closely watch the cultural and traditional shows of other regions. It provides the cadets with an opportunity to appreciate each other's uniqueness and cultivate friendship.

(c) **Discipline and Patriotism**. A cadet is trained to give selfless service to society and be available anytime for national cause. NCC can be described as the nation's

disciplined, trained and motivated young force available for national service to provide assistance in various places as well as provide future leadership and participation in all walks of life.

CONCLUSION

9. It is the duty of each and every citizen of our country to strive to achieve total unity despite of diversity in culture, language and religion. We must remember that there should be no divisions between any religion or community. There is only one India of which, we all Indians are inheritors. We are therefore - Indian first and Indians last.

LESSON PLAN : NI 7
NATIONAL INTEGRATION COUNCIL

Period	-	One
Type	-	Lecture
Code	-	NI 7
Term	-	III (SD/SW)

Training Aids

1. Computer, Projector, Charts, Pointer, Black Board & Chalk.

Time Plan

2.	(a)	Introduction	-	05 Min
	(b)	Organisation & Composition of NIC	-	10 Min
	(c)	Role and Functions of NIC	-	20 Min
	(d)	Conclusion	-	05 Min

INTRODUCTION

3. National integration is essential for any nation with socio-cultural, religious, linguistic and geographical diversities. A unique feature of our country is that all the major religions of the world are practiced here such as Hinduism, Islam, Christianity, Buddhism, Sikhism, Jainism, and Zoroastrianism. There are more than one thousand languages that people of India speak. There are also great varieties in costume, food habits, and social customs. Geographically, our land is diverse and there are amazing differences in climate. Despite all these differences India is one political entity. We have to co-exist with each other peacefully, respect the culture and religion of our fellow Indians. This is possible only when national integration is realised in true sense of the term. National integration is necessary also for the security and development of the nation.

4. The National Integration Council (NIC) originated in a conference convened by the then Prime Minister Jawaharlal Nehru in September-October of 1961. The purpose was to find ways to address the problems of communalism, casteism and regionalism. The conference set up the NIC to review national integration issues and make recommendations. The NIC met for the first time in June 1962. The NIC was reconstituted and met again in August 2005. The new council had 103 members including twelve Chief Ministers, twelve Union Ministers and leaders of all the main political parties.

AIM

5. To acquaint the cadets about the National Integration Council of India.

PREVIEW

6. The lecture will be conducted in following parts:-
 - (a) Part I - Organisation & Composition.
 - (b) Part II - Role and Functions.

PART I : ORGANISATION & COMPOSITION OF NIC

7. In April 2010, the NIC was again reconstituted with 147 members. These included the following:-

- | | | |
|--------|---|------|
| (a) | Chairman - Prime Minister | |
| (b) | <u>Members.</u> | |
| (i) | Union Ministers | - 14 |
| (iii) | Chief Ministers (States / UTs) | - 30 |
| (iii) | Leaders of Political / Regional Parties | - 13 |
| (iv) | National Commissions | - 05 |
| (v) | Media Persons | - 19 |
| (vi) | Representatives of Business | - 10 |
| (vii) | Representatives of Labours | - 02 |
| (viii) | Women Representatives | - 08 |
| (ix) | Eminent Public Representatives | - 45 |

8. **Standing Committee.** On 19 October 2010, the government established a Standing Committee of the National Integration Council under the chairmanship of the Home Minister, with four Union Ministers and nine Chief Ministers as members. The committee would decide on agenda items for future council meetings.

PART II : ROLE AND FUNCTIONS OF NIC

9. The Supreme Court had commended the role of the National Integration Council, set up by Prime Minister Jawaharlal Nehru ie, "To find ways to counter problems that are dividing the country including attachment to specific communities, castes, regions and languages". Other steps that have long been kept pending are:-

- (a) Stern action against 'hate crimes'. Hate campaigns are the incubators of communal violence.
- (b) Enacting of the Communal Violence Bill and ensuring that it takes care of the concerns of the Christian community and does not further arm communal administrations or further emboldens impunity of communalised police elements.
- (c) Comprehensive relief and rehabilitation policies that wipe the tear from the eyes of victims of communal violence and give them the opportunity of creating a new life.
- (d) Adequate representation to all minorities and underprivileged groups in the police, administrative and judicial systems.
- (e) A thorough revamp of the education system, including a close watch on the recent rash of communally motivated village and rural schools set up by political groups, so that once again secularism, religious and cultural diversity and pluralism become the cornerstone of our nation-building.

(f) Above all, the State - Parliament, Supreme Court, and Executive - must ensure that no one remains under the illusion, unfortunately very well founded at present that communal politics, hate and the demonization of religious minorities can bring them electoral dividends in an India of the Twenty-first Century.

(g) To make provisions under Fundamental Duties to reinforce national integration. The following are important:-

(i) To abide by the Constitution and respect its ideals and institutions, the National Flag and the National Anthem.

(ii) To cherish and follow the noble ideals which inspired our national struggle for freedom.

(iii) To defend the country and render national service when called upon to do so.

(iv) To promote harmony and the spirit of common brotherhood amongst all the people of India and respect religious, linguistic and regional or sectional diversities.

(v) To renounce practices derogatory to the dignity of women.

(vi) To value and preserve the rich heritage of our culture.

(vii) To safeguard public property and to reject violence.

(viii) To strive towards excellence in all spheres of individual and collective activity so that the nation constantly rises to higher levels of achievement.

10. **Agenda Points of 15th NIC Meeting**. The 15th NIC meeting was held on 10 Sep 2011, where in, some of the important agenda points emphasized and discussed by the Honorable Prime Minister are under:-

(a) Continuously and creatively work towards securing in greater measure, the socio-economic and other aspirations of all sections of society.

(b) Emphasizing on a focused approach to end the pervasive feeling of alienation and discrimination among minorities and marginalised sections of society, particularly the scheduled tribes, scheduled castes and women.

(c) Promoting greater inclusiveness and social equity and ensuring that the law enforcement and investigation machinery does not carry any bias, while discharging its duties.

(d) Engaging the energy and initiative of our youths for constructive purposes.

(e) Providing opportunities to our youths to acquire skills, engage in nation-building and social work, and interact more actively in sports, cultural and other character-building pursuits. These need to be enhanced and encouraged.

(f) Creation of new opportunities for productive employment for our growing labour force and emphasized provision of education and health care facilities on an adequate scale assume great importance.

CONCLUSION

11. National integration assumes greater importance particularly in a country like India where, people with different language religions races and culture are required to be weaved together. The 'unity in diversity' of which we are proud of can only be maintained if we have the understanding and respect for each other's religions, customs and traditions. It is said that "united we stand and divided we fall". If we have to survive as a nation and safeguard our sovereignty and national integrity, we have to remain united.

LESSON PLAN : NI 8
IMAGES / SLOGANS FOR NATIONAL INTEGRATION

Period	-	One
Type	-	Lecture
Code	-	NI 8
Term	-	III (SD/SW)

Training Aids

1. Computer, Projector, Charts, Pointer, Black Board & Chalk.

Time Plan

2.	(a)	Introduction	-	05 Min
	(b)	Images of National Integration	-	15 Min
	(c)	Slogans of National Integration	-	15 Min
	(d)	Conclusion	-	05 Min

INTRODUCTION

3. A Nation is a community which considers itself one. It is held together by many ties just like territory, language, culture, economic inter dependence etc. Thus a Nation is a large group of people, sharing the same culture, language or history and inhabiting a particular state or area. India is a Nation sharing different culture, religion and history under one sovereign state. Indian civilization is one of the oldest civilizations in the world. In the past people belonging to different races and religions came & settled here. They brought with them their distinctive language and life style. Different tribes with their distinct languages intermingle with various tribes of our country. That is why our culture is described as an example of composite culture. It is made up of all communities, races and religions.

AIM

4. To acquaint the cadets about National Integration through various Images / Slogans.

PREVIEW

5. The lecture will be conducted in following parts:-
 - (a) Part I - Images of National Integration.
 - (b) Part II - Slogans of National Integration.

PART I : IMAGES OF NATIONAL INTEGRATION

6. **General.** Images and posters have a very lasting and defining effect / impression on a persons mind and keeps reminding him of what he has seen. This has a very positive effect on his thinking and actions. Images / posters also have are very major impact on impressionable minds of children and adolescents. That is the reason of putting up huge hoardings you see on the roads and in towns / cities. It is one of the most effective method's of conveying a social message.

7. Some of the important images related to National Integration are as under:-

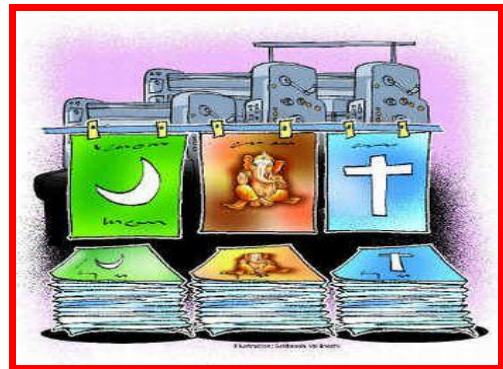
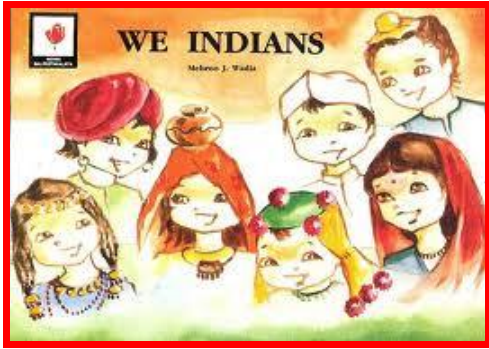

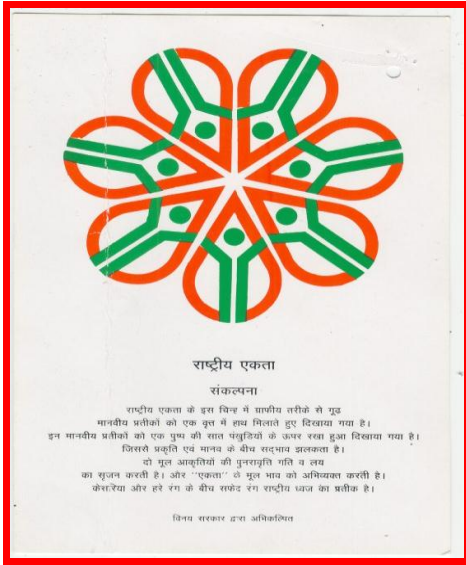

PART II : SLOGANS OF NATIONAL INTEGRATION

8. Just like images / posters, slogans also have a positive and lasting impression on the minds. Some of the important slogans related to National Integration are as under:-

India: Unity in Diversity



- ✦ It has 28 states and 7 union territories
- ✦ There are 18 official languages, 114 languages, 216 mother tongues and 900 dialects in India.
- ✦ Hindi: National language. English: commonly used for national, political, commercial & educational purposes
- ✦ 7th largest country, 2nd most populous (1.08 billion).
- ✦ 1 out of 5 people in the world = Indian

India: Unity in Diversity



India is a picture of diversity seen in her people, cultures, colorful festivals, dresses and costumes, religions, flora and fauna and varying landscapes.



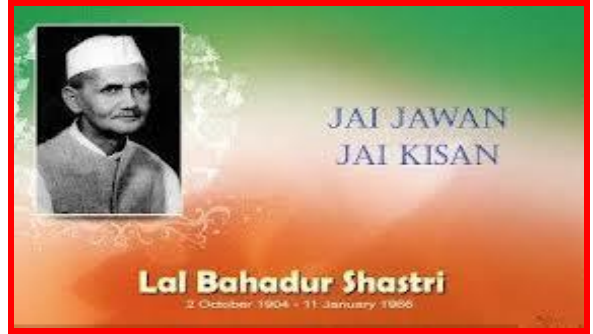

CONCLUSION

9. Images, posters and slogans have a lasting impression on the minds of people. Hence it is an important tool for promoting National Integration in India. The NCC Logo is itself an excellent example of National Integration and is true to its image.

LESSON PLAN : NI 9
CONTRIBUTION OF YOUTH IN NATION BUILDING

Period	-	One
Type	-	Lecture
Code	-	NI 9
Term	-	III (SD/SW)

Training Aids

1. Computer, Projector, Charts, Pointer, Black Board & Chalk.

Time Plan

2.	(a)	Introduction	-	05 Min
	(b)	Contribution of Youth in Nation Building	-	30 Min
	(c)	Conclusion	-	05 Min

INTRODUCTION

3. The youth of a nation are the backbone and the most powerful force within the nation. They are the hope of the future and can shape the destiny of a country. History shows that countries subjected to alien rule have without exception sought the help of youth in times of crisis. The youth have also been instrumental in the change of governments, whenever need for such a change has been felt. They have always been in the forefront in the building of political, social and economic orders of a society. They play a positive role for the cause of a nation and national integration. Today's generation faces greater challenges in national building due to the force and pressure of internal politics and external conflicts.

AIM

4. To acquaint the cadets about the Contribution of Youth in Nation Building.

CONTRIBUTION OF YOUTH IN NATION BUILDING

National Integration

5. The youth act as a catalyst in an already vibrant country aspiring to find its rightful place in the world politics and play a more effective role of a true leader. To help India realise its dreams the youth can and ought to play a leading role in bringing together the people of different states with diverse religions and integrate them emotionally, culturally and geographically, contribute in extricating society from age old stigmas of casteism, communalism, parochialism and regionalism, help preserve cultural heritage and infuse the spirit of patriotism, thus keep the country together and defeat all separatist attempts by unscrupulous elements.

Political Measures

6. Today's youth can contribute immensely to the politics of the country. If a nation does not rejuvenate its political leadership profile it would become old in thought and slow in action. The youth are the future of a nation and its future leaders. The opportunity provided at educational

level to contribute to politics should be encouraged and the youth should learn and follow clean and meaningful politics which can thereafter be translated into greater national aim.

Security

7. The nation today faces grave security concerns both externally and internally. This intensifies when viewed with the fact that our country is a respected democratic country with a secular base. The terrorist, fundamentalists are a grave danger to our unity. The youth are the pulse and strength of the nation and with their alertness and their balanced approach can help in bringing stability to the nation and help in thwarting selfish designs of the enemy. The youth are a big force which if channelized correctly, can ensure and enhance the security of the country.

Social and Cultural

8. The youth are the privileged persons in the society who can contribute to development. Therefore they have a special responsibility and should actively participate in the development plans of the nation. Youth should be acquainted with the major problems facing the country. Firstly, they should study the basic problem of health, AIDS, environment, nutrition, lack of education, economic backwardness, ignorance, dowry-deaths, casteism, and superstitions /false beliefs of the masses. Our society is experiencing a constant change and faces the conflicting ideologies of the past vis-a-vis the West. Our past with a shadow of casteism, superstition and religious over tunes needs a balanced approach and the youth can play a very important role in this regard and educate the general public about the misnomers relating to superstition. The need to do away with the caste system and encourage lateral, vertical and diagonal in mingling of people to mesh them into a true Indian network. They can establish good rapport with the people so as to involve them in active participation in social work which will help to make society a better place to live in.

9. Further, the Government programmes such as 'Clean and Green' are very good opportunities for youth to join hands with their countrymen and give impetus in the process of nation building.

10. India has a National Cadet Corps (NCC), National Social Service (NSS), National Service Volunteer Scheme (NSVS) and other similar organization, which are an asset to our Nation. Apart from these measures to channelise young energy into constructive channels, following few steps can be taken.

(a) Films with social upliftment and nation building as theme would make a fair contribution in instilling a healthy and progressive attitude in the youth. Non Government Organisation (NGO) should also engage youth in such programmes which strengthen nation building.

(b) There should be integration committees, composed of representatives of various communities at village, city, district, state and national level. Youth should be engaged in such committees to contribute in society. Youth to train themselves effectively both in institutional and adventure activities, as such activities imbibe self confidence, harmony and patriotism.

CONCLUSION

11. Young men and women are the reservoirs of unbounded energy and enthusiasm. Youth should accept all the challenges faced by the country. Let the youth be put to best use. For this, their energies, skills and talents have to be properly harnessed, channelised and put to right use for the common good of the country.

INDEX**DRILL**

<u>Ser No</u>	<u>Lesson Code</u>	<u>Subject</u>	<u>Cat</u>	<u>Page No</u>
<u>FOOT DRILL</u>				
1.	FD 1	Drill Ki Aam Hidayaten Aur Words of Command	SD/SW	50
2.	FD 2	Savdhan, Vishram, Aram Se Aur Mudna	SD/SW	53
3.	FD 3	Kadwar Sizing, Teen Line Banana, Khuli Line Aur Nikat Line Men March	SD/SW	56
4.	FD 4	Khade Khade Salute Karna, Parade Par, Visarjan aur Line Tod	SD/SW	59
5.	FD 5	Tej Chal - Tham Aur Dhire Chal - Tham	SD/SW	62
6.	FD 6	Dahine, Baen, Age aur Piche Kadam Lena	SD/SW	64
7.	FD 7	Tej Chal Se Mudna	SD/SW	67
8.	FD 8	Tej Chal Se Salute Karna	SD/SW	70
9.	FD 9	Tej Kadam Taal Aur Tham	SD/SW	73
10.	FD 10	Tej Kadam Taal Se Kadam Badalna	SD/SW	74
11.	FD 11	Teenon Teen Se Ek File Aur Ek File Se Teenon Teen Banana	SD/SW	75
<u>ARMS DRILL</u>				
12.	AD 1	Rifle Ke Sath Savdhan, Vishram Aur Aram Se	SD/SW	76
13.	AD 2	Rifle Ke Sath Parade Par Aur Saj	SD/SW	78
14.	AD 3	Rifle Ke Sath Visarjan Aur Line Tod	SD/SW	79
15.	AD 4	Bhumi Shastra Aur Uthao Shastra	SD/SW	80
16.	AD 5	Bagal Shastra Aur Baju Shastra	SD/SW	82
17.	AD 6	Salami Shastra	SD/SW	84
18.	AD 7	Squad Drill	SD/SW	86
19.	AD 8	Nirikshan Ke Liye Janch Shastra Aur Baju Shastra	SD/SW	87
<u>CEREMONIAL DRILL</u>				
20.	CD 1	Guard Mounting	SD/SW	89
21.	CD 2	Guard Of Honour	SD/SW	92
22.	CD 3	PI / Coy Drill	SD/SW	95
23.	CD 4	Instructional Practice	SD/SW	96

LESSON PLAN : FD 1
DRILL KI GENRAL HIDAYATEN AUR WORDS OF COMMAND

Period	-	One
Type	-	Lecture and Practice
Code	-	FD 1
Term	-	I (SD/SW)

Training Aids

1. Drum and drummer, Pace and stick, Angle board, Back stick, Ghadi (samay suchak).

Time Plan

2. (a) Drill Ki General Hidayten - 20 Min
- (b) Words of Command - 20 min

BHUMIKA

3. Shuru shuru mein fauj ke andar, drill ki sikhlai Germany ke Major General Dral ne 1666 mein shuru kiya tha, is uddesh ko samne rakhte hue ki, faujon ko control karne ke liye drill hi ek aisa zariya hai, jisse discipline, turnout aur team spirit ki bhavna lai ja sakti hai. Yeh pichli ladaion se sabit ho chuka hai ki, ladai ke maidan mein discipline ki buniyad rakhne mein, drill ne kafee sahyog diya hai.

TARTIB

- 4 Is lesson ko do bhagon mein chalaya jayega.
 - (a) Bhag I - Drill ke General Hidayaten.
 - (b) Bhag II - Words of Command.

BHAG I : DRILL KI GENRAL HIDAYATEN

5. **Drill Ki Paribhasha.** Kisi procedure ko kramwar aur uचित tarike se karne ki karyawahi ko 'drill' kahte hain.
6. **Drill ke Prakar.** Drill do prakar ki hoti hai:-
 - (a) **Open Drill.** Open drill field mein kiya jata hai.
 - (b) **Close Drill.** Close drill peace mein rahte hue, parade ground men ki jata hai.
7. **Drill Ka Maksad.** Drill ke nimnlkhit maksad hote hain:-
 - (a) Drill discipline ki buniyad hai.
 - (b) Drill se milkar kaam karne ki aur hukm manne ki aadat parti hai.
 - (c) Drill officers, JCOs aur NCOs ko command aur control sikhati hai.

- (d) Drill dress pahanna aur chalna phirna sikhati hai.
- (e) Drill ko dekh kar kisi unit ke discipline aur morale ka pata lagaya ja sakta hai.
8. **Drill Ke Usul.** Drill ke teen usul hain:-
- (a) Smartness (furti).
- (b) Steadiness (sthirta).
- (c) Coordination (milkar kaam karna).
9. **Foot Drill Ke Usul.** Shoot the foot forward (paon ko teji se age nikalna).
10. **Drill Mein Buri Aadten.** Drill mein buri adaten is prakar se hain:-
- (a) Aankh ka ghumana (rolling of eyes).
- (b) Koodna aur fudakna (hopping and jumping).
- (c) Paon ko ghasit kar chalna (dragging of foot).
- (d) Arion ko takrana (clicking the heel).
- (e) Boot mein angulion ko harkat dena.

BHAG II : WORDS OF COMMAND

11. Ek sahi word of command nirbhar karta hai awaz ki "tone aur pitch" pe. Durust word of command "clear aur unchi awaz " men diya jata hai, taki uska turant amal kiya jaye. Ek ache word of command dene ke liye nimnlikhit baten zaruri hain:-

- (a) **Loudnes (Swar).** Word of command ki loudness is baat pe nirbhar karta hai ki word of command kitne logon ko diya ja rah hai ya unki duri kitni hai. Word of command dene ke liye, commander apne aap ko squad ki samne, bichon bich unki taraf muh kar ke khada ho kar diya jata hai. Word of command hamesha – savdhan position men diya jata hai.
- (b) **Clarity (Safai).** Jeeb, lips aur danton ka sahi talmel ke sath clear word of command diya jae. Sust word of command squad men tezi nahi paida karega.
- (c) **Pitch.** Durust word of command ke liye sahi pitch ka hona zaruri hai.
- (d) **Timing.** Word of command ki sahi timing uske turant amal ke liye bahut hi zaruri hai. Ek word of command ke do bhag hoten hai "cautionary" aur "executive". Cautionary aur executive ke bich char (four) tez kadam ka fasla hona chahiye. Tez chal men, cautionary word of command, baen pair se shuru hota hai.

12. **Words of Command.** Drill men nimlikhit words of command diye jaten hain (Byan ke sath Namuna):-

- (a) Savdhan aur Vishram.
- (b) Dahine Mud ya Baen Mud.
- (c) Piche Mud ya Age Mud.

- (d) Dahine Dekh ya Baen Dekh.
- (e) Tez Chal ya Dhire Chal aur Tham.
- (f) Khuli Line Chal ya Nikat Line Chal.
- (g) Line Ban, Sajja ya Visarjan.
- (h) Dahine Salute, Baen Salute ya Samne Salute.

13. **Abhyas.** Ustad words of command ka ek ek kar ke abhyas karaye.

LESSON PLAN : FD 2
SAVDHAN, VISHRAM, ARAM SE AUR MUDNA

Period	-	One
Type	-	Lecture and Practice
Code	-	FD 2
Term	-	I (SD/SW)

Training Aids

1. Nil.

Time Plan

- | | | | | |
|----|-----|---------------------------|---|--------|
| 2. | (a) | Savdhan, Vishram, Aram Se | - | 15 Min |
| | (b) | Khade Khade Mudna | - | 15 Min |

UDDESH

3. Is period mein khaali haath drill men Savdhan, Vishram, Aram Se aur Khade Khade Mudna ki karyawahi sihkana hai.

TARTIB

4. Yeh Sabak do bhagon mein chalaya jayega:-
- | | | | |
|-----|---------|---|--|
| (a) | Bhag I | - | Savdhan, Vishram, Aram Se – Bayan va Namuna. |
| (b) | Bhag II | - | Khade Khade Mudna – Bayan va Namuna. |

BHAG I : SAVDHAN, VISHRAM AUR ARAM SE

Savdhan

5. **Zarurat.** Jab drill ki koi bhi harkat karni ho toh hamesha savdhan position se hi shuru hoti hai. Iske alawa, apne se senior ke saath baat karni ho to, savdhan position se hi baat ki jaati hai.
6. **Bayan se Namuna.** Jab word of command milta hai “Savdhan” to baen paon ko 6 inch uthate hue dahine paon ki aeedi ke saath baen paon ki aeedi milaen. Jab baen paon zamin par lagta hai to shout karen ek. Savdhan position mein dekhne ki baten.
- | | |
|-----|--|
| (a) | Dono aedian mili hui aur toe ka angle 30 degree. |
| (b) | Dono ghutne kase hue hon. |
| (c) | Dono baju dahine aur baen taraf pant ki silai ke saath mile hue aur mutthi kudrati taur par bandh ho. |
| (d) | Pent kheencha hua, chhati uthi hui, kandhe piche kheenche hue, gardan collar ke saath mili hui, chin upar aur nigah samne. |

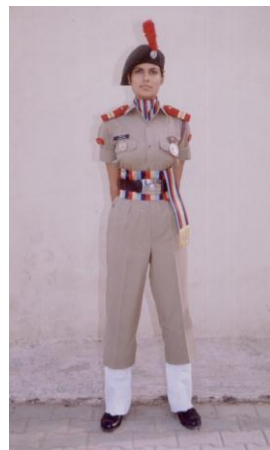
**Savdhan Position****Vishram Position****Vishram Aur Aram Se**

7. **Zarurat.** Jab senior ke saath baat khatam kar lete hain to, Vishram ki karyawahi ki jaati hai ya drill ki harkat khatam hone par Vishram aur Aram se ki karyawahi karte hain.
8. **Bayan se Namuna.** Jab Savdhan position se word of command milta hai 'Vishram' to baen paon ko 6 inch upar uthate hue, 12 inch door lejate hue zamin par rakhen aur, saath hi, dono bajuon ko piche le jaen, bayen haath niche aur dahina haath upar se pakden aur shouting karen ek. Is position mein dekhne ki baten:-
- Dono aadedion ke beech 12 inch ka fasla.
 - Dono ghutne kase hue.
 - Dono haath piche bandhe, Bayen haath niche aur dahina haath upar se , angulian niche ki taraf , dahina angutha baen anguthe ke upar se.
 - Badan ka bojh dono paon par.
9. 'Aram se' ke word of command par, kamar ke upar wale hisse ko dheela Karen lekin, paon se harket nahin hogi.
10. **Abhyas.** Ustad pure squad ka ginti se 'word of command' pe durust abhyas karaen.

BHAG II : KHADE KHADE MUDNA**Dahine Mudna**

11. **Zarurat.** Jab hum ek jagah par khade hon aur 90 degree par dahine taraf apni simmat aur formation ki badli karni ho to "Dahine Mud" ki karyawahi ki jati hai.
12. **Ginti aur Bayan se Namuna.**
- Jab savdhan position se word of command milta hai ginti se mudna 'dahine mud ek' to is word of command par dahine paon ki aeedi aur baen paon ke panje par dahine taraf 90 degree teji se ghoom jayen aur shout karen 'ek'. Is position mein dekhne ki baten - dahina paon pura zamin par laga hua aur, badan ka bojh dahine paon par, baen paon ka panja zamin par aur aedi uthi hui, dono tangen kasi hui hon.

(b) Jab word of command milta hai 'do' to is word of command par baen paon ko 6 inch upar uthate hue dahine paon ke sath savdhan position mein lagaen aur shout karen 'do'. Is position mein dekhne ki baten - Dahine taraf 90 degree par simmat ko badli ki hue ho.

13. **Abhyas.** Ustad pure squad ka ginti se 'word of command' pe durust abhyas karaen.

Baen Mudna

14. **Zarurat.** Jab ham ek jagah par khade hon aur 90 degree par baen taraf apni simmat aur formation ki badli karni ho to "baen mud" ki karyawahi ki jaati hai.

15. **Ginti aur Bayan se Namuna.**

(a) Jab Savdhan position se word of command milta hai 'ginti se mudna baen mud ek' to is word of command par baen paon ki aaedi aur baen paon ke panje ki madad se 90 degree, teji se ghoom jayen aur shouting karen 'ek'. Is position mein dekhne ki baten - badan ka bojh baen paon par aur bane paon pura zamin par laga hua ho, dahine paon ka panja zamin par aur aaedi uthi hui ho, dono tangen kasi hui.

(b) Jab word of command milta hai 'do', to dahine paon ko 6 inch upar uthate hue baen paon ke sath savdhan position mein lagaen aur shouting karen 'do'. Is position mein dekhne ki baten - baen taraf 90 degree par simmat ko badli kiye hue ho.

16. **Abhyas.** Ustad pure squad ka ginti se 'word of command' pe durust abhyas karaen.

Pichhe Mudna

17. **Zarurat.** Jab ham ek jagah par khade hon aur, 180 degree par piche ki taraf apni formation ko kayam rakhte hue simmat ko badli Karen to, "pichhe mud" ki karyawahi ki jaati hai.

18. **Ginti aur Bayan se Namuna.**

(a) Jab Savdhan position se word of command milta hai 'ginti se mudna pichhe mud ek' to is word of command par dahine paon ki aaedi aur baen paon ke panje par 180 degree par teji se ghoom jayen aur shouting karen 'ek'. Is position mein dekhne ki baten - dahina paon pura zamin par laga hua, badan ka bojh dahine paon par, baen paon ka panja zamin par aur aaedi uthi hui. Dono tangen kasi hui aur thai muscle apas men mile hue.

(b) Jab word of command milta hai 'do' to baen paon ko 6 inch upar uthate hue dahine paon ke saath savdhan position mein lagaen aur shouting karen 'do'. Is position mein dekhne ki bat - 180 degree par simmat ko badli ki hui ho aur baki position savdhan.

19. **Abhyas.** Ustad pure squad ka ginti se 'word of command' pe durust abhyas karaen.

Aadha Dahine Aur Baen Mudna

20. **Zarurat.** Jab khade khade squad se salute ka abhyas karwana ho ya iske alawa dahine/baen squad banana ho ya disha badal ki karyawahi karna ho toh adha dahine / baen mud ki karyawahi ki jati hai.

21. **Ginti aur Bayan se Namuna.** Ginti aur bayan se namuna usi tarah hai jaise aap dahine / baen mud ka namuna dekh chuke hain, sirf itna fark hai ki adha dahine / baen mudne mein 90 degree ke bajay 45 degree par dahine/ baen ko simmat ki badli Karen.

22. **Abhyas.** Ustad pure squad ka, ginti se, 'word of command' pe durust abhyas karaen.

LESSON PLAN : FD 3
KADWAR SIZING, TEEN LINE BANANA,
KHULI LINE AUR NIKAT LINE MEN MARCH

Period	-	One
Type	-	Lecture and Practice
Code	-	FD 3
Term	-	I (SD/SW)

Time Plan

1.	(a)	Kadwar Sizing	-	15 Min
	(b)	Teen line Banana	-	10 Min
	(c)	Khuli Line aur Nikat Line men March	-	15 Min

UDDESH

2. Is period mein khaali haath drill men Kadwar Sizing, Teen File Banana, Khuli Line aur Nikat Line men March sihkana hai.

TARTIB

3. Yeh Sabak ko teen bhagon mein chalaya jayega:-
- (a) Bhag I - Kadwar Sizing.
 - (b) Bhag II - Teen File Banana.
 - (c) Bhag III - Khuli Line aur Nikat Line men March.

BHAG I : KADWAR SIZING

4. **Zarurat.** Kadwar sizing ki zarurat drill me hamesha hoti hai, khas kar ke Ceremonial Drill ke liye. Is men pure squad ko ke line men khada karten hai taki Lamba sabse dahine khada ho aur size wise chota uske baen khada ho. Kadwar ki hui parade aur squad, dur se dekhne main achchhe aur sundar lagte hai.

5. **Bayan.**

(a) Kisi bhi formation mein khade squad ko ceremonial kadwar karne ke liye word of command milta hai "squad lamba dahine -chhota baen - ek line mein kadwar khada ho", to pura squad line tod karke, sabse lamba jawan dahine, baki uske baen khade ho jayenge.

(b) Word of command milta hai "squad ginti kar" to lambe se shuru karke - ek, do, teen, char ki ginti karen. Is ke bad word of command "visham ek kadam age aur - sam kadam piche" par No 1, 3, 5 ek kadam age lenge aur, No 2, 4, 6 ek kadam piche lenge.

(c) Is ke bad word of command milta hai "No 1 khada rahe, visham dahine aur sab baen, dahine baen mud". Is word of command pe squad tej chal se bari bari se jawan No 1 ke piche milenge aur phir 'in 3s' madhya, piche aur age khade honge. Yani No1 agli line

(peheli rank) ka 1 hoga, No 3 madhya line ka 1 hoga aur No 5 pichli line ka 1 hoga. No7 fir No 2 rank ka No 1 hoga. Is trah se, squad kadwar ho jata hai, jis men lambe jawan dahine aur baen hote hain aur bich men chote jawan hote hain.

6. **Abhyas.** Isi karyawahi ka ustad squad se 'ginti se' abhayas karaen.

BHAG II : TEEN LINE BANANA

7. **Zarurat.** Jab nafri nau se jyada ho to teen file (line) banane ki karyawahi ki jaati hai.

8. **Bayan.**

(a) Jab word of command milta hai "no 1 line ban" to seekhe hue tarike ke mutabik karyawahi ki jayegi. Isi tarah No 2 bhi No 1 ke piche line ban karega aur fir No 3, No 2 ke ek kadam piche jaakar tham karega aur "up" bolega, milkar vishram karenge. Jab word of command milta hai 'No 4 line ban' to No 4 savdhan hokar march karke No 1 ke baen, baju bhar ka fasla rakhte hue tham karega, "up" bolega aur milkar vishram karenge. No 5 savdhan aur march karke No 2 ke baen aur No 4 ko cover karke tham karega, "up" bolega aur sabhi vishram karenge, no 5 line ban. Jab word of command milta hai 'No 6 line ban' to No 6 savdhan aur march karke No 3 ke baen aur No 5 ke cover karke tham karenge, "up" bolega aur milkar sabhi vishram karenge. Baki nafri ko line ban karne ke liye karyawahi isi tarah karte jayen.

(b) Agar squad ki nafri 11,14,17,20 ki ginti ki ho to hamesha baen se No 2 file aur madhya line mein khaali jagah rakhi jayegi. Agar squad ki nafri 10, 13, 16,19 ki ginti ki ho to baen se No 2 file madhya aur pichhli line mein khaali jagah rakhi jayegi. Agar squad do ko dahine baen ki taraf munh karna ho to word of command "squad teenon teen mein dahine / baen chalega dahine / baen mud". Jab teen jawan age hon baki unke piche se cover kiye hon, use teenon teen kahte hain, baki word of command aur karyawahi usi tarah hai jaise ek file mein aap ko bata diya hai. Squad line tod.

10. **Abhyas.** Isi karyawahi ka ustad squad se 'ginti se' abhayas karaen.

BHAG III : KHULI LINE AUR NIKAT LINE CHAL

Khuli Line Chal

11. **Zarurat.** Jab squad ko shastr qawaid karana ho, ya badi paradeon mein VIP ko nirikshan karana ho toh 'khuli line' ki karyawahi ki jaati hai.

12. **Ginti aur Bayan se Namuna.**

(a) Jab savdhan position se word of command milta hai "ginti se chalna khuli line chal – ek" to is word of command par baen paon ko 6 inch uthate hue 30 inch age dabaen aur bolen 'ek'. Is position mein dekhne wali baten - baen paon 30 inch age poora laga hua, dahine paon ka panja zamin par, aeedi uthi hui, dono tange kasi hui baki position savdhan.

(b) Jab word of command milta hai squad 'do'. Toh dahine paon ko 6 inch uthate hue 15 inch age len aur baen paon ko teji se uthate hue dahine paon ke saath savdhan position mein milaen aur shout karen 'do'. Is position mein dekhne ki baten - pahle wali jagah se 45 inch ka fasla tai kiya hua aur position savdhan.

13. **Abhyas.** Isi karyawahi kaustad squad se 'ginti se' abhayas karaen.

Nikat Line Chal

14. **Zarurat.** Jab nirikshan ho jata to march karne se pahle 'nikat line' ki karyawahi ki jaati hai.

15. **Ginti aur Bayan se Namuna.**

(a) Jab savdhan position se word of command milta hai “ginti se chalna -nikati line chal- ek” to is word of command par baen paon ko 6 inch upar aur age se uthate hue 30 inch pichhe dabean aur badan ka bojh baen paon par le jayen aur bolen ‘ek’. Is position mein dekhne ki baten - baen paon 30 inch pichhe pura laga hua, badan ka bojh baen par, dahine paon ka eri lagi hui aur panja khara hua dono tange kasi hui baki position savdhan.

(b) Jab word of command milta hai squad ‘do’. Toh dahine paon ko 6 inch upar uthate hue baen paon se 15 inch pichhe barhaen aur baen paon ko teji se uthate hue dahine paon ke saath savdhan position mein lagean aur shout karen ek ‘do’. Is position mein dekhne ki baten - pahli wali jagah se 45 inch ka fasla tai kiya hua aur position savdhan.

16. **Abhyas.** Isi karyawahi ka ustad squad se ‘ginti se’ abhayas karaen.

LESSON PLAN : FD 4
KHADE KHADE SALUTE KARNA, PARADE PAR, VISARJAN AUR LINE TOD

Period	-	One
Type	-	Lecture / Practice
Code	-	FD 4
Term	-	I (SD/SW)

Time Plan

1.	(a)	Khade Khade Salute Karna	-	10 Min
	(b)	Parade par	-	10 Min
	(c)	Visarjan	-	10 Min
	(d)	Line Tod	-	10 Min

UDDESH

2. Is period mein khaali haath drill men Khade Khade Salute Karna, Parade Par, Visarjan aur Line Tod ki karyawahi sihkana hai.

TARTIB

3. Yeh sabak ko char bhagon mein chalaya jayega:-
- | | | | |
|-----|----------|---|---------------------------|
| (a) | Bhag I | - | Khade Khade Salute Karna. |
| (b) | Bhag II | - | Parade par. |
| (c) | Bhag III | - | Visarjan. |
| (d) | Bhag IV | - | Line Tod. |

BHAG I : KHADE KHADE SALUTE KARNA

4. **Zarurat.** Jab ham kisi jagah par khade hon aur, hamare samne se koi bhi salute lene wale adhikari gujren to unhen izzat dene ke liye 'khade-khade samne salute' ki karyawahi ki jaati hai. Isi tarah, dahine salute va baen salute ki karyawahi ki jaati.

5. **Ginti aur Bayan se Namuna.**

(a) Jab word of command milta hai "ginti se salute karna samne salute -ek" to is word of command par dahine baju ko dahine taraf sidha uthate hue kandhe ke barabar layen aur kohni se modte hue anguliyon ko sidhe aur milate hue kalme wali anguli ko dahine ankh ki bhaown se 1 inch upar lagaen, shouting karen 'ek'. Is position mein dekhne ki baten - dahine haath ki anguliyon aur angutha seedha aur mile hue, kalme wali anguli dahine ankh ke bshown se 1 inch aur beech mein kalai se kohni tak 45 degree ke angle par, nigah samne, baki position savdhan.

(b) Jab word of command milta hai squad “do” to, dahine haath ko nazdik ke raste se teji se giraen, aur shout karen ‘do’. Is position mein dekhne ki baten - position savdhan.

6. **Abhyas.** Ustad ke word of command pe squad isi kayawahi ka ginti se abhyas karen.



Samne Salute

BHAG II : PARADE PAR

7. **Zarurat.** Jab platoon ya troops kisi bhi formation mein drill ground ke kinare par khade hon aur unhen parade mein hazir karne ke liye ‘parade par’ kiya jata hai. Platoon ko parade par lane se pahle dahina darshak mangwaya jata hai. Squad mein squad commander, platoon mein platoon Hav, company mein CHM dahina darshak hota hai. Darshak ko cover nahin kiya jata hai.

8. **Bayan se Namuna.**

(a) Jab vishram position se word of command milta hai dahina darshak to is word of command par savdhan hon, teen ka thahrao dete hue march karen aur 15 kadam par tham karen aur dahine se saj karen. Is position se word of command milta hai darshak hilo mat to vishram karen.

(b) Abhi word of command, “squad parade par”, to squad darshak ke baen aakar tham karen, baju uthakar ‘dahine se saj’ ki karyawahi karen, bari-bari baju giraen aur bari –bari vishram karen. Baen wale dono jawan milkar vishram karen.

9. **Abhyas.** Ustad ke word of command pe squad isi kayawahi ka ginti se abhyas karen.

BHAG III : VISARJAN

10. **Zarurat.** Jab dubara fall in nahi karna ho aur officer parade par hazir hon to visarjan ki karyawahi ki jaati hai.

11. **Bayan se Namuna.** Jab savdhan position se word of command milta hai “squad / platoon visarjan” to, dahine mud karke salute karen aur, teen kadam age lekar tham karen aur, sidhe age nikal jayen lekin, sikhlai mein squad ke upar control rakhne ke liye dubara baen mud karen aur savdhan position mein khade rahen.

12. **Abhyas.** Ustad ke word of command pe squad isi kayawahi ka ginti se abhyas karen

BHAG IV : LINE TOD

13. **Zarurat.** Jab thodi der ke liye aram dena ho aur dubara fall in karna ho to 'line tod' ki karyawahi ki jaati hai.
14. **Bauan se Namuna.** Line tod ki karyawahi usi tarah hai jaise visarjan mein seekh chuke hain - lekin line tod par salute nahin kiya jayega.
15. **Abhyas.** Ustad ke word of command pe squad isi kayawahi ka ginti se abhyas karen.

LESSON PLAN : FD 5
TEJ CHAL - THAM AUR DHIRE CHAL - THAM

Period	-	One
Type	-	Lecture / Practice
Code	-	FD 5
Term	-	I (SD/SW)

Time Plan

1. (a) Tej Chal –Tham - 20 Min
- (b) Dhire Chal - Tham - 20 Min

UDDESH

2. Is period mein khaali haath drill men Tez Chal , Dhire Chal aur Tham ki karyawahi sihkana hai.

TARTIB

3. Yeh sabak ko do bhagon mein chalaya jayega:-
 - (a) Bhag I - Tej Chal aur Tham – Bayan va Namuna.
 - (b) Bhag II - Dhire Chal aur Tham – Bayan va Namuna.

BHAG I : TEJ CHAL AUR THAM

4. **Zarurat.** Discipline ko kayam rakhte ha ek jagah se dusri jagah jane ke liye 'tej chal' kiya jata hai. Kadam ki lambai 30 inch hoti hai. Regiment / units ki kadam ki raftaar ek minute mein 120 kadam, rifle units 140, NCC cadets 116 kadam aur NCC girls cadets 110 kadam per minute hoti hai. Lekin, shuru mein recruits 135 kadam ki raftaar se march karte hain.

5. **Ginti aur Bayan se Namuna.**

(a) Jab savdhan position se word of command milta hai "ginti se chalna tej chal ek" to, is word of command per baen paon ki aaedi 30 inch par age lagaen, dahina baju age kandhe ki line mein, baen baju pura piche, mutthi kudrati taur par band rakhen, yahan tak ke movement ko dekhien. Is position mein dekhne ki baten. - Baen paon ki aaedi zamin par lagi hui, panja khada, dahina paon pura zamin par, badan ka boj, dahine paon par, dono tangen kasi hui, dahina baju age, kandhe ki line mein aur baen haath piche, mutthi kudrati taur par band, baki position savdhan.

(b) Jab word of command milta hai "squad do" to is word of command par paon aur baju ki apas mein badli Karen, shout karen 'do'. Is position mein dekhne ki baten - dahine paon ki aaedi lagi hui, panja khada hua, bayan paon pura zamin par laga hua aur badan ka boj baen paon par, bayan baju age dahina baju piche.

(c) Jab word of command milta hai "squad ek" to paon aur bajuon ki phir badli karen. Is position mein dekhne ki baten - jo isse pahle seekh chuke hain.

(d) Jab word of command milta hai "squad tham". Ye word of command us samay milta hai jab bayan paon zamin par ho ya, dahina paon baen paon ko cross kar raha ho to, dahine paon ko 30 inch par pura age rakhen, shout karen 'khaali', phir baen paon ko upar utha kar dahine paon ke saath dabaen aur dahine paon ko teji se 6 inch uthate hue baen paon ke saath savdhan position par lagaen, shout karen 'ek-do'. Is position mein dekhne ki baten - position savdhan.

6. **Abhyas.** Ustad ke word of command pe squad ginti se abhyas Karen.

BHAG II - DHIRE CHAL AUR THAM

7. **Zarurat.** Badi parade mein, parade ke nirikshan ke liye VIP ke age jo pilot chalte hain woh dhire chal se chalte hain. Kadam ki lambai 30 inch, kadam ki raftar, 1 minute mein 70 kadam hoti hai.

8. **Kadam Tol Kar Bayan se Numuna.**

(a) Jab savdhan position se word of command milta hai, 'kadam tol kar dhire chalna - bayan paon age', to, is word of command par baen paon ko 15 inch age teji se, kadam tol kar ruk jayen aur shout karen age. Is position mein dekhne ki baten - dahina paon pura zamin par laga hua aur, badan ka bojh dahine paon par, bayan paon dahine paon se 15 inch age, zamin se alag, panja zamin ki taraf kheencha hua, baki position savdhan.

(b) Jab word of command milta hai "age badh" to is word of command par baen paon ko 15 inch aur age badha kar panja pahle zamin par lagaen aur shouting karen 'badho'. Is position mein dekhne ki baten - bayan paon pura zamin par laga hua, badan ka bojh pura baen paon par, dahine paon ka panja zamin par, aedi uthi hui, dono tangen kasi hui, baki position savdhan.

(c) Jab word of command milta hai "dahina paon age" to dahine paon ko 15 inch age baen paon se nikalen aur shout karen 'age'. Is position mein dekhne ki baten jo aap baen paon age mein seekh chuke hain uske ulta.

(d) Jab word of command milta hai, "age badh" to dahine paon ko aur 15 inch age badha kar panja pahle zamin par lagaen aur shouting karen 'badho'. Is position mein dekhne ki baten, baen paon ke ulta.

(e) Jab word of command milta hai "bayan paon age" to baen paon ko age len aur shout karen "age". Is position mein dekhne ki baten jo isse pahle seekh chuke hain.

(f) Jab word of command milta hai "tham", ya word of command us samay milta hai jab bayan paon dahine paon ko cross kar raha ho ya dahina paon zamin par laga ho toh baen paon ko 15 inch age lekar ,uthakar dabaen aur teji se dahine paon ko 6 inch uthakar baen paon ke saath milaen aur shout karen "ek-do".

9. **Abhyas.** Ustad ke word of command pe kadam tol kar abhyas karen.

LESSON PLAN : FD 6
DAHINE, BAEN, AGE AUR PICHE KADAM LENA

Period	-	One
Type	-	Lecture / Practice
Code	-	FD 6
Term	-	II (SD/SW)

Time Plan

1.	(a)	Dahine Baju Kadam Lena	-	10 Min
	(b)	Baen Baju Kadam Lena	-	10 Min
	(c)	Age Kadam Lena	-	10 Min
	(d)	Piche Kadam Lena	-	10 Min

UDDESH

2. Is period mein khaali haath drill men Dahine, Baen, Age aur Piche Kadam Lene ki karyawahi sihkana hai.

TARTIB

3. Yeh sabak ko cahr bhagon mein chalaya jayega:-
- | | | | |
|-----|----------|---|---|
| (a) | Bhag I | - | Dahine Baju Kadam Lena – Bayan va Namuna. |
| (b) | Bhag II | - | Baen Baju Kadam Lena– Bayan va Namuna. |
| (c) | Bhag III | - | Age Kadam Lena - Bayan va Namuna. |
| (d) | Bhag IV | - | Piche Kadam Lena - Bayan va Namuna. |

BHAG I : DAHINE BAJU KADAM LENA

4. **Zarurat.** Jab khade khade squad ka dahine wale squad se bagali fasla jyada ho, to usko pura karne ke liye “dahina baju kadam” lene ki karyawahi ki jaati hai. Kadam ki lambai 12 inch aur word of command se - 4 kadam tak dahina baju chal sakte hain. Lagatar word of command dekar 12 kadam tak. Agar isse jyada fasla ho toh dahine mud kar pura kiya jata hai.

5. **Ginti aur Bayan se Namuna.**

(a) Jab savdhan position se word of command milta hai “ginti se chalna - ek kadam dahina baju chal –ek” to, is word of command par dahine paon ko 6 inch upar uthate hue 12 inch ke fasle par dahine taraf dabaen aur shout karen ek. Is position mein dekhne ki baten - aeedi se aeedi ka fasla 12 inch, badan ka bojh dono paon par baki position savdhan.

(b) Jab word of command milta hai “squad do”, to is word of command par baen paon ko 6 inch upar uthate hue dahine paon ke saath savdhan position mein dabaen aur shout karen ‘do’. Is position mein dekhne ki baten - position savdhan.

6. **Abhyas.** Ustad ke word of command pe, squad se ginti se abhyas Karaen.

BHAG II : BAEN BAJU KADAM LENA

7. **Zarurat.** Jab khade khade squad ka baen wale squad se bagali fasla jyada ho gaya ho toh usko pura karne ke liye baen baju kadam lene ki karyawahi ki jaati hai. Kadam ki lambai 12 inch aur word of command se 4 kadam tak, lagatar 12 kadam tak ja sakte hain.

8. **Ginti aur Bayan se Namuna.**

(a) Jab savdhan position se word of command milta hai “ginti se chalna ek kadam baen baju chal – ek” to, is word of command par baen paon ko 6 inch upar uthate hue 12 inch ke fasle par baen taraf dabaen aur shout karen ‘ek’. Is position mein dekhne ki baten, aeedi se aeedi ka fasla 12 inch, badan ka bojh dono paon par, baki position savdhan.

(b) Jab word of command milta hai “squad do” to, dahine paon ko 6 inch upar uthate hue baen paon ke saath savdhan position mein lagaen. Is position mein dekhne ki baten - position savdhan.

9. **Abhyas.** Ustad ke word of command pe, squad se ginti se abhyas Karaen.

BHAG III : AGE KADAM LENA

10. **Zarurat.** Jab khade khade squad ka agle squad se thoda jyada fasla ho jaye toh fasle ko pura karne ke liye age kadam lene ki karyawahi ki jaati hai. Age kadam lene ke liye kadam ki lambai 30 inch aur aakhiri kadam 15 inch. Word of command se age teen kadam tak ja sakte hain.

11. **Ginti aur Bayan se Namuna.**

(a) Jab savdhan position se word of command milta hai “ginti se chalna ek kadam age chal -ek” to, is word of command par baen paon ko 6 inch uthate hue 30 inch age lagaen aur agle paon par sawar ho jayen shouting karen ‘ek’. Is position mein dekhne ki baten - baen paon 30 inch par pura age laga hua, badan ka bojh baen paon par, dahine paon ka panja zamin par aeedi uthi hui, baki position savdhan.

(b) Jab word of command milta hai “squad do” to, is word of command par dahine paon ko 6 inch utha kar baen paon ke saath teji se savdhan position mein dabaen aur shout karen ‘do’. Is position mein dekhne ki baten - position savdhan.

12. **Abhyas.** Ustad ke word of command pe, squad se ginti se abhyas Karaen.

BHAG IV : PICHE KADAM LENA

13. **Zarurat.** Jab khade khade squad ka pichhle squad se thoda jyada fasla ho gaya ho toh fasle ko pura karne ke liye piche kadam lene ki karyawahi ki jaati hai. Kadam ki lambai 30 inch aur 3 kadam piche ja sakte hain.

14. **Ginti aur Bayan se Namuna.**

(a) Jab savdhan position se word of command milta hai “ginti se chalna ek kadam piche chal - ek” to, is word of command par baen paon ko 6 inch upar uthate hue 30 inch par pura piche dabaen aur shouting karen ‘ek’. Is position mein dekhne ki baten - baen

paon 30 inch par pura piche laga hua aur badan ka bojh baen paon par, dahine paon ki aaedi lagi hui aur panja khada hua, baki position savdhan.

(b) Jab word of command milta hai "squad do" to, is word of command par dahine paon ko 6 inch upar uthate hue baen paon ke saath savdhan postion mein milaen, shout karen 'do'. Is position mein dekhne ki baten - postion savdhan.

15. **Abhyas.** Ustad ke word of command pe, squad se, ginti se abhyas karaen.

LESSON PLAN : FD-7
TEJ CHAL SE MUDNA

Period	-	One
Type	-	Lecture / Practice
Code	-	FD 7
Term	-	I / II (SD/SW)

Time Plan

1.	(a)	Tej Chal se Dahine Mudna	-	15 Min
	(b)	Tej Chal se Baen Mudna	-	15 Min
	(c)	Tej Chal se Piche Mudna	-	10 Min

UDDESH

2. Is period mein khaali haath drill Tez Chal se Mudne ki karyawahi sihkana hai.

TARTIB

3. Yeh sabak ko teen bhagon mein chalaya jayega:-
- | | | | |
|-----|----------|---|---|
| (a) | Bhag I | - | Tej Chal se Dahine Mudna - Bayan va Namuna. |
| (b) | Bhag II | - | Tej Chal se Baen Mudna - Bayan va Namuna. |
| (c) | Bhag III | - | Tej Chal se Piche Mudna - Bayan va Namuna. |

BHAG I : TEJ CHAL SE DAHINE MUDNA

4. **Zarurat.** Jab tej chal se march karte hue kisi simmat ko ja rahe hon, aur 90 degree par apni simmat ya formation ko dahini taraf badli karni ho to, dahine mud ki karyawahi ki jaati hai.

5. **Ginti aur Bayan se Namuna.**

(a) Tej chal se word of command milta hai "ginti se mudna dahine mud - ek", ye word of command us samay milta hai jab dahina paon baen paon ko cross kar raha ho ya, baen paon zamin par laga ho to, is word of command par dahine paon ko 15 inch age zamin par rakhen aur chalti halat mein ruk jayen aur shouting karen 'ek'. Is position mein dekhne ki baten - dahina paon zamin par, badan ka panja zamin par aur aedi uthi hui, baen baju age dahina baju piche chalti halat mein.

(b) Jab word of command milta hai 'squad do' to, is word of command par baen paon ko dadam taal ki halat main age uthaen, aur baju savdhan ki halat mein le jayen shout karen 'do'. Is position mein dekhne ki baten, dahina paon pura zamin par, badan ka bajh dahine paon par, baen paon kadam taal ki halat mein baki position savdhan.

(c) Jab word of command milta hai "squad teen" to, dahine paon ki aedi par dahine taraf 90 degree par ghoom jayen aur baen paon ko savdhan position mein lagaen aur

dahine paon ko teji se 15 inch age kadam tol ki halat mein nikalen aur shouting karen teen. Is position mein dekhne ki baten - baen paon pura zamin par laga hua badan ka bojh baen paon par dahina paon 15 inch age kadam tol ki halat mein baki position savdhan.

(d) Jab word of command milta hai "squad char" to, dahine paon ko 15 inch age aedi lagate hue tej chal ko shuru karen aur shout karen 'badho'. Squad char badho tham khaali ek-do. Jaise the.

6. **Abhyas.** Ustad ke word of command pe, squad se ginti se abhyas karaen.

BHAG II : TEJ CHAL SE BAEN MUDNA

7. **Zarurat.** Jab tej chal se march karte hue kisi bhi simmat ko ja rahe hon, aur 90 degree par apni simmat ya formation ko baen taraf badli karni ho to, baen mud ki karyawahi ki jaati hai.

8. **Ginti aur Bayan se Namuna.**

(a) Tej chal se word of command milta hai "ginti se mudna baen mud – ek", ye word of command us samay milta hai jab baen paon dahine paon ko cross kar raha ho ya dahine paon ki aedi zamin par lag rahi ho toh baen paon ko 15 inch age zamin par rakhen aur chalti halat mein ruk jayen, shouting karen ek. Is position mein dekhne ki baten - baen paon pura zamin par badam ka bojh baen paon par dahine paon ka panja jaimn par aedi utthi hui, dahina baju age baen baju piche chalti halat mein.

(b) Jab word of command milta hai "squad do" to, is word of command par dahine paon ko kadam taal ki halat mein age uthaen aur baju savdhan position mein layen, shout karen 'do'. Is position mein dekhne ki baten - baen paon pura zamin par laga hua badan ka bojh baen paon par, dahina paon kadam taal ki halat mein, baki position savdhan.

(c) Jab word of command milta hai "squad teen" to, baen paon ki aedi par baen taraf 90 degree par ghoom jayen aur dahine paon ko savdhan position mein lagaen aur baen paon ko teji se 15 inch age kadam tol ki halat mein, baki position savdhan.

(d) Jab word of command milta hai "squad char" to, baen paon ko 15 inch age aedi lagakar tej chal shuru karen aur shout karen badho. Squad char badho - squad tham khaali ek-do.

9. **Abhyas.** Ustad ke word of command pe, squad se ginti se abhyas karaen.

BHAG III : TEJ CHAL SE PICHE MUDNA

10. **Zarurat.** Jab tej chal se march karte hue kisi bhi simmat ko ja rahe hon, aur 180 degree par formation ko kayam rakhte hue simmat ki badli karni ho to piche mud ki karyawahi ki jaati hai.

11. **Ginti aur Bayan se Namuna.**

(a) Tej chal se word of command milta hai "ginti se mudna piche mud –ek", ye word of command us samay milta hai jab baen paon dahine paon ko cross kar raha ho ya dahine paon ki aedi zamin par lag rahi ho toh baen paon ko khaali jane den, dahine paon ko 15 inch age lagate hi chalti halat mein ruk jaen, shout karen 'khaali ek'. Is position mein dekhne ki baten - dahine mud ke No 1 movenemt ki tarah.

(b) Jab word of command milta hai "squad do" to, dahine paon ki aedi par 90 degree dahine taraf ghoom jayen aur baen paon ko dahine paon ke saath savdhan postion mein lagaen, shout karen 'do'. Is postion mein dekhne ki baten, 90 degree dahine turn kiya hua, baki postion savdhan.

(c) Jab word of command milta hai "squad teen" to, is word of command par baen paon ke panje par dahine taraf 90 degree par aur ghoom jayen, saath hi dahine paon ko 6 inch uthakar savdhan position mein lagaen aur shout karen teen. Is position mein dekhne ki baten - position savdhan.

(d) Jab word of command milta hai "squad char" to, position aur direction ko durust karne ke liye baen paon ko 6 inch upar uthate hue dahine paon ke saath savdhan position mein lagaen. Is position mein dekhne ki baten - 180 degree piche turn kiya hua baki position savdhan.

(e) Jab word of command milta hai "squad panch" to, dahine paon ko 30 inch age nikalkar tej chal ki karyawahi shuru karen aur shout karen 'badho'. Squad panch - badho tham kaho ek-do.

12. **Abhyas.** Ustad ke word of command pe, squad se ginti se abhyas karaen.

LESSON PLAN : FD 8
TEJ CHAL SE SALUTE KARNA

Period	-	One
Type	-	Lecture / Practice
Code	-	FD 8
Term	-	I / II (SD/SW)

Time Plan

1.	(a)	Tej Chal se Samne Salute Karna	-	10 Min
	(b)	Tej Chal se Dahine Salute Karna	-	15 Min
	(c)	Tej Chal se Baen Salute Karna	-	15 Min

UDDESH

2. Is period mein khaali haath drill Tez Chal se Salute karne ki karyawahi sihkana hai.

TARTIB

3. Yeh sabak ko teen bhagon mein chalaya jayega:-
- | | | | |
|-----|----------|---|--|
| (a) | Bhag I | - | Tej Chal se Samne Salute Karna - Bayan va Namuna. |
| (b) | Bhag II | - | Tej Chal se Dahine Salute Karna - Bayan va Namuna. |
| (c) | Bhag III | - | Tej Chal se Baen Salute Karna - Bayan va Namuna. |

BHAG I : TEJ CHAL SE SAMNE SALUTE KARNA

4. **Zarurat.** Jab hamein kisi Officer ya, JCO se baat karni ho ya, unhone hamen apne paas bulaya ho to unhen izzat dene ke liye tej chal se samne salute ki karyawahi ki jaati hai.

5. **Ginti aur Bayan se Namuna.**

(a) Tej chal se word of command milta hai "ginti se salute karna samne salute – ek" ye word of command usi tarah milta hai jaise tej chal mein tham karte hain. Is position mein dekhne ki baten - position savdhan.

(b) Jab word of command milta hai "squad do" to, is word of command par ek bar khade khade samne salute ki karyawahi karen. Squad do - ek-do-teen-ek. Is position mein dekhne ki baten, ek bar khade khade samne salute ki karyawahi ki hui, baki position savdhan.

(c) Jab word of command milta hai "squad teen" to, is word of command par dubara salute karen. Squad teen, ek-do-teen-ek. Is position mein dekhne ki baten - position No 2 ki tarah.

(d) Jab word of command milta hai “squad char” to, is word of command par piche mud karen. Squad char - ek-do-teen-ek, (dubare piche mud karen). Is position mein dekhne ki baten - 180 degree direction ki badli ki hui baki position savdhan .

(e) Jab word of command milta hai “squad panch” to, baen paon se tej chal shuru karen aur shout karen ‘badho’. Squad panch - badho -squad tham khaali ek-do.

6. **Abhyas.** Ustad ke word of command pe, squad se ginti se abhyas karaen.

BHAG II : TEJ CHAL SE DAHINE SALUTE KARNA

7. **Zarurat.** Jab tej chal se march karte hue kisi bhi simmat ko ja rahe hon, dahine taraf koi salute lene wale adhikari milen to unhen izzat dene ki liye dahine salute ki karyawahi ki jaati hai.

8. **Ginti aur Bayan se Namuna.**

(a) Tej chal se word of command milta hai ginti se salute karna dahine salute ek, ya word of command us samay milta hai jab dahina paon baen paon ko cross kar raha ho ya baen paon ki aedi zamin par lag rahi ho, toh dahine paon ko khaali aur baen paon ki aedi lagte hi dahine salute karen aur chalti halat mein ruk jaen, shout karen ‘kahli ek’.Is postion mein dekhne ki baten - baen paon ki aedi zamin par panja khada, dahina paon pura zamin par, badan ka bojh dahine paon par, dono tange kasi hui, salute seekhe hue tarike se kiya hua, nigh puri dahine taraf, baki position savdhan.

(b) Jab word of command milta hai “squad do” to, dahine paon se do ki ginti shuru karte hue panch ki ginti tak march karen aur ruk jayen. Sqad do - do-teen –char-panch. Is position mein dekhne ki baten, panch kadam ka jaimni fasla tai kiya hua baki position No 1 ki tarah.

(c) Jab word of command milta hai “squad teen” to, dahine paon ki aedi ka lagna chehre ko age lena salute ko girana ek saath karen aur shout karen ‘down’. Squad teen - down. Is position mein dekhne ki baten, dahine paon ki aedi 30 inch age lagi hui panja khada badan do bojh baen paon par, slaute giraya hua, baki position savdhan.

(d) Jab word of command milta hai “squad char” to baen paon se tej chal ki karyawahi shuru karen aur shout karen badho. Squad char - badho squad tham - khaili ek-do.

9. **Abhyas.** Ustad ke word of command pe, squad se ginti se abhyas karaen.

BHAG III : TEJ CHAL SE BAEN SALUTE KARNA

10. **Zarurat .** Jab tej chal se march karte hue kisi bhi simmat ko ja rahe hon, baen taraf koi salute lene wale adhikari milen toh unhem izzat dene ki liye baen salute ki karyawahi ki jaati hai.

11. **Ginti aur Bayan se Namuna.**

(a) Tej chal se word of command milta hai “ginti se salute karna baen salute -ek”, ye word of command us samay milta hai jab dahina paon baen paon ko cross kar raha ho ya baen paon ki aedi zamin par lag rahi ho, toh dahine paon ko khaali aur baen paon ki aedi lagte hi baen salute karen aur chalti halat mein ruk jaen, shouting karen khaali ek.Is postion mein dekhne ki baten - baen paon ki aedi zamin par panja khada, dahina paon



pura zamin par, badan ka bojh dahine paon par, dono tangent kasi hui, salute seekhe hue tarike se mutabik kiya hua, nigah puri baen taraf, baki position savdhan.

(b) Jab word of command milta hai “squad do” to, dahine paon se march ko jari karen aur panch ki ginti karke ruk jayen. Squad do - do-teen –char-panch. Is position mein dekhne ki baten, panch kadam ka jaimni fasla tai kiya hua baki position No 1 ki tarah.

(c) Jab word of command milta hai “squad teen” to, dahine paon ki aedi ka lagna chehre ko samne lana salute ko girana ek saath karen aur shouting karen down,. Squad teen - down. Is position mein dekhne ki baten - dahine paon 30 inch age, aedi lagi hui panja khada baen paon pura zamin par, badan do bojh baen paon par, slaute giraya hua, baki position savdhan.

(d) Jab word of command milta hai “squad char” to, baen paon se tej chal ki karyawahi shuru karen aur shout karen ‘badho’. Squad char - badho- squad tham -khaili ek-do.

12. **Abhyas.** Ustad ke word of command pe, squad se ginti se abhyas karaen.



Baen Salute

LESSON PLAN : FD 9
TEZ KADAM TAAL AUR THAM

Period	-	One
Type	-	Lecture / Practice
Code	-	FD 9
Term	-	II (SD/SW)

Time Plan

1.	(a)	Tez Kadam Taal aur Tham	-	10 Min
	(b)	Abhyas	-	30 Min

UDDESH

2. Is period mein khaali haath drill Tez Kadam Taal aur Tham ki karyawahi sihkana hai.

TARTIB

3. Yeh sabak do bhag mein chalaya jayega:-
- (a) Bhag I - Tej Kadam Taal aur Tham - Bayan va Namuna.
- (b) Bhag II - Abhyas.

BHAG I : TEZ KADAM TAAL AUR THAM

4. **Zarurat.** Covering, dressing aur fasle ko pura karne ke liye khade khade Tez Kadam Taal aur Tham ki karyawahi ki jaati hai.

5. **Bayan se Namuna.**

(a) Jab savdhan position se word of command milta hai "tez kadam taal" to, is word of command par baen paon ko teji se age aur upar uthane, aur teji se baen paon zamin par dabaen, aur aedi ko zamin par savdhan position mein layen, jab aedi jameen par lag jaati hai toh dahine paon ko teji se upar 12 inch uthate hue baen paon ki tarah jameen par lagaen. Isi tarah paon ki apas mein badli karte jayen,

(b) Jab word of command milta hai "squad tham", ye word of command us samay milta hai jab baen paon zamin par lag raha ho ya dahina paon pura utha hua ho to, dahine paon ko teji se savdhan position me dabaen aur shout karen 'up'.

BHAG II : ABHYAS

6. **Abhyas.** Ustad ke word of command pe, squad se ginti se abhyas karaen.

LESSON PLAN : FD 10
TEJ KADAM TAAL SE KADAM BADALNA

Period	-	One
Type	-	Lecture / Practice
Code	-	FD 10
Term	-	II (SD/SW)

Time Plan

1.	(a)	Tez Kadam Taal se Kadam Badalna	-	10 Min
	(b)	Abhyas	-	30 Min

UDDESH

2. Is period mein khaali haath drill Tez Kadam Taal se Kadam Badalne ki karyawahi sikhana hai.

TARTIB

3. Yeh sabak do bhag mein chalaya jayega:-

- | | | | |
|-----|---------|---|---------------------------------------|
| (a) | Bhag I | - | Tej Chal Kadam Taal se Kadam Badalna. |
| (b) | Bhag II | - | Abhyas. |

BHAG I : TEJ KADAM TAAL SE KADAM BADALNA

4. **Zarurat.** Jab tej kadam taal kar rahe hon aur, agar kisi jawan ka dusre jawan se kadam tut jaye to, kadam badal ki karyawahi karke kadam milaya jata hai.

5. **Bayan se Namuna.**

(a) Jab tej kadam taal se word of command milta hai "kadam badal", ya word of command us samay milta hai jab baen / dahina paon zamin par ho to, is word of command par jis paon ko do bar kadam taal karna ho us paon par kadam aur dusre paon par badal bola jayega (jis paon ko do bar kadam taal kiya ho us paon par shout karen baen, baen/dahina, dahina).

(b) Word of command - tej kadam taal, baen dahina kadam badal- baen baen dahina squad tham -ek-do. Is position mein dekhne ki baten, tej kadam taal se kadam badal ki karyawahi ki hui baki position savdhan.

BHAG II : ABHYAS

6. **Abhyas.** Ustad ke word of command pe, squad se ginti se abhyas karaen.

LESSON PLAN : FD 11
TEENON TEEN SE EK FILE AUR EK FILE SE TEENON TEEN BANANA

Period	-	One
Type	-	Lecture / Practice
Code	-	FD 11
Term	-	II (SD/SW)

Time Plan

1.	(a)	Teeon Ten se Ek File Banana	-	15 Min
	(b)	Ek File se Teeon Ten Banana	-	35 Min

UDDESH

2. Is period mein khaali haath drill Teeon Ten se Ek File Banana aur Ek File se Teeon Ten Banana ki karyawahi sihkana hai.

TARTIB

3. Yeh sabak do bhag mein chalaya jayega:-
- | | | | |
|-----|---------|---|------------------------------|
| (a) | Bhag I | - | Teeon Ten se Ek File Banana. |
| (b) | Bhag II | - | Ek File se Teeon Ten Banana. |

BHAG I : TEENON TEEN SE EK FILE BANANA

4. **Zarurat.** Jab teenon teen mein march karke ja rahe hon to, kisi tang raste se ya pul ya lecture hall mein jana ho to, ek file banane ki karyawahi ki jaati hai aur jab pul ya tang raste ko cross kar liya jata hai toh ek file se teenon teen banaya jata hai.

5. **Bayan.** Jab teenon teen se word of command milta hai "ek file bana - agli line tej chal" to, agli line (sabse baen wali line) tej chal ki karyawahi shuru karti hai. Jab agli line ka baen wala (sabse aakhiri) jawan Madhya line ke paas se gujarta hai to, madhya line tej chal ki karyawahi karti hai. Isi tarah pichhli line tej chal se karyawahi karti hai.

6. **Abhyas.** Ustad ke word of command pe, squad se abhyas karaan.

BHAG II : EK FILE SE TEENON TEEN BANANA

7. **Bayan.** Jab ek file se word of command milta hai "squad teeno teen banaye ga - Madhya aur pichhli line tej chal" to, Madhya aur pichhli line dono tej chal karke apni apni jagh jayenge. Rifle ke bayonet stud par charhaen. "Squad sangeen - ek-do-teen-char". Is position mein dekhne wali baten, baen haath ki charon angulian sidhe angutha mila hua, baen baju seedha, sangeen rifle mein laga hua. "Squad savdhan" to, is word of command par rifle ko piche khinchte hue savdhan postion mein layen. Is position mein dekhne ki baten, position savdhan.

6. **Abhyas.** Ustad ke word of command pe, squad se abhyas karaan.

LESSON PLAN : AD 1
RIFLE KE SATH SAVDHAN, VISHRAM AUR ARAM SE

Period	-	One
Type	-	Lecture / Practice
Code	-	AD 1
Term	-	I (SD/SW)

Trq Aid

1. Rifles.

Time Plan

2. (a) Rifle ke Sath Savdhan - 20 Min
- (b) Rifle ke Sath Vishram aur Aaram Se - 20 Min

UDDESH

3. Is period mein rifle ke sath Savdhan Vishram aur Aaram Se ki karyawahi sikhana hai.

TARTIB

4. Yeh sabak do bhagon mein chalaya jayega:-
 - (a) Bhag I - Rifle ke Sath Savdhan.
 - (b) Bhag II - Rifle ke Sath Vishram aur Aaram Se.

BHAG I : RIFLE KE SATH SAVDHAN

5. **Zarurat.** Jab hamare pas rifle ho aur kisi senior se bat karni ho ya shastr qawaid ki koi harkat shuru karni ho toh savdhan position se shuru ki jati hai.
6. **Bayan se Namuna.** Jab word of command milta hai "squad savdhan" to, is word of command par sikhe hue tarike se paon ko harkat den. Dahine hath se rifle ko pura piche khenchte hue hel butt par sawar karen aur shout karen 'ek'. Is position me dekhne ki baten position savdhan khali hath ki tarah, rifle ki position heel butt par dahine hath ki taraf point karta hua. Kalai rifle ke piche cover kiya hua.
7. **Abhyas.** Ustad ke word of command pe, squad abhyas karen.

BHAG II : VISHRAM AUR AARAM SE

8. **Zarurat.** Senior ke sath bat khatm ho jane par vishram aur aaram se kiya jata hai.
9. **Bayan se Namuna.** Jab savdhan position se word of command milta hai "vishram" to sikhe hue tarike se baen paon ko baen taraf le jayen. Sath hi rifle ko dahine hath se age ko dhakelen aur shout karen 'ek'. Is position me dekhene ki baten, baen paon ki position jaise khali hath mein seikh chuke hain. Dahine hath se rifle pura age dhakela hua, Dahini kohni ka kham nikala hua. Bayan

baju savdhan position mein. Word of command milta hai “aram se”, to sikhe hue tarike se karyawahi karen. Is position me dekhne ki baten, jaise khali hath mein seekh chuke hain.

10. **Abhyas.** Ustad ke word of command pe, squad abhyas kare.



Savadhan



Vishram

LESSON PLAN : AD 2
RIFLE KE SATH PARADE PAR AUR SAJ

Period	-	One
Type	-	Lecture / Practice
Code	-	AD 2
Term	-	I / II (SD/SW)

Trq Aid

1. Rifles.

Time Plan

- | | | | | |
|----|-----|----------------------------------|---|--------|
| 2. | (a) | Rifle ke Sath Parade Par aur Saj | - | 10 Min |
| | (b) | Abhyas | - | 30 Min |

UDDESH

3. Is period mein rifle ke sath Parade Par aur Saj ki karyawahi sikhana hai.

TARTIB

4. Yeh sabak ek bhag mein chalaya jayega
5. **Zarurat.** Jab rifle ke sath thodi dur harkat karni ho ya, saj ki karyawahi karni ho toh samtol shastr ki karyawahi ki jati jai.
6. **Bayan se Namuna.**
 - (a) Jab savdhan position se word of command milta hai "Squad Parade Par" to, is word of command par dahine hath se rifle ko zamin se sidhe ek ya 1.5 inch upar uthate hue shout karen 'ek'. Is position mein dekhne ki baten. Rifle zamin se 1 ya 1.5 inch upar sidha uthaya hua, baki position savdhan. Is ke bad squad tez chal se rifle ko uthate hue parade par ata hai aur tham karta hai. Tham ke sath hi rifle ko zamin pe rakha jata hai.
 - (b) Is ke bad word of command milta hai "saj" to squad ki pehli line (rank) apna baen hat ko uthata hai, rifle ko samtol position me late hue, aur sikhe hue tarike se saj ki karwahi karta hai.(Jaise khali hanth drill me ki jati hai).
7. **Abhyas.** Ustad ke word of command pe squad abhyas kare.

LESSON PLAN : AD 3
RIFLE KE SATH VISARJAN AUR LINE TOD

Period	-	One
Type	-	Lecture / Practice
Code	-	AD 3
Term	-	I / II (SD/SW)

Trq Aid

1. Rifles.

Time Plan

- | | | | | |
|----|-----|-------------------------------------|---|--------|
| 2. | (a) | Rifle ke sath Visarjan aur Line Tod | - | 10 Min |
| | (b) | Abhyas | - | 30 Min |

UDDESH

3. Is period mein rifle ke sath Visarjan aur Line Tod ki karyawahi sikhana hai.

TARTIB

4. Yeh sabak ek bhag mein chalaya jayega.

RIFLE KE SATH VISARJAN AUR LINE TOD

5. Yeh karwahi usi tarah ki jati hai jaise, khali hath drill men ki jati hai, sirf farak itna hai ki, Visarjan ya Line Tod se pehele, rifle ko bagal shastra ki position men lai jati hai.

6. **Bayan se Namuna.**

(a) Jab savdhan position se word of command milta hai "squad / platoon visarjan" to, dahine mud karen, bagal shastra karen, salute karen aur, teen kadam age lekar tham karen aur, sidhe age nikal jayen.

(b) Line Tod ki karyawahi usi tarah hai jaise rifle ke sath visarjan mein seekh chuke hain - lekin line tod par bagal shastra position men, salute nahin kiya jayega.

7. **Abhyas.** Ustad ke word of command pe squad isi karyawahi ka abhyas kare.

LESSON PLAN : AD 4
BHUMI SHASTRA AUR UTHAO SHASTRA

Period	-	One
Type	-	Lecture / Practice
Code	-	AD 4
Term	-	I (SD/SW)

Trq Aid

1. Rifles.

Time Plan

2. (a) Bhumi Shastra aur Uthao Shastra - 10 Min
(b) Abhayas - 30 Min

UDDESH

3. Is period mein Bhumi Shastra aur Uthao Shastra ki karyawahi sikhana hai.

TARTIB

4. Yeh sabak do bhagon mein chalaya jayega.
(a) Bhag I - Bhumi Shastra.
(b) Bhag II - Uthao Shastra.

BHAG I : BHUMI SHASTRA

5. **Zarurat.** Jab rifle ko savdhan position se zamin pe rakhna ho to 'Bhumi Shastra' ki karyawahi ki jati hai.
6. **Bayan se Namuna.**
(a) Jab savdhan position se word of command milta hai "Bhumi Shastra" to, body ko savdhan position se sidha age ko jhukao aur shout karo 'ek'. Is position men dekhne wali baten, ghutne khule hue par aedi judi hui, rifle dahine hath men, barrel age ki taraf aur magazine bahar ki taraf zamin par touch karti hui.
(b) Jab word of command milta hai 'do' to, rifle ko zamin pe chod do, aur savdhan position men vapis ajao aur shout karo 'do'.
7. **Abhyas.** Ustad ke word of command pe squad isi karyawahi ka abhyas kare.

BHAG II : UTHAO SHASTRA

8. **Zarurat.** Jab rifle ko savdhan position se zamin se uthana ho to 'Uthao Shastra' ki karyawahi ki jati hai.

9. **Bayan se Namuna.**

(a) Jab savdhan position se word of command milta hai “Uthao Shastra” to, body ko savdhan position se sidha age ko jhukao aur shout karo ‘ek’. Is position men dekhne wali baten, ghutne khule hue par aedi judi hui, aur dahine hath, dahine toe ki line men, barrel ko pakde hue, aur rifle zamin se thodi si uthi hui.

(b) Jab word of command milta hai ‘do’ to, rifle ko zamin se tezi se utha kar savdhan position men ajao aur shout karo ‘do’.

10. **Abhyas.** Ustad ke word of command pe squad isi kayawahi ka abhyas kare.

LESSON PLAN : AD 5
BAGAL SHASTRA AUR BAJU SHASTRA

Period	-	One
Type	-	Lecture / Practice
Code	-	AD 5
Term	-	I (SD/SW)

Trq Aid

1. Rifles.

Time Plan

2. (a) Bagal Shastra aur Baju Shastra - 20 Min
(b) Abhayas - 20 Min

UDDESH

3. Is period mein Bagal Shastra aur Baju Shastra ki karyawahi sihkana hai.

TARTIB

4. Yeh sabak do bhagon mein chalaya jayega.
(a) Bhag I - Bagal Shastra.
(b) Bhag II - Baju Shastra.

BHAG I : BAGAL SHASTRA

5. **Zarurat.** Rifle ke saath ek jagah se dusri jagah jana ho toh bagal shastr se march karke jate hain. Iske alawa, badi parades mein regiment / unit contingent, bagal shatr se march past karte hain. Quarter guard mein khada sentry Nb/Sub se Captain tak ko, bagal shatr se salute karta hai.

6. **Bayan se Namuna.**

(a) Jab savdhan position se word of command milta hai, ginti se "bagal shastr ek" to, is word of command par dahine hath se rifle ko thoda upar uchhalen aur sath hi baen hath se forehand guard aur dahine hath se pistol grip ko ek sath pakden aur shout karen 'ek'. Is position mein dekhne ki baten, bayan hath kohni se kalai tak kamar belt ki line mein zamin ke mutabiki, charon angulion bahar se angutha andar se pakda hua. Dahine haath se pistol grip ko mazbuti se pakda hua, dahine haath sidha, baki position savdhan.

(b) Jab word of command milta hai "squad do" to, baen hath ko teji se savdhan position mein layen aur shout karen 'do'. Is position mein dekhne ki baten, rifle bagal shatr baaki position savdhan.

7. **Abhyas.** Ustad ke word of command pe squad isi kayawahi ka abhyas karen.

BHAG II : BAJU SHASTRA

8. **Zarurat.** Bagal Shastr se rifle ko niche lane ke liye Baju Shastr ki karyawahi ki jati hai. Parade samapti hone ke bad bhi Bagal Shastr se Baju Shastr ki karyawahi karte hain.
9. **Bayan se Namuna.**
- (a) Jab savdhan shastr se word of command milta hai, ginti se “Baju Shastr ek” to, is word of command par bayen hath se flash hider ke niche se barrel ko grip karen, aur shout karen ‘ek’. Is position mein dekhne ki baten, baen hath se barrel ko mutthi bhar pakda hua, baen hath ki kalai chati ke sath mili hui, baki position pahle ki tarah.
- (b) Jab word of command milta hai ‘squad ‘do’ to, baen hath se rifle ko sidha niche le jayen, dahine hath ko chod kar dubara rifle ke forehand guard se savdhan position ki tarah pakden, aur shout karen ‘do’. Is position mein dekhne ki baten, baen hath se flash hider U ke shape mein pakda hua, dahine hath se forehand guard ko pakda hua, charon angulian bahar se angutha andar se, savdhan position ki tarah pakda hua, rifle zamin se ek inch upar butt toe ke barabar.
- (c) Jab word command milta hai “squad teen” to, is word of command par baen hath ko savdhan position mein layen aur ko dahine hath se zamin par savdhan position mein layen, aur shout karen ‘teen’. Is position mein dekhne ki baten, bagal shatr ki karyawahi ki hui, baki position savdhan.
10. **Abhyas.** Ustad ke word of command pe squad isi kayawahi ka abhyas kare.

LESSON PLAN : AD 6
SALAMI SHASTRA

Period	-	One
Type	-	Lecture / Practice
Code	-	AD 6
Term	-	I / II / III (SD/SW)

Trq Aid

1. Rifles.

Time Plan

2. (a) Salami Shastra - 25 Min
- (b) Salami Shastra se Baju Shastra - 15 Min

UDDESH

3. Is period mein Salami Shastra aur Baju Shastra ki karyawahi sihkana hai.

TARTIB

4. Yeh sabak do bhagon mein chalaya jayega:-
 - (a) Bhag I - Salami Shastra.
 - (b) Bhag II - Salami Shastra se Baju Shastra.

BHAG I : SALAMI SHASTRA

5. **Zarurat.** Rifle ke saath salami shastr, unche darje ka salute hai. Badi parades mein ya guard of honour men VIP ko izzat den eke liye aur quarter guard mein khara sentry, Major se upar wale Officer ko izzat den eke liye Salami Shastr ki karyawahi karta hai.

6. **Bayan se Namuna.**

(a) Jab savdhan position se word of command milta hai, ginti se "Salami Shastr ek" to, is word of command par dahine hath se rifle ko sidha upar uchhalen aur baen hath se forehand guard aur dahine hath se small of the butt ko pakden aur shout karen 'ek'. Is position mein dekhne ki baten, baen hath fore hand guard par charon angulian bahar se aur angutha andar se pakra hua, charon angulian bahar se angutha andar se zameen ki taraf point karte hue, riflebadan ke dahini taraf 90 degree par. Baki position pahle ki tarah.

(b) Jab word of command milta hai "squad do" to, is word of command par dono hathon ki madad se rifle ko badan ke samne aur bich mein layen, sath hi baen hath ko chhor kar rifle ke baen bagal mein lagaen aur shout karen 'do'. Is position mein dekhne ki baten, rifle badan ke samne aur beech main 90 degree par khari magazine age, kohni se kalai tak rifle se mili hui, baen hath ki charon angulian aur angutha mila hua aur cooking handle kalme wali anguli aur anguthe ke bich, baki position savdhan.

(c) Jab word of command milta hai “squad teen” to, is word of command par dahine hath se rifle ko niche khinchen aur sidha Karen, baen hath se rifle ko samne se pakaren, dahina paon sidha sath hi chalti halat se, rifle ko samne se pakaren, dahina paon sidha sath hi chalti halat mein baen paon ki piche lagaen, shout karen ‘teen’. Is position mein dekhne ki baten, rifle baen haath se forehand guard se pakre hue, angutha baen taraf khara, dahina haath butt par, charon angulian aur angutha zameen ki taraf point karta hua, barrel nak se 6 inch dur, dahina paon baen paon ke piche chalti halat mein laga hua. Baki position savdhan.



“Ek” Pe Position



“Teen” Pe Position

BHAG II : SALAMI SHASTRA SE BAJU SHASTRA

7. **Zarurat.** Salami Shashtra se rifle ko niche lane ke liye Baju Shastr ki karyawahi ki jati hai.

8. **Bayan se Namuna.**

(a) Jab Salami Shastr se word of command milta hai, ginti se “Baju Shastr ek’ to, is word of command par dahine hath ko baen hath ke upar pakden aur dahine paon ko uthakar baen paon ke sath savdhan position mein lagaen aur shouting karen ‘ek’. Is position mein dekhne ki baten, rifle usi position mein, dahine hath se baen hath ke upar hand guard pakra hua. Baki position savdhan.

(b) Jab word of command “squad do” to, is word of command par dahine hath se rifle ko dahine le jaen aur baen hath ko chhorh kar flash hider se U shape mein pakaren, rifle zamin se 1 inch upar, dubara rifle ke hand guard se savdhan position ki tarah pakden, shout karen ‘do’. Is position mein dekhne ki baten, baen hath se flash hider U shape mein pakra hua, dhaine hath ki charon angulian bahar se angutha andar se, savdhaan position ki tarah pakra hua, rifle zamin se ek inch upar butt toe ke barabar.

(c) Jab word of command “squad teen” to is word of command par baen hath ko teji se savdhan position mein layen aur dahine hath se rifle ko zamin par savdhan position main layen, shout karen ‘teen’. Is position mein dekhne ki baten, position savdhan.

9. **Abhyas.** Ustad ke word of command pe squad isi kayawahi ka abhyas kare.

LESSON PLAN : AD 7
SQUAD DRILL

Period	-	One
Type	-	Practice
Code	-	AD 7
Term	-	II / III (SD/SW)

Trq Aid

1. Rifles.

Time Plan

2. (a) Khade Khade Squad Drill Abhyas - 20 Min
(b) Tez Chal se Squad Drill ka Abhyas - 20 Min

UDDESH

3. Is period mein Squad Drill ka Abhyas Karana hai.

TARTIB

4. Ustad squad ko kadwar sizing karke sabak ko do bhagon me chalayega:-
 - (a) Bhag I - Word of Command pe Rifle ke sath khade khade squad drill ka abhyas karana hai.
 - (b) Bhag II - Word of Command pe Rifle ke sath Tez Chal se squad drill ka abhyas karana hai.

LESSON PLAN : AD 8
NIRIKSHAN KE LIYE JANCH SHASTRA AUR BAJU SHASTRA

Period	-	One
Type	-	Lecture / Practice
Code	-	AD 6
Term	-	II (SD/SW)

Trq Aid

1. Rifles.

Time Plan

2. (a) Nirikshan ke liye Janch Shastra - 20 Min
- (b) Janch Shastra se Baju Shastra - 20 Min

UDDESH

3. Is period mein Nirikshan ke liye Janch Shastra aur Baju Shastra ki karyawahi sikhana hai.

TARTIB

4. Yeh sabak do bhagon mein chalaya jayega:-
 - (a) Bhag I - Nirikshan ke liye Janch Shastra.
 - (b) Bhag II - Janch Shastra se Baju Shastra.

BHAG I : NIRIKSHAN KE LIYE JANCH SHASTRA

5. **Zarurat.** Jab rifle ke saath duty ke dauran magazine aur chamber ko check karna ho us samay nirikshan ke liye jaanch shastr ki karyawahi ke jati hai aur kote mein rifle rakhne se pahle bhi nirikshan ke liye jaanch shastr ki karyawahi ki jati hai.

6. **Ginti aur Bayan se Namuna.**

(a) Jab savdhaan position se word of command milta hai ginti se "Nirikshan ke liye Jaanch Shastra ek" to, is word of command par rifle ko dahine hath se baen aur samne uchhalen aur dahine hath se pistol grip ko aur baen hath se forehand guard ko ek sath pakden. Is position mein dekhne ki baten, baen paon 12 inch baen taraf 4 inch age liye hue, dahine hath se pistol grip ko pakara huacharon angulian bahar se angutha andar se, baen hath se forehand guard ko pakda hu charon angulian niche se angutha upar se, barrel 45 degree par, rifle butt dahine thigh se laga hua. Baki position, vishram ki halat mein.

(b) Jab word of command milta hai "squad do" to, baen hath se cocking handle ko pakden. Is position mein dekhne ki baten, baen hath se cocking handle ko pakda hua, baki position pahle ki tarah.

(c) Jab word of command milta hai “squad teen” to, is word of command par baen hath se cocking handle ko piche khinchen aur holding opening catch lagaen. Is position mein dekhne ki baten, holding opening catch laga hua, baki position pahle ki tarah.

(d) Jab word of command milta hai “squad char” to, baen hath se cocking handle ko age karen. Is position mein dekhne ki baten, cocking handle ko age kiya hua, baki position pahle ki tarah.

(e) Jab word of command milta hai “squad panch” to, baen hath se fore hand guard ko pakden. Is position mein dekhne ki baten, No 1 ki tarah.

7. **Abhyas.** Ustad ke word of command pe squad isi kayawahi ka abhyas kare.

BHAG II : JANCH SHASTRA SE BAJU SHASTRA

8. **Zarurat.** Rifle ka nirikshan ho jane ke baad, rifle ko niche lane ke liye baju shastr ki karyawahi ki jati hai.

9. **Ginti aur Bayan se Namuna.**

(a) Nirikshan ke liye jaanch shastr se word of command milta hai ginti se “Baju Shastra ek” to is word of command par dahine hath ko fore hand guard par strike karen, sath hi baen paon ko savdhan position mein layen, shout karen ‘ek’. Rifle pahle ki position mein hi rahegi. Is position mein dekhne ki baten, dahine hath se forehand guard pakda hua. Baki position savdhan.

(b) Jab word of command milta hai “squad do” to, is word of command par dahine hath se rifle ko baju shastr No 2 halat mein niche layen aur baen hath se rifle ke flash hider par strike karte hue pakden, shout karen ‘do’. Is position mein dekhne ki baten. Baju shastr ke No 2 harkat ki tarah.

(c) Jab word of command milta hai “squad teen” to, is word of command par baen hath ko savdhan position mein le jaen aur dahine hath se rifle ko heel butt par sawar karen, shout karen ‘teen’. Is position mein dekhne ki baten, position savdhan.

10. **Abhyas.** Ustad ke word of command pe squad isi kayawahi ka abhyas kare.

LESSON PLAN : CD 1
GUARD MOUNTING

Period	-	One
Type	-	Lecture / Practice
Code	-	CD 1
Term	-	I / II / III (SD/SW)

Trq Aid

1. Rifles.

Time Plan

2. (a) Guard Mounting ka Tarika - 15 Min
- (b) Abhyas - 25 Min

UDDESH

3. Is period mein Guard Mounting ka Tarika sihkana hai.

TARTIB

4. Yeh sabak do bhagon mein chalaya jayega:-
 - (a) Bhag I - Guard Mounting ka Tarika.
 - (b) Bhag II - Abhyas.

BHAG I : GUARD MOUNTING KA TARIKA

5. **Zarurat.** Guard Mounting aam taur pe Quarter Guard ya ksi bhi authorized adhikari (general officer) ke awas pe ya, visit ke dauran ki jati hai.

6. **Bayan va Tarika.**

(a) Guard mounting ke liye 2+6 jawanon ki zarurat hoti hai. Is men 6 jawan aur guard commander aur guard ka 2IC hota hai. Guard mount hone ke liye hamesha, do ranks me 'fall in' hoti hai, jis men guard commander sabse dahine hota hai aur, guard 2IC agali rank ke sab se baen hota hai.

(b) Guard Mounting NCO guard ke samne 12 kadam pe hota hai. Who guard ko "fall in" karega aur inspect karega. Is ka tarika is parkar se hai:-

(i) Jab word of command milta hai 'Guard-Parade Par' to puri guard savdhan karegi, guard mounting ke sthan pe march karegi, tham kareke 'samne mud' karegi aur 'khuli line' karegi aur vishram karegi.

(ii) Jab word of command milta hai 'Guard Savdhan' to guard savdhan hogi.

(iii) Jab word of command milta hai 'Guard Dahine Saj' to guard commander dahine mud karega, 5 kadam march karega, tham aur piche mud karega. Phir pehele agli line ko saj karega, phir, pichli line ko saj karega aur word of command dega 'samne dekh' aur phir apni position pe wapis ajega.

(iv) Jab word of command milta hai 'Guard-Bagal Shasta', to guard bagal shastra ki karywahi karegi.

(v) Is ke bad guard mounting NCO, orderly officer (Nirikshin Adhikari) ko repoprt de ga 'guard nirikshan ke lie hazir hai' (orderly officer ka sthan guard mounting NCO se 6 kadam piche hota hai). Report de kar guard NCO, guard ke dahine, guard commander se 6 kadam ke fasile par march karke, samne mud kar ke khada hojaye ga.

(c) **Orderly Officer.** Orderly officer ab guard is tarike se ko nirikshan karega aur mount karega:-

(i) Word of command dega 'Guard-bazu-Shasta'. Guard baju shastra karegi aur savdhan men khadi hogi. Orderly officer ek ek kareke guard ka nirikshan karega – pehale agli line phir pichli line. Nirikshan ke bad orderly officer wapis apne sthan pe ajata hai.

(ii) Word of command dega 'Guard Nirikshan Ke lie Janch Shastra' to, guard 'Nirikshan Ke lie Janch Shasta' ki karyawahi karegi. Orderly officer ab ek ek kare ke hatiyar ka nirikshan karta hai, aur guard commander se shuru karat hai. Guard commander apne nirikshan ke bad 'fall out' karta hai, aur orderly officer ke sath baki guard ka nirikshan karwata hai. Niriksha ke bad, orderly officer wapis apne sthan pe jata hai aur guard cmmander ape sthan pe.

(iii) Word of command dega 'Guard-Bolt Chhalao' to, guard sikhe hue tarike se bolt ko dhire se age chod ti hai aur band karti hai.

(iv) Word of command dega 'Guard-Baju Shastra to', guard baju shastra ki karywahi karega.

(v) Word of command dega 'Number---Samne Ki line - stick orderly-stic orderly Line Tor' to niukt kiya hua stick orderly line tod ki karywahi karega aur guard mounting NCO ke dahine ja kar khada ho jaye ga.

(vi) Word of command dega 'Guard-Bagal Shastra, to guard Bagal Shastra ki karywahi karega.

(vii) Word of command dega 'Guard - Apne Duty ke Lie Dahine Se-Tez Chal' to guard march off karti hai, orderly officer ko 'dahine dekh' ki karyewahi karti hai aur phir purani guard se takeover ki karyewahi karti hai.

(d) **Guard Room Ki Karyewahi.** Sentry jab nai guard ko ate hue dekhta hai to, who purani guard ko "Turn Out" karta hai. Nai guard jab apne diye hue sthan pe khadi ho jati hai to, purana guard commander, apni guard ko nai guard ke samne, 15 kadam pe 'fall in' karta hai. Ab, purani guard, nai guard ko "salami shastra" deti hai aur nai guard bhi purani guard ko "salami shastra" karti hai. Is ke bad, dono guard ek ek karke, 'baju shastra' karke "aram se' karte hain. Is ke bad, nai guard ka sentry, purane guard ke sentry ko "relief" karta hai, jo purana guard 2IC karwata hai. Ab purani guard visarjan karti hai aur nai guard unko "salami shastra" deti hai aur purani guard, nai guard ke samne se gujarti hui, "dahine dekh" karti hai.

(e) **Sentries Ki Badli.** Guard commander, nai sentry ko, sentry post tak march karte hue le jaye ga. Bagair kisi word of command ke, naya sentry, purane sentry ke baen position lega aur samne mude ga. Ab guard commander, dono sentry ke samne 3 kadm pe khada ho ga aur sentry ko uski duties ke bare men batae ga. Iske bad gaurd commander word of command de ga “ Sentry Badli”, to purana sentry do kadam age chale ga, aur naya sentry do kadam dahine lega. Ab naya sentry apni post lega aur guard commander purane sentry ko word of command dega “ Puran sentry – Tez Chal” aur usko guard room men lejae ga. Ab naya sentry bagal shastra karega aur apne sthan pe ja ke khada ho jaye ga.

BHAG II : GUARD MOUNTING KA ABHYAS

7. **Abhyas.** Ustad ke word of command pe squad isi kayawahi ka abhyas kare.

LESSON PLAN : CD 2
GUARD OF HONOUR

Period	-	One
Type	-	Lecture / Practice
Code	-	CD 2
Term	-	II / III (SD/SW)

Trq Aid

1. Rifles.

Time Plan

2. (a) Guard of Honour ka Tarika - 15 Min
(b) Abhyas - 25 Min

UDDESH

3. Is period mein Guard of Honour dene ka tarika sihkana hai.

TARTIB

4. Yeh sabak do bhagon mein chalaya jayega:-
(a) Bhag I - Guard of Honour ka Tarika.
(b) Bhag II - Abhyas.

BHAG I : GUARD OF HONOUR KA TARIKA

5. **Zarurat.** NCC cadets dwara Guard of Honour nimn likhit adhikarion ko pradan ki jati hai jab woh kisi NCC camp ka visit karte hain ya phi raise mauke hon jahan pe uhh adhikari invite kiye gaye hon :

- (a) Rashtrapati, Up-Rashtrapati aur Pradhan Mantri.
- (b) Governors and Lt Governors.
- (c) Raksha Mantri aur Raksha Rajya Mantri.
- (d) States ke Mukhya Mantri.
- (e) Sena / Nau Sena / Vayu Sena Pramukh.
- (f) The Defence Secretary.
- (g) Command ka General Officer Commanding-in-Chief (Army Wing Ke liye)

- (h) Nau Sena Command ke Flag Officer Commanding-in-chief (Naval Wing units only).
- (j) Vayu Sena ke Air Officer Commanding-in-Chief (Air Wing Units only).
- (k) Sena/Nau Sena/Vayu Sena ke Up Parmukh.
- (l) The Dignitaries addressing the convocation of a University.
- (m) University ke Chancellor.
- (n) University ke Pro-Chancellor / Vice Chancellor as Chief guest.
- (o) Director General NCC.

6. **Bayan va Tarika.**

- (a) Guard do ranks men form up karegi, agli line aur pichli line men 4 kadam ka fasla hoga. Guard Officer aur Colour JCO, agli line se 2 kadam age aur centre men honge. Guard commander agli line se 8 kadam age hoga, cadet se cadet ka fasla 24 inch hoga.
- (b) Band, guard ke agli line ki sidh men uske dahine 7 kadam pe hoga.
- (c) Do stick orderly dias ke dahine aur baen khade honge, dias ke agle kinare se 2 kadam dahine aur baen.
- (c) Conducting adhikari, VIP ko receive karke, dias ke dahine aur 3 kadm piche khada hoga.

7. **Guard ki Nafri.** Guard of Honour ki nafri is prakar se hogi:-

- (a) **For President.** 150 rank and file, 3 divisions men.
- (b) **For Vice President and Prime Minister.** 100 rank and file, 2 division men.

8. **Salutes.**

- (a) **Rashtriya Salute.** Kewal Rashtrapati ya Governors ko apne rajya men..
- (b) **General Salute.** Major General aur uske upar ke rank ke adhikari.
- (c) **Salami Shastra.** To all VIPs.

9. **Inspection / Nirikshan.** Is ke liye tartib is prakar se hogi:-

- (a) VIP ke ane ke samay, guard savdhan men hogi.
- (b) VIP ke dias pe phucne par, guard, VIP ke aude ke mutabik, Rashtriya / General Salute ya Salami Shastra karegi aur fir Baju Shastra karegi.
- (c) Guard commander, age badh kar VIP ko report dega “ _____ Unit Samman Guard - Ap ke Nirikshan ke Lie Hazir Hai- Sriman (Srimati Ji)”. Salute kar ke guard commander VIP ka wait kare ga.

(d) VIP dias se utar ke guard ki taraf bade ga. Guard commander VIP ko escort kare ga aur us ke baen rahe ga. Band ke pahale jawan ki line men ate hi, guard commander VIP ke dahine aur unki line men ho jaye ga.

(e) Pilot - sirif President ke liye hi age chalen ge.

(f) Nirikshan ke dauran, sabhi ranks VIP ke taraf nazar milaen ge. Band nazar samne rakhe VIP ke sath sath , sabhi ke sir bhi harkat Karen ge. Nirikshan kahatam hote hi band band hojae ga, aur isi pe sabhi ranks age dekh ne lagen ge. Sirf agli line ka hi nirikshan hoga.

(g) Nirikshan ke bad, VIP ko wapis dias pe guard commander escort kare ga. Guard commander VIP ko salute karke apne sthan pe wapis a jaega. VIP ke jane ke bad guard ko "vishram" siya jae ga.

BHAG II : GUARD OF HONOUR KA ABHYAS

7. **Abhyas**. Ustad ke word of command pe squad isi kayawahi ka abhyas kare.

LESSON PLAN : CD 3
PL / COY DRILL

Period	-	One
Type	-	Lecture / Practice
Code	-	CD 3
Term	-	II / III (SD/SW)

Trq Aid

1. Rifles.

Time Plan

2. (a) PI Drill Abhyas - 20 Min
(b) Coy Drill ka Abhyas - 20 Min

UDDESH

3. Is period mein PI / Coy Drill ka Abhyas Karana hai.

TARTIB

4. Ustad squad ko kadwar sizing karke sabak ko do bhagon me chalayega:-
 - (a) Bhag I - Word of Command pe Rifle ke sath PI drill ka abhyas karana.
 - (b) Bhag II - Word of Command pe Rifle ke Coy drill karana.

LESSON PLAN : CD 4
INSTRUCTIONAL PRACTICE

Period	-	One
Type	-	Lecture / Practice
Code	-	CD 4
Term	-	III (SD/SW)

Trq Aid

1. Rifles.

Time Plan

2. (a) IP Ka Tarika - 10 Min
(b) IP ka Abhyas - 20 Min

UDDESH

3. Is period mein IP ka tarika sikhana hai.

TARTIB

4. Ustad byan ke sath IP ka namuna dega aur bad menis ka abhyas karaega.

INDEX**WEAPON TRAINING**

<u>Ser No</u>	<u>Lesson Code</u>	<u>Subject</u>	<u>Cat</u>	<u>Page No</u>
1.	WT 1	Characterstics of a Rifle and its Ammunition	SD/SW	98
2.	WT 2	Stripping, Assembling, Cleaning and Sight Setting of .22 Rifle	SD/SW	100
3.	WT 3	Stripping, Assembling, Care, and Cleaning of 7.62 SLR	SD/SW	102
4.	WT 4	Loading, Cocking and Unloading	SD/SW	107
5.	WT 5	Lying Position, Holding and Aiming	SD/SW	109
6.	WT 6	Trigger Control and Firing a Shot	SD/SW	112
7.	WT 7	Range Procedure and Safety Precautions	SD/SW	114
8.	WT 8	Theory of Group and Snap Shooting	SD/SW	118
9.	WT 9	Short Range Firing, Aiming, Alteration of Sight	SD/SW	120

LESSON PLAN : WT 1
CHARACTERISTICS OF .22 RIFLE AND ITS AMMUNITION

Period	-	One
Type	-	Lecture/Practice
Code	-	WT 1
Term	-	I (SD/SW)

Training Aids

- Charts, Pointer, Black board & Chalk.

Time Plan

- Introduction & Uddesh - 05 Min
 - .22 Rifle ki Viseshataen - 15 Min
 - .22 Rifle Ammunition ki Viseshataen - 15 Min
 - Conclusion - 05 Min

INTRODUCTION

- .22 rifle ek bahut hi achha sidha sadha hathiyar hai. Iska istemal NCC cadet ko firing me hone wali ghabrahat ko hatane ke liye istemal karte hain. Isliye iska istemal karne se pahle iske baare mein jankari honi chahiye taaki cadet iska sahi istemal kar saken.

UDDHESH

- .22 Rifle aur uske Ammunition ki Viseshataen ke bare mein jankari dena hai.

TARTIB

- Is sabak ko do bhagon mein chalaya jaega :-
 - Bhag I - .22 Rifle ki Viseshataen.
 - Bhag II - .22 Rifle Ammunition ki Viseshataen.

BHAG I : .22 RIFLE KI VISESHATAEN

- .22 Rifle do kisim ki hoti hain. Rifle .22 No II MK IV aur .22 Deluxe BA. In ki viseshataen is parkar se hain:-

<u>Ser No</u>	<u>Details</u>	<u>Rifle .22 No II MK IV BA</u>	<u>Rifle .22 Deluxe BA</u>
(a)	Length	45"	43"
(b)	Weight	8 Lbs 10 ½ OZ	6 Lbs 2 OZ
(c)	Magzine Capacity	10 Rounds	05 Rounds

(d)	Muzzle Velocity	2700' per sec	2700' per sec
(e)	Grooves in the barrel	06	06
(f)	Effective Range	25 yds	25 yds
(g)	Max Range	1700 yds at 33 angle	1700 yds at 33 angle
(h)	Calibre	.22	.22
(j)	Ammunition	.22	.22
(k)	Rate of fire :- (i) Normal (ii) Rapid	05 Rds pm 10-15 Rds pm	05 Rds pm 10-15 Rds pm



Rifle . 22 MK IV



Rifle . 22 Deluxe BA

BHAG I : .22 AMMUNITION KI VISESHTAEN

7. **.22 Ammunition.**

- | | | | |
|-----|----------------------------|---|---------------|
| (a) | Calibre | - | .22 |
| (b) | Length of Bullet | - | 10 mm |
| (c) | Length of Bullet with Case | - | 15 mm |
| (d) | Weight | - | 38/40 gm |
| (e) | Type of Bullet | - | Lead / Copper |
| (f) | Type of Ammunition | - | Rim / Rimless |

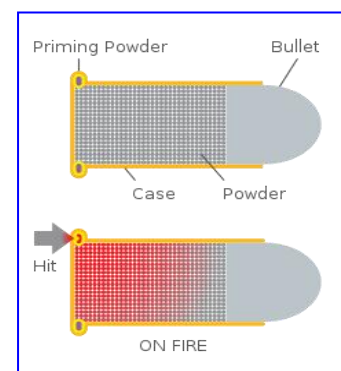

SANKSHEP

8. .22 rifle ek bahut hi kargar aur sidha sadha hathiyar hai jis ki madad se cadet ko durust fire karne ka tarika sikhaya jata hai. Iss hathiyaar ki achhi jankari hone se cadets ko achha firer banaya ja sakta hai.

LESSON PLAN : WT 2
STRIPPING, ASSEMBLING, CLEANING
AND SIGHT SETTING OF .22 RIFLE

Period	-	One
Type	-	Lecture/Practice
Code	-	WT 2
Term	-	I (SD/SW)

Training Aids

1. Charts, .22 Rifle, Case Collector, Chindi, Pull Through, Ground Sheet and Oil Bottle.

Time Plan

2.	(a)	Introduction	-	03 Min
	(b)	.22 Rifle Kholna aur Jorna	-	10 Min
	(c)	Safai Karne ka Tarika	-	10 Min
	(d)	Abhyas	-	15 Min
	(e)	Sankshep	-	02 Min

INTRODUCTION

3. .22 rifle ek bahut hi achcha sidha sadha hathiyar hai. Iska istemal NCC cadet ko firing me hone wali ghabrahat ko hatane ke liye istamal karte hain. Isliye iska istemal karne se pahle iske baare mein jaankari honi chahiye, taaki cadet iska, kholna jorna aur safai kar saken.

UDDHESH

4. .22 Rifle ka Kholna-Jorna, Sight Setting aur Safai karne ka tarika sikhana hai.

TARTIB

5. Is sabak ko do bhagon mein chalaya jaega :-
 - (a) Bhag I - .22 Rifle Kholna -Jorna.
 - (b) Bhag II - .22 Rifle ka Safai Karne ka Tarika

BHAG I : RIFLE .22 KO KHOLNA – JORNA AUR SIGHT SETTING

7. **Kholna.** Rifle ko kholne ki tarkib main sabse pahle bayonet, phir sling, bolt aur case collector ko khola jata hai. Sling ko utaren aur roll karte hue ground sheet par rakh den. Safety catch 'S' par Karen, bolt lever ko upar ki taraf uthate hue bolt ko piche ki taraf khichein aur rifle se alag karen. Aakhir mein case collector catch ko dabate huye case collector ko alag karen aur saaf jagah pe rakhen.

8. **Jorna.** Yakin Karen safety catch 'R' par hai. Bolt ko uthaen aur bolt head ko tight karen. Uske baad bolt ko guide ke saath milate hue fit karein. Jorte samay yadi ek se jyada rifle khula hai to uske purjon ke registration no. check karlen. Trigger dabaen, safety catch ki position 'S' par Karen aur case collector ka chota mehrav aage ki ore rakhte hue use fit karen. Sling ko rifle mein fit Karen. Bayonet sabse baad mein fit Karen.

9. **Sight Setting.** Sight set karne ke liye thumb spring ko press karo aur sight ko set karo. Muzzle ki taraf le jane se range badhti hai.

BHAG II : SAFAI KARNE KA TARIKA

10. .22 rifle ko bhi Anaya hathiyar ki taraha Safaai kiya jata hai.

(a) **Aam Safai.**

(i) **Daily Safai.** Aam taur par daily hathiyar training ke liye nikalte hain. Hathiyar ka dusting karke Kote mein jama karte hain.

(ii) **Weekly Safai.** Saptah me ek bar hathiyar ko bahar nikala jata hai aur sabhi hisse purjon mein oil badly kiya jata hain.

(iii) **Quarterly Safai.**

(aa) Quarterly ke douran pure hathiyar ko khola jata hai aur jaruri suda hathiyar oil aur greasing kiya jata hai.

(ab) Hathiyar ke hisse purjon ki tut- phut check ki jaati hai aur unhe marammat kiya jata hai.

(b) **Firing Ke Dauran Safai.**

(i) Firing se pahle hathiyar ki tut phut ko armourer dwara check karate hain.

(ii) Lagaatar hathiyar ki safai karte hain aur armourer dwara inspection karate hain.

(iii) Firing ke dauran jab bhi firer ko mauka milta hai to wah apne hathiyar ko saaf karta rehta hai.

(c) **Firing Ke Baad Ki Safai.**

(i) Firing ke baad firer kam se kam 07 din garm pani dalkar barrel ko saaf karte hain.

(ii) Uske baad armourer dwara inspection karaya jata hai.

Note: Safai ke liye Chindhi ka size 4x1.5" aur Oil ke saath chindi size 4x 1".

11. **Abhyas.** Squad ko groupon mein baanto aur .22 rifle ko kholne aur jorne ke tarike ka abhyas class ko karwao.

SANKSHEP

12. .22 rifle ek bahut hi kargar aur sidha sadha hathiyar hai jis ki madad se cadet ko durust fire karne ka tarika sikhaya jata hai. Iss hathiyaar ki achhi jankari hone se cadets ko achha firer banaya ja sakta hai.

LESSON PLAN : WT 3
STRIPPING, ASSEMBLING AND CLEANING
OF 7.62 MM SLR

Period	-	One
Type	-	Lecture/Practice
Code	-	WT 3
Term	-	I (SD/SW)

Training Aids

1. 7.62 mm SLR, Magazine, Charts, Pullthrough, Chindi, Black board, Target 1x1, Sand Bag, Ground Sheet, Oil Bottle, Graphite Grease Tube, Body Brush, Chamber Brush and Combination Tool.

Time Plan

2.	(a)	Introduction & Uddesh	-	03 Min
	(b)	Aam Bayan aur Visheshtayen	-	07 Min
	(c)	Kholna-Jorna aur Safai Karna	-	14 Min
	(d)	Abhyas	-	14 Min
	(e)	Sankshep	-	02 Min

INTRODUCTION

3. 7.62 mm SLR Sena mein lambe arse tak raha hai. NCC mein isko sena se phase out karne ke baad laya gaya hai. Taki iss caliber ke hathiyar ki handling cadet ko sikhai ja sake Isliye, iss ka aam bayan, Visheshtayein, kholna, jorna, aur safai karne ka tarika aana chahiye, taki jarurat padne par har cadet teji aur durusti se karywai kar apna muddha hasil kar sake.

UDDESH

4. 7.62 mm SLR ka Aam Bayan, Visheshtayein, Kholna, Jorna aur Safai karne ka tarika sikhana hai.

TARTIB

5. Ye sabak teen bhagon mein chalaya jayega:-

- | | | | |
|-----|----------|---|--|
| (a) | Bhag I | - | 7.62 mm SLR ka Aam Bayan aur Visheshtayen. |
| (b) | Bhag II | - | 7.62 mm SLR Kholna-Jorna aur Safai karna. |
| (c) | Bhag III | - | Abhyas. |

BHAG I : 7.62MM SLR KA AAM BAYAN AUR VISHESHTAYEN**Aam Byan**

6. (a) Self Loading hai – fire hone ke bad, agli goli chamber men load apne aap ho jati hai.
- (b) Kargar Range Jida hai.
- (c) Safai karna asaan hai.
- (d) Magazine capacity 20 rounds hai.
- (e) Iski applied safety - safety catch aur mech safety - lock aur unlock hai.
- (f) Yeh ek gas se kaam karne wala hathiyar hai.

**7.62 mm SLR Ki Visheshtayen**

7. **Calibre (Kuttar)** - 7.62 mm.
8. **Length.**
- (a) Short butt ke saath - 1126.50mm (44.35in).
- (b) Normal butt ke saath - 1139.20mm (44.85 in).
- (c) Long butt ke saath - 1151.90mm (45.35in).
- (d) Rifle aur bayonet ke saath - 1397.00mm (55 in).
9. **Weight.**
- (a) Rifle only - 4.4 kg.
- (b) Rifle aur full mag ke saath - 5.1 kg.
- (c) Rifle, full mag, bayonet ke saath - 5.392 kg.
- (d) Bayonet - 0.283 kg.
- (e) Khali Mag - 0.255 kg.
- (f) Bhari hui Mag - 0.709 kg.
10. **Rate of Fire.**
- (a) Normal - 5 rds per min.
- (b) Rapid - 20 rds per min.
- (c) Faster than rapid - 60 rds per min.

11. **Range.**
- (a) Effective range - 275 m (300 yds).
- (b) Sight range - 200 yds to 600 yds.
12. Sight Radius - 533.40 mm (21.77in).
13. Grooves ki tadat - 06 (Six).
14. Pitch - 1 turn in 304.8mm (12 in).
15. Rifling ki Twist - Right Hand ki taraf.
16. System of Operation - Gas Operation.
17. Full Mag ki Capacity - 20 rds.
18. **Amn 7.62mm Ki Visheshtayen.**
- (a) Calibre - 7.62 mm.
- (b) Cart ka wajan - 23.07gm \pm 0.65 gm.
- (c) Cart ki lambai - 71.16mm \pm .76mm (2.80-0.03 in).
- (d) Bullet ka wajan - 9.33 \pm 0.13 gm (144 \pm 2 gm).
- (e) Powder charge - NC Powder.
- (f) Muzzle velocity - 815m/2700ft \pm 30 ft/S.
- (g) Khali cart case ka wajan - 10.89 gm.
- (h) Propellant charge ka wajan - 2.85 gm.



BHAG II : RIFLE KO KHOLNA-JORNA AUR SAFAI

Kholna

19. **Rifle ko Kholna aur Jorna.** (Ustaad bayaan ke saath namuna den) Yakin karen ki Rifle khali hai, safety catch ko 'S' par karen aur magazine ko utaro, Rifle ko cock karo. Dhyan rahe Rifle ko bina cock kiye na khola jaye, agar bina cock kiye Rifle ko kholte hain to hammer plunger gir sakta hai. Agar aisa ho jata hai to hammer plunger ko jorne ke liye hammer ko saaf karen. Plunger ka patla bhag hammer ki jhirrion mein tikao aur hammer spring ko thoda dabate hue plunger ke pichle hisse mein baitha dein.

20. **Gas Plug aur Piston.** Ball ammunition fire karne ke liye gas plug ka kata hua bhag upar ki taraf hota hai. Jisko kholne ke liye gas plug par dabao rakhte hue combination tool ki madad se ghadi ki suion ke rukh ghumao taki gas plug block se alag ho jaye. Jab rifle se grenade fire karte hain us halat mein gas plug mein kata wala bhag barrel ki taraf rahata hai. Gas plug ko kholne ke liye, gas plug pe kabu pate hue ghadi ki suiyan ke ulte rukh mein combination tool ki madad se ghumao, gas plug apne block se alag ho jayega. Gas plug ko saaf jagah par rakho, piston ko nikale aur spring alag karen.

21. **Slide aur Breach Block ko Kholna.**

(a) Bayen haath se hand guard ko pakade, muzzle niche ke taraf rakhte hue, dayen haath ki madad se body locking catch ko piche ki taraf khinchte hue butt ko niche ki taraf dabaye. Rifle asani se khulegi.



(b) Return spring ki madad se chal wale purjon ko piche khicho, niche girne se bachane ke liye niche ungliyan rakho.

22. **Firing Pin aur Extractor ko Khonla.**

(a) Firing pin ko piche se dabao aur pin firing axis ko kisi nukuli cheez se bayen se dabakar pin firing par kabu rakhte hue bahar nikalo.

(b) Extractor ko kholne ke liye tool removing extractor ki madad lo.

Jorna

23. Jo purje sabse akhir mein khola jaye, use jorne mein sabse pahale jora jaye. Purjon ko jorte samay register number milana jaroori hai.

24. **Extractor ko Jorna.** Ise jorne ke liye breach block ko pakro, plunger ko combination tool ki madad se pura pichen ki taraf khinche, spring aur extractor ko khacnhe me baitha do, iske baad plunger ka dabao dhire-dhire hata lein. Yakin karen ki extractor thik tarah jud gaya hai.

25. **Firing Pin ko Jorna.** Firing pin ke sath spring ko fit karen. Yakin karen ki firing pin retainer ka kata bhag uppar ki taraf ho. Firing pin ko andar ki taraf dabayen aur axis pin ko dayen se baayen fit karen.

26. **Breach Block aur Slide ko Jorna.** Bayen haath se slide ko ulta pakden aur breach block len. Breach block retainer ko slide ke baayen katav me dalen aur aage ki taraf dabayen. Jure hue slide aur breach block ko len aur dahine haath ko pakden. Baayen haath se rifle ko pakden aur slide ke races ko body ke katav mein milaen aur andar dakhil karen, saath hi body cover ko fit karen aur rifle ko ek hi jhatke mein band karen.

27. **Piston aur Gas Plug ko Jorna.** Piston spring ko piston ke ubhre hue bhag par chadhayen aur cylinder mein dakhil karen. Gas plug ko lein aur block mein fit karen, plunger par dabao rakhte hue ghadi ke ulte rukh ghumaye taki gas plug ka kata hissa upar ki taraf aajaye. Saath hi plunger se dabao hata lein, yakin karen ki gas plunger thik se jur gaya hai.

28. **Bayonet, Sling aur Magazine ko Chadhana.** Bayonet ko muzzle par iss prakar rakhen ki bayonet muzzle par thik se baith jaye. Ab bayonet stud ko dabate huye bayonet ko niche dabaye, bayonet jur jayega. Magazine ko fit karne se pahale Rifle ko cock karen, safety catch ki position 'S' se 'R' par karte huye trigger ko dabayen. Iske baad khali magazine ko chada dein.

Safai Karne Ka Tarika

29. Safai karne ki liye nimn likhit samaan ki jarurat padti hai.

- (a) Oil bottle.
- (b) Brush cleaning bore.
- (c) Brush cleanig chamber.

- (d) Pull through.
- (e) Rod cleaning barrel.
- (f) Tool Removing ruptured case.

30. Ye jaruri hai ki rifle ko thik tarah se safai ke sath rakha jae aur theek se tel lagaya jae, taki bina rukawat se rifle ko aasani se fire kiya ja sake. SLR ki safai bhi aam hathiyar ki taraha nimna likhit maukon par pahale sikhlae ja chuke dhang se hoti hai.

- (a) **Rojana Ki Safai**. Yekin kare rifle khali hai use sikhe tarike se khol de, purjon ko chindi aur pull through ki madad se saaf kare:-
 - (i) Barrel Pull through (Dry) 10 X 5 cm.
 - (ii) Oil (Tel) 10 X 3.75 cm.
 - (iii) Cylinder Pull through 10 X 5 cm.
- (b) Weekly Safai.
- (c) Monthly Safai.
- (d) Firing se Pahale ki Safai.
- (e) Firing ke Dauran ki Safai.
- (f) Firing ke Baad ki Safai.
- (g) Namidar ilake men Safai.

31. **Lubrication**. Alag-Alag ilake ke temperature ko dhayan men rakhte hue lubrication oil ka istemal hota hai :-

- (a) 4 degree se above - OX-52.
- (b) 4 Degree se - 18 Degree Tak - OX-13.
- (c) -18 Degree se - 40 Degree - OX 13 + super K/Oil- 1:1.
- (d) -40 degree se -50 degree - OX 13 + super K/Oil- 2:3.

BHAG III : ABHYAS

32. Class ko jodi-jodi men rifle ko kholne – jorne ka abhyas karao.

SANKSHEP

33. 7.62 mm SLR ek bharose mand hathiyar hai par iski maintenance aur achhi handling ke liye jaruri hai ki cadet ko is hathiyar ka kholna jorna aata ho. Saath hi iss hathiyar ki kabliyat janana bhi jaroori hai taaki yathochit udeshya ki purti main iska upyog.

LESSON PLAN : WT 4
LOADING, COCKING AND UNLOADING OF .22 RIFLE

Period	-	One
Type	-	Lecture/Practice
Code	-	WT 4
Term	-	I (SD/SW)

Training Aids

1. .22 mm rifle, Magazine, Dummy Rds, Charts, Target 1X1, Sand Bag, Ground Sheet.

Time Plan

2.	(a)	Introduction & Uddesh	-	03 Min
	(b)	Bharna, Cock Karna aur Khali Karna	-	10 Min
	(c)	Abhyas	-	20 Min
	(d)	Sankshep	-	02 Min

INTRODUCTION

3. Ek acche firer ki khubi hoti hai ki who tezi se rifle ko bhare, load kare aur durust fire kare. Yeh tabhi sambhav ho sakta hai jab training ke dauran acchi sikhlai aur abhyas Karen.

UDDESH

4. .22 Rifle ko bharna, cock karna aur khali karne ka tariqa sikhana hai.

TARTIB

5. Ye sabak do bhagon mein chalaya jayega:-

- (a) Bhag I - .22 rifle ko Bharna, Cock Karna aur Khali Karne ka Byan / Namuna.
- (b) Bhag II - Abhyas.

**BHAG I : .22 RIFLE KO BHARNA, COCK KARNA AUR
 KHALI KARNE KA BYAN / NAMUNA**

6. **Rifle ko Bharne ki Karwahi.** .22 Deluxe Rifle ke sath koi charger nahi diya jata hai. Ammunition ko siddha mag men ek ek kar ke bhara jata hai. Bharne se pehle ammunition ko saaf kar len.

7. **Loading, Cocking aur Unloading.**

- (a) Loading, cocking aur unloading ki karwahi hamesha hokum pe hi ki jati hai. Karwahi hamesha tezi se aur sahi tartib se hi ki jati hai.

(b) Is karwahi ko let ke karne ke liye drill is parkar se hai:-

(i) Let ne ke liye, bayen paer se ek lamba kadam len, rifle ko bayen hanth men pakren, phir dahina hanth zamin pe rakhen, bayen paer ki line men aur let jaen. Let te sayam, dono tange khuli honi chahiye. Ab rifle ke bolt ko piche khinch ke, age push karo taki round chamber men load ho jaye.

(ii) Unload karne ke liye, bolt ko piche kincho, taki fire kiya hua round bahar nikal jaye.

BHAG II : ABHYAS

8. Class ko jodi-jodi men loading, cocking aur unloading ka abhyas karao.

SANKSHEP

9. Drust tartib se rifle ko load karna, cock karna aur unload karna ek ache firer ki khubi hai, jo sabhi ko abhyas karke hasil karni chahiye.

LESSON PLAN : WT 5
LYING POSITION, HOLDING AND AIMING OF .22 RIFLE

Period	-	One
Type	-	Lecture/Practice
Code	-	WT 5
Term	-	I / II / III (SD/SW)

Training Aids

1. .22 mm rifle, Magazine, Dummy Rds, Charts, Target 1X1, Sand Bag, Ground Sheet.

Time Plan

2.	(a)	Introduction & Uddesh	-	03 Min
	(b)	Lying Position, Holding aur Aiming	-	10 Min
	(c)	Abhyas	-	20 Min
	(d)	Sankshep	-	02 Min

INTRODUCTION

3. Rifle se kai position se fire kiya jata hai lekin, position aisi honi chahiye ki aasani se ikhitar kiya ja sake aur hathiyar par majboot pakar hasil ki ja sake. Yeh zamin ki banawat aur kudrati sidhai par nirbhar karta hai. Isliye har ek cadet ko kudrati sidhai hasil karne ka tariqa pata hona chahiye. Yeh tabhi sambhav ho sakta hai jab ek cadet squad post training ke dauran achchi sikhlai paya ho.

UDDESH

4. .22 Rifle ka Lying Position, Holding aur Aiming ka Trika Sikhana hai.

TARTIB

5. Ye sabak do bhagon mein chalaya jayega :-

- | | | | |
|-----|---------|---|---|
| (a) | Bhag I | - | Lying Position, Holding aur Aiming ka Byan va Namuna. |
| (b) | Bhag II | - | Abhyas. |

BHAG I : LYING POSITION, HOLDING AUR
AIMING KA BYAN VA NAMUNA

6. **Lying Position.** Lying position asani se akhtiyar ki jane wali aramdeh aur bunyadi position hai. Iss position mein badan ka khaka chhota banta hai, jis se larai ke maidan mein nichhi se nichhi aar ke piche se dushman ki najar aur fire se bachte hue dushman ke upar kargar fire dal sakte hai.

7. **Position Lene Ka Tarika.** Sabse pehle target ki sidh mein khare ho jaen, chalti halat mein baen paon ko thora baen aur age len, sath hi rifle ko baen hath men pakren. Iske bad daen hath se zamin ka sahara lete hue, let jaen. Rifle ko dahine rakhen aur bayen haath ki kohni ko tab tak harkat den jab tak ki target, baen kohni, dahina kandha aur dahina paon ek seedh mein na aa jae. Ab dahini kohni ko us jagah par rakhen jahan par kohni dahine aur thora kandhe ke niche ho. Dono haathon ki hatheli ko thudi ke neeche lagakar aankhen band Karen aur badan ke tanav ko mahsoos Karen, yadi badan mein tanav hai to kohni usi jagah rakhte hue badan ko aage peechhe karte hue tanav ko door Karen aur kohni ki jagah ko mark kar den.

8. **Holding (Durust Pakar).** Rifle ki pakar haasil karne ke liye kandhe mein le jaen. Baen haath ki kalmen wali anguli aur anguthe ke beech jo 'V' banta hai wahan par rifle ko rakhen. Hand guard niche wali hatheli ke upar aa jae. Charon angulian bahar se aur angutha andar se saath hi magazine ko kalai ke saath hona chahiye. Poori pakar ko majboot karne ke liye baen kohni ke loose mans ko zamin par jamate hue thora aage push Karen , dahine kohni ke loose mans ko kaabu rakhne ke liye kohni ko apni taraf khiche. Yadi rifle upar point kar rahi ho to dahine hath ko aage Karen. Agar niche point kar rahi ho to dahine hath ko piche Karen. Agar baen point kar rahi ho to dahine pair ko baen kare. Agar dahine point kar rahi ho to position thora dahine Karen. Khara hone ke



9. **Aiming (Sisht) Lene ka Kaida.** Let ke firing position ko ikhtihar karen, rifle ko seedha aur majboot pakren. Target ka khaka apne dimag mein bithayena aur koi ek aankh band karen. Rear sight aperture ke beechon beech fore sight tip ki noke ko POA par milaen aur durust sight picture haasil karein. Trigger press karne se pahle nazar fore sight ki tip par layen. Sisht main do mukhya baaten taluk rakhti hain.

(a) **Sight Alignment.** Jab ek firer back sight aperture ke madhya mein fore sight tip ko milata hai ,yani ki firer ki aankh, back sight aperture ka madhya aur fore sight tip ko ek line mein milane ki karwahi ko sight alignment kahte hain.

(b) **Sight Picture.** Durust align ki gai sight ko POA par milane ke karwahi ko sight picture kahte hain, yani ki firer ki aankh, back sight aperture ka Madhya fore sight tip aur POA tak jo farziya line banti hai use sight picture kahte hain.

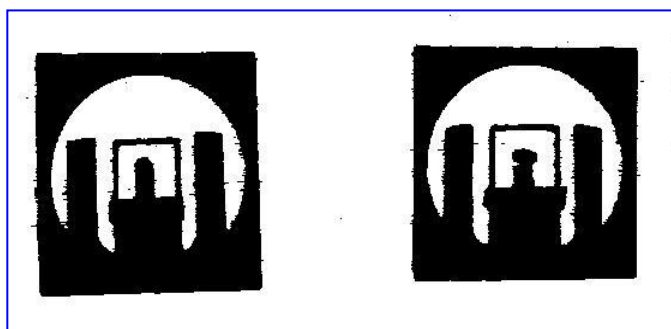

Durust Sisht

BHAG II : ABHYAS

10. Class ko jodi-jodi men lying position, holding aur aiming ka abhyas karao.

SANKSHEP

11. Drust firing tabhi mumkin hai, jab ek firer durust position, majboot pakar, durust sisht aur durust trigger operation karta hai. Is ke liye kafi abhyas karna padta hai.

LESSON PLAN : WT 6
TRIGGER CONTROL AND FIRING A SHOT

Period	-	One
Type	-	Lecture/Practice
Code	-	WT 6
Term	-	I / II / III (SD/SW)

Training Aids

1. .22 mm rifle, Magazine, Dummy Rds, Charts, Target 1X1, Sand Bag, Ground Sheet, Aim Correcter and Tin Disc.

Time Plan

2.	(a)	Introduction & Uddesh	-	03 Min
	(b)	Durust Trigger Control aur Fire	-	15 Min
	(c)	Abhyas	-	15 Min
	(d)	Sankshep	-	02 Min

INTRODUCTION

3. Ahook nishane baaji ke buniyadi usool hain majbot pakar, durust sisht lena, aur durust trigger operation ki karwahi. Is liye har ek firer ko sisht lene ke saath –saath sahi trigger operation ki karwahi achhi tarah se aani chahiye.

UDDESH

4. .22 Rifle ka sahi Trigger Control aur Firing ka tqrika sikhana hai.

TARTIB

5. Ye sabak do bhagon mein chalaya jayega :-

- (a) Bhag I - Durust Trigger Control aur Fire ka Byan va Namuna.
- (b) Bhag II - Abhyas.

BHAG I : DURUST TRIGGER CONTROL AUR FIRE

6. **Trigger Control.** Durust trigger control ke liye tartib is parkar se hai :-

- (a) Durust trigger operation ke liye kalmi wali anguli (index finger) ka sahi istemal hai. Anguli ka pehla aur dusre jor ke beech ki jagah ko trigger ke upar rakhte hai.
- (b) Trigger ke do khichav hai, halka aur sakht khichav. Pahla khichav haasil karne ke baad dusra khichav hasil karen. Trigger dabate samay barrel harkat nahin karni chahiye.

(c) Sahi trigger operation ki karwai karne ke liye firer ko tin disk ex di jati hai. Is men rif ko ready karo aur barrel par tin disk rakho aur trigger ko press karo. Agar tin disk niche nahin girti hai to trigger operation ki karwahi sahi hai.

7. **Shot Fire Karne ki Tartib.** Sahi shot fire karne ke liye sahi position aur pakar, sahi eyesight, aiming, dimag aur trigger control men durust tal-mel se hi hasil ho sakta hai. Is ke liye tartib is parkar se hai :-

(a) Sahi posn ikhtiyar karen. Kudrati seedhai ko check karen.

(b) Rif ko bhar karen, Ready karen, sahi sight lagaen aur sahi alignment hasil karen. Dimagi taur par un angon ko check karen jo rifle ko hold karne mein madad karte hain. Jaise baen hath ki kohni, kalai, dahina kandha, dahine haath ki pakar aur kalme wali anguli.

(c) Ab saans ko normal chalne den aur, back sight aperture ka madhya se fore sight tip ko POA se milao. Fore sight tip 6 baje aur 12 baje ki line mein harkat karni chahiye.

(d) Trigger ka pahla khichav haasil karne ke baad kuchh samay ke liye saans ko roken. Aur sight picture ko check karen. Uske baad poora dhyan fore sight tip par le jaen aur trigger dabayen to goli fire ho jaegi.

(e) Goli fire ho jaane ke baad usi pakar, posn aur sisht ko kayam rakhte hue fore sight tip ki movement ko check karen fore sight ki tip jahan point karegi goli usi jagah par lagegi.

(f) Ab saans ko chhor den aur 'maar' ko pukaren. Goli fire hone se maar pukarane tak ki karwai ko **follow through** kahte hain.

BHAG II : ABHYAS

8. Class ko jodi-jodi men trigger control aur fire ka abhyas karao.

SANKSHEP

9. Drust firing tabhi mumkin hai, jab ek firer durust position, majboot pakar, durust sisht aur durust trigger operation karta hai. Is ke liye kafi abhyas karna padta hai.

LESSON PLAN : WT 7
RANGE PROCEDURE AND SAFETY PRECAUTIONS

Period	-	One
Type	-	Lecture/Demo/Practice
Code	-	WT 7
Term	-	I / II / III (SD/SW)

Training Aids

1. Red flag 6'x6', Flag pole 20', Target Plate 3'x 2', Red Jacket, Helmets, Repairing Material, Butt Register, Sand Bag and Ground Sheet.

Time Plan

2.	(a)	Introduction & Uddesh	-	03 Min
	(b)	Range ki Tartib aur Fire	-	15 Min
	(c)	Demo	-	15 Min
	(d)	Sankshep	-	02 Min

INTRODUCTION

3. Shooting ke darje banaye rakhne ke lie, troops range par pistol, carbine rifle aur lmg fire mein abhyas karte hain. hamare desh mein short range to takriban har unit mein paaye jaate hain lekin classification range bahut kam jagah par hote hain. range allotment ka pura faide uthane ke lie fire se pahle samay se range fire ke lie tayar karna aur range par durust range drill par amal karne se sabhi trainees ko fire mein abhyas diya ja sakta hai.

UDDESH

4. Is lecture aur demonstration ka uddesh, range par durust Range ki Tartib aur Fire conduct karne ka tarika sikhana hai.

TARTIB

5. Is lec aur demonstration ko teen bhagon mein chalaya jaega :-
- | | | | |
|-----|----------|---|--|
| (a) | Bhag I | - | Fire se pahle ki taiyariyan aur zaruri saman. |
| (b) | Bhag II | - | Practice conduct karna aur suraksha sambandhi baatein. |
| (c) | Bhag III | - | Demonstration. |

BHAG I : FIRE SE PAHLE KI TAIYARIYAN AUR ZARURI BAATEIN

6. **Fire Se Pahle Ki Taiyariyan.** Range per, range standing orders, pamphlet Inf training vol I aur range course ke mutabiq fire ke lie tayar karna chahiye taaki, fire samay par shuru kiya ja sake aur fire ke dauran koi hadsa na ho. Range ki taiyari mein nimnlkhit baatein shamil ki jaen:-

- (a) Stop butt ke dahine kinare par 20' uncha staff pole jis par 6x6' ka lal jhanda laga ho.
- (b) Stop butt ki mitti naram aur usmen pathar ya sikka na ho.
- (c) Target bahar wale kinare se 20' andar ki taraf ho.
- (d) Stop butt par 2'x3' chauri target number plate lagi ho.
- (e) Markers gallery ke bayen taraf 12' pole par 4x5' ka lal jhanda laga ho.
- (f) Mantlet butt ki mitti naram aur usmen bhi koi pathar ya sikka na ho.
- (g) Firing point aur trenches par format ke mutabik naram mitti se bhara sand bag ho.
- (h) Area saaf ho.
- (i) Range ke ek taraf munasib jagah par nimnlkhith stand lagaye jaen.
 - (aa) Ammunition.
 - (ab) Armour.
 - (ac) Nursing Assistant.
 - (ad) Sights kala karne ki jagah.
- (j) Milap ke liye telephone line lay kiya hua sath hi radio set ka bandobast.
- (k) Sentries, nafri aur jagah range standing order ke mutabik, lal coat men ho.

7. **Anya Taiyariyan.**

- (a) Range clearance.
- (b) Firers ka nominal roll taiyar karna.
- (c) Hathiyaron ki before firing inspection.
- (d) Ammunition ka bandobast.
- (e) Milap ke sadhan ka prabandh.
- (f) Butt party bantna.
- (g) Working party bantna.
- (h) Coaches ka bandobast.
- (j) Hathiyar safai ke lie saman.
- (k) Warning boards taiyar karna.
- (l) Armourer, Nursing Assistant aur bugler ka saman ke sath bandobast.
- (m) Practice ke mutabik target taiyar karna.

- (n) Temporary camp lagane ka bandobast yadi range unit se dur ho.
- (o) **Documents.**
 - (i) Firing point register.
 - (ii) Butt register.
 - (iii) Range course SAO 12/S/85 (new RANGE course).
 - (iv) No damage certificate.
 - (v) Lead deposit certificate.
 - (vi) Ammunition aur fired case ka detail

BHAG II : PRACTICE CONDUCT KARNA AUR SURAKSHA SAMBANDHI BAATEIN

Practice Conduct Karna

- 8. Range par firer ko 2 groups mein baant diya jata hai, Firing Group aur Training Group.
- 9. **Firing Group.** Pure firers ko details mein bant diya jata hai aur ek samay par chaar (4) detail range par kaam kar rahi hoti hain yani ki.
 - (a) Firing Detail.
 - (b) Waiting detail – do (2).
 - (c) Ammunition collection detail.
- 10. **Target Group.** Firing point se piche target group ko nimnikhit abhyas ke lie lagaya jata hai.
 - (a) Aiming.
 - (b) Trigger operation.
 - (c) Holding.
 - (d) Roken dur karna.
 - (e) Firers ki jati galti ke lie sudhara exercise aur coaching.
 - (f) TsOET.

Suraksha Sambandhi Baatein

- 11. **Firing Point se Phele.**
 - (a) Hathiyar clear, magazine utra hua aur safety device laga hua.
 - (b) Muzzle hamesha surakshit disha mein.
 - (c) Drill cartridge ka istemal nahin.
 - (d) Ammunition practice ke mutabik issue.
 - (e) Harkat chal kar.
 - (f) Chamber hamesha khali.
 - (g) Dry exercise se pahle hathiyar ka nirikshan.
- 12. **Firing Point Par.**
 - (a) Ammunition ki safai aur damage check.
 - (b) Barrel surakshit disha.
 - (c) Bhar hukam se.

- (d) Sahi khali kar.
- (e) Barkhilap karwai par fire band.
- (f) Roken dur karte samay savdhani.

BHAG III : DEMONSTRATION

13. Ustad range drill ki tartib ka ek sahi aur durust namuna byan ke saath den.

SANKSHEP

14. Drust range drill ka follow kara bahut hi zaruri hai kiyon ki, is se samay ki bachat hoti hai aur koi anhani ya hadsa bhi nahi hota. Firing ke dauran range drill ki laparwahi, yah range drill ka andekhi se dukhad ghatnae ho sakne ki sambhawna hai, aur is men ksi ki jaan bhi ja sakti hai.

LESSON PLAN : WT 8
THEORY OF GROUP AND SNAP SHOOTING

Period	-	One
Type	-	Lecture/Demo/Practice
Code	-	WT 8
Term	-	II / III (SD/SW)

Training Aids

1. Target 1'x1', Charts, Sand Bag and Ground Sheet.

Time Plan

2. (a) Introduction & Uddesh - 03 Min
- (b) Theory of Groups - 15 Min
- (c) Snap Shooting - 15 Min
- (d) Sankshep - 02 Min

INTRODUCTION

3. Ahook nishane baaji ke buniyadi usool hain majbot pakar, durust sisht lena, aur durust trigger operation ki karwahi. Is liye har ek firer ko sisht lene ke saath –saath sahi trigger operation ki karwahi achhi tarah se aani chahiye.

UDDESH

4. Theory of Groups aur Snap Shooting ke bare men jankari dena hai.

TARTIB

5. Ye sabak do bhagon mein chalaya jayega:-
 - (a) Bhag I - Theory of Groups.
 - (b) Bhag II - Miniature Range Snap Shooting.

BHAG I : THEORY OF GROUPS

Group Aur Uski MPI

6. Firing ke dauran yeh janna zaruri hai ki jab hum kabhi bhi ek se jada goli fire karten hai, jin ki sisht, ammunition, weapon ya firing conditions sman hain, to sabhi goli target pe ek hi jagah nahi lagen gi. Is men ek pattern banta hai, aur is ke kai karan ho sakte hain. Ek group banane ke liye, panch goli jo ki ek sath aur ek hi aming point par fire ki hon, ko liya jata hai. In panch goliyon ke group ke Kendra Bindu (central point) ko group ka Mean Point of Impact (MPI) kahte hain.

Grouping Capacity

7. Kisi bhi firer duwara fire ki gayi panch golion ke circle ke diare (diameter) ko us firer ki Grouping Capacity kahate hain. Coaching ya scoring ke hisab se firers ko unki Grouping Capacity ke mutabik classify kiya jata hai, jaise 2 inch, 4 inch etc. Yeh grouping, 100 m ya 25 m pe nahi jati hai.
8. Yeh jan lena chahiye ki, ek firer ki Grouping Capacity ka anuman tabhi sahi lage ga jab, usne har goli sahi sisht le ke fire ki ho. Agar kisi firer se, galti se, bagair durust sisht ke, koi goli fire ho jati hai to, us goli ko Grouping Capacity ke liye nazarandaz kar dena chahiye.
9. Grouping ki ahmiyat, hatiyar ki zeroing ke liye bahut hi zaruri hai. Agar koi firer, ek hi point of aim (POA) ko lekar, panch goli fire karta hai, aur uska MPI, point of aim se hat kar hai, to is ka matlab us weapon ko zero karna zaruri hai. Zeroing ke liye, foresight ya back sight, men kuch tabdili ki jati hai taki, MPI aur POA ke bich ka fasla bilkul kam ho.
10. Ek bar kisi firer ki grouping hojati hai to, uske baad, us firer ki zemewari hai ki who, samay samay par apni grouping ko barkar rakhe aur, ho sake to us men aur bhi improvement laye.

BHAG II : MINIATURE RANGE SNAP SHOOTING

11. Grouping aur Zeroing ke baad Snap Shooting fire karna chahiye. Snap shooting men target bahut hi thode samay ke liye nazar ata hai. Is ke liye yeh janna zaruri hai ki fire karne ke liye samay kafi hai agar, firer ko apne upar pura bharosa hai.
12. Snap shooting ke liye sikhlai is prakar se hoti hai :-
 - (a) **Stage-1 Automatic Alignment.** Is men squad, semi circle men lying position men hota hai aur, instructor centre men hota hai aur, aiming mark instructor ki ankh hoti hai. Aiming alignment ko aiming disc ki madad se check karne ke liye, individually, instructor “up” ka word of command deta hai to us pe firer instructor ki ankh pe nishana lagaten hain.
 - (b) **Stage-2 Automatic Alignment with Correct Hold and Trigger Operation.** Is stage men “up” ke command pe firer, rifle ko upar lata hai, sahi sisht leta hai, mazboot pakarta hai aur fire karta hai. Fir weapon ko dobara load karta hai aur dobara practice karta hai. Is men accuracy pr jada jor hai na ki speed pe.
 - (c) **Stage 3,4 & 5.** Is stage men snap shooting practice firing, targets pe alag alag ranges pe ki jati hai. Is ke liye per goli 7 sec ka samayhota hai.
13. Short range pe representative miniature targets ka istemal hota hai aur, samay ko me 7 se 4 seconds kar diya jata hai. Ek din men do se jada practice nahi karni chahiye.
14. **Continuous Snap Shooting.** Is men jaise jaise target dikhta hai, wise hi us pe fire kiya jata hai. Buniyadi usul yeh hai ki “ Ek Goli Ek Dushmsn/Target” aur “ Shoot to Kill”.
15. **Dhiyan Men Rakhne Wali Baten.**
 - (a) ‘Accuracy’ speed se jada zaruri hai.
 - (b) POA ko bataya nahi jata.
 - (c) Butt hamesha kandhe pe hota hai, re-aiming ka samay bachane ke liye.
 - (d) Durust bolt ki karwahi taki reloading me samay barbad na ho.

SANKSHEP

16. Ek ache firer ke liye durust grouping aur zeroing karna bahut hi zaruri hai. Is se target pe durust firing ki ja sakti hai. Snap shooting ke liye durust zeroing ke alawa, durust sisht aur trigger operation ki zarurat hai. Hamesha ‘ek goli ek dushman’ ka buniyadi usul yaad rakhe.

LESSON PLAN : WT 9
SHORT RANGE FIRING AND AIMING II

Period	-	One
Type	-	Lecture/Demo/Practice
Code	-	WT 9
Term	-	I / II / III (SD/SW)

Training Aids

1. Red flag 6'x6', Flag pole 20', Target Plate 3'x 2', Red Jacket, Helmets, Repairing Material, Butt Register, Sand Bag and Ground Sheet.

Time Plan

2.	(a)	Introduction & Uddesh	-	03 Min
	(b)	Short Range Firing	-	18 Min
	(c)	Aiming II - Alternation of Sight	-	19 Min

INTRODUCTION

3. Jis tarah bimar ke lakshan ko dekhkar bimari ka pata chalta hein, usi tarah, target par goliyon ki maar ya group ka vishleshan karne se, honewali galtiya ka pata chalta hain. Group me goliyon ki maar aur unke failav ko dekhkar firer ki kabliyat ka asani se pata lagaya ja sakta hai.

UDDESH

4. Short range pe Firing aur Sisht men badly ke bare men jankari den hai.

TARTIB

5. Is lec ko do bhagon mein chalaya jaega :-

- | | | | |
|-----|---------|---|-----------------------|
| (a) | Bhag I | - | Short Range Firing. |
| (b) | Bhag II | - | Alternation of Sight. |

BHAG I : SHORT RANGE FIRING (.22 RIFLE)

<u>Practice</u>	<u>Target Type</u>	<u>Range In Yards</u>	<u>Round</u>	<u>Instructions</u>	<u>Scoring</u>
Deliberate	1' x 1'	25	10	(a) Position lying supported. (b) One practice of 5 rounds	Bull & Inner - 3 points Magpie - 2 points Outer - 1 points HPS - 15 Points

Note :- Out of 12 rounds authorized per cadets, 2 rounds will be pooled for zeroing and re-classification of failures.

BHAG II : AIMING II - ALTERATION OF SIGHT

6. **Zarurat.** Firing ke dauran agar yeh pata chalta hai ki, durust aim aur firing ke babzood goli POA se upar ya niche lagti hai to, back sight ko adjust karke setting karna zaruri hai.

7. **Elevation.** Back sight ko jo adjustment karni hai who niche diye table ki madad se ki ja sakti hai jis men, 100 yds pe jo change karte hain, us se MPI kitni badalti hai.

<u>Range Target</u>	<u>Rise or Drop of MPI on Target</u>
200 Yards	6 inches
300 Yards	12 inches
400 Yards	18 inches
500 Yards	24 inches

8. Sight men 50 yards ki alteration se, upar diye hue effect adhe ho jate hain, aur agar sight men 200 yards ki alteration ki jati hai to, upar diya hua effect double ho jata hai.

SANKSHEP

9. Range pe durust firing karna sabhi ka kartavya hai. Is liye agar goli target pe nahi lagti hai to turant sight men alteration kar ke goli target pe marna zaruri hai.

INDEX**DISASTER MANAGEMENT & CIVIL AFFAIRS**

<u>Ser No</u>	<u>Lesson Code</u>	<u>Subject</u>	<u>Cat</u>	<u>Page No</u>
1.	DM 1	Civil Defence Organisation and NDMA	SD / SW	123
2.	DM 2	Types of Emergencies / Natural Disasters	SD / SW	129
3.	DM 3	Fire Services & Fire Fighting	SD / SW	133
4.	DM 4	Traffic Control During Disaster Under Police Supervision	SD / SW	139
5.	DM 5	Essential Services and their Maintenance	SD / SW	142
6.	DM 6	Assistance During Natural / Other Calamities : Flood/Cyclone/Earth Quake/Accident Etc	SD / SW	145
7.	DM 7	Setting up of Relief Camp During Disaster Management	SD / SW	149
8.	DM 8	Collection & Distribution of Aid Material	SD / SW	153

LESSON PLAN : DM 1
CIVIL DEFENCE ORGANISATION AND NDMA

Period	-	One
Type	-	Lecture
Code	-	DM 1
Term	-	I (SD/SW)

Training Aids

1. Computer Slides, Charts, Pointer, Black Board & Chalk.

Time Plan

2.	(a)	Introduction	-	05 Min
	(b)	Civil Defence Organisations	-	15 Min
	(c)	National Disaster Management Authority	-	15 Min
	(d)	Conclusion	-	05 Min

INTRODUCTION

3. Civil Defence was first established in India on 24th October 1941. Two significant events took place after independence which gave a major fillip to Civil Defence in India. The first was the Chinese aggression in November, 1962 and the other was the Indo-Pakistan conflict in September 1965, when, for the first time after Independence, the nation was subjected to enemy air attacks. This led to considerable rethinking about the policy and scope of Civil Defence and as a result the Civil Defence policy, as it exists today, was evolved.

4. Disasters disrupt progress and destroy the hard-earned fruits of painstaking developmental efforts, often pushing nations, in quest for progress, back by several decades. Thus, efficient management of disasters has, in recent times, received increased attention both, within India and abroad.

AIM

5. To acquaint the NCC Cadets about the Civil Defence Organisations and National Disaster Management Authority (NDMA).

PREVIEW

6. The lecture will be conducted in following parts:-
 - (a) Part I - Civil Defence Organisation and their Duties.
 - (b) Part II - National Disaster Management Authority.

PART I : CIVIL DEFENCE ORGANISATIONS

General

7. The Civil Defence Act of India was enacted by Parliament on May 1968. Today, Civil Defence' includes any measures, not amounting to actual combat, for affording protection to any person, property, place or thing in India or any part of the territory thereof, against any hostile attack, whether from air, land, sea or other places, or for depriving any such attack of the whole or part of its effect.

8. Civil Defence is a much misunderstood subject because, it is often confused with the air raid precautions taken during the war. There are many other measures necessary to deal with effects of direct and indirect raids and such measures cannot be disassociated from the Civil Defence measures. Civil Defence measures mainly consist of the following:-

- (a) **Protective Preventive Measures.** Measures which may be taken before an air raid, such as dispersal of population and industries, camouflage, preparation of shelter, warning and training etc.
- (b) **Control Measures.** Measures taken immediately after the raid, such as reconnaissance, reporting of damage and unexploded bombs, rescue of casualties, control of services, clearance of debris and extinguishing of fires.
- (c) **Restorative Measures.** The measures which become necessary after an air raid include feeding, providing shelter and clothing, salvage of property, disposal of dead, disposal of unexploded bombs, control of infection and contamination, repair of damages caused to utility services etc.

Civil Defence Organisations

9. Civil Defence is primarily organised on voluntary basis except for a small nucleus of paid staff and establishment which is augmented during emergencies. The present target of Civil Defence volunteers is 12.49 lakhs, out of which 6.0 lakhs have already been raised and 4.8 lakhs have been trained. These volunteers are administered and trained by 68 Deputy Controllers, 17 Medical Officers and 503 Civil Defence Instructors, which are full time paid posts.

10. **National Level.** At the national level, the Home Ministry is responsible for the Civil Defence. It has under its direct control, the Directorate of Civil Defence, headed by a Director General - usually a senior police officer, who is responsible to advise the Home Ministry on all matters relating to Civil Defence. The Civil Defence organization basically comprises of the Home Guards, NCC and the Fire-Fighting Units. Most of the central ministries have a civil defence cell which gets activated during emergency and is responsible for rendering specialist advise pertaining to their respective ministries to the Home Ministry. In addition, The Ministries of Defence and Railways are responsible for civil defence on properties owned or managed by them.

11. The Civil Defence Corps has the following 12 services in which volunteers are trained:-

- (a) **Headquarters Service.** This service works under control of Civil Defence.
- (b) **Warden's Service.** It is a link between the public and the authorities. This service is responsible for organizing self-help parties, fire parties and to check light restrictions, report damages and guide homeless to the Rest Centres.
- (c) **Fire Fighting Service.** They detect small fires and put out the same.
- (d) **Casualty Services.** The functions of this service are:-
 - (i) Rendering first aid on the spot.

- (ii) Providing transport to casualties for short distances.
- (iii) To send various casualties for further treatment.
- (e) **Communication Services.** This service is responsible for:-
 - (i) Receipt and dissemination of air raid warning.
 - (ii) Provision of co-ordination and control facilities.
 - (iii) Provision of communication between warden posts, control centres through messengers or telephone etc.
- (f) **Rescue Services.** Their duty is to rescue the injured and personnel trapped under the debris.
- (g) **Welfare Services.** It is responsible to supply information about missing and dead etc. to provide shelter, food and clothing and to arrange evacuation from vulnerable areas.
- (h) **Depot and Transport Services.** It is this service which is responsible to send various services to the scene of the incident and provide the necessary transport required from time to time.
- (j) **Salvage Service.** It is responsible to salvage the damaged property and keep it in safe custody.
- (k) **Corpse Disposal Service.** This service is responsible for collection, identification and disposal of dead bodies.
- (l) **Supply Service.** This service is responsible for planning, organizing and procuring necessary equipment for Civil Defence Services and its proper storage and quick distribution of equipment at the time of need.
- (m) Besides the above noted services, the Civil Defence organisation will be required to set up Repair and Demolition Parties and make arrangements for the care of animals through appropriate existing agencies operating in the town.

12. **State Level Organisation.** Each State and Union Territory government has, under the overall control of its Inspector General of Police, a Director General of Home Guards and Civil Defence. As in the case of the central government, he is a senior police officer and is responsible for controlling fire departments as well.

13. **District Level Organisation.** In a district, the District Magistrate is the ultimate authority on Civil Defence. He is designated as the Controller of Civil Defence. He is responsible for implementation of all Civil Defence measures by the district departmental heads such as Civil Surgeon, Superintendent of Police, PWD Engineer, Publicity Officers etc. They are appointed by him as in-charge of various Civil Defence Services. He also constitutes an Advisory Committee out of the people possessing qualities of leadership and discipline who can arouse and sustain public interest in the Civil Defence Services.

PART II : NATIONAL DISASTER MANAGEMENT AUTHORITY (NDMA)

General

14. India is vulnerable, in varying degrees, to a large number of natural as well as man-made disasters. 58.6 per cent of the Indian landmass is prone to earthquakes of moderate to very high intensity. Over 40 million hectares of land (12 per cent of total land) is prone to floods and river erosion. Of the 7,516 km long coastline, close to 5,700 km is prone to cyclones and tsunamis. 68

percent of the cultivable area is vulnerable to drought. Hilly areas are at risk from landslides and avalanches. India also has had a history of natural disasters in recent years. Thus the importance of Disaster Management in India.

15. On 23 December 2005, the Government of India took a defining step by enacting the Disaster Management Act of India, which envisaged the creation of the National Disaster Management Authority (NDMA), headed by the Prime Minister.

Organisation of NDMA

16. **National Level.** At the national level, the NDMA, will be the apex body for disaster management, and will be headed by the Prime Minister. The NDMA is mandated to deal with all types of disasters; natural or man-made. It will be responsible for laying down policies, plans and guidelines for Disaster Management and coordinating their enforcement and implementation for ensuring timely and effective response to disasters. In addition, it will also be responsible to:-

(a) Approve the National Disaster Management Plans and Disaster Management Plans of the Central Ministries/Departments.

(b) Take such measures, as it may consider necessary, for the prevention of disasters, or mitigation, or preparedness and capacity building, for dealing with a threatening disaster situation or disaster. Central Ministries / Departments and State Governments will extend necessary cooperation and assistance to NDMA for carrying out its mandate.

(d) Oversee the provision and application of funds for mitigation and preparedness measures. NDMA has the power to authorise the Departments or authorities concerned, to make emergency procurement of provisions or materials for rescue and relief in a threatening disaster situation or disaster.

(e) Exercise superintendence, direction and control of the National Disaster Response Force (NDRF).

(f) Lay down framework of broad policies and guidelines for working of the National Institute of Disaster Management (NIDM).

17. **National Executive Committee (NEC).**

(a) The NEC is the executive committee of the NDMA, and is mandated to assist the NDMA in the discharge of its functions and also ensure compliance of the directions issued by the Central Government. The NEC is to coordinate the response in the event of any threatening disaster situation or disaster.

(b) The NEC comprises the Union Home Secretary as Chairperson. The Secretaries various important Ministries/Departments of the govt and the Chief of the Integrated Defence Staff of the Chiefs of Staff Committee are members. Secretaries in the Ministry of External Affairs, Earth Sciences, Human Resource Development, Mines, Shipping, Road Transport & Highways, and the Secretary, NDMA will be special invitees to the meetings of the NEC.

(c) The NEC is responsible to prepare the National Plan for Disaster Management based on the National Policy on Disaster Management. The NEC will monitor the implementation of guidelines issued by NDMA. It will also perform such other functions as may be prescribed by the Central Government in consultation with the NDMA.

18. **State Disaster Management Authority (SDMA).**

(a) At the State level, the SDMA, will be headed by the Chief Minister, who will lay down policies and plans for Disaster Management in the State. It will, inter alia approve the

State Plan in accordance with the guidelines laid down by the NDMA, coordinate the implementation of the State Plan, recommend provision of funds for mitigation and preparedness measures and review the developmental plans of the different Departments of the State to ensure the integration of prevention, preparedness and mitigation measures.

(b) The State Government shall constitute a State Executive Committee (SEC) to assist the SDMA in the performance of its functions. The SEC will be headed by the Chief Secretary to the State Government and will coordinate and monitor the implementation of the National Policy, the National Plan and the State Plan. The SEC will also provide information to the NDMA relating to different aspects of Disaster Management.

19. **District Disaster Management Authority (DDMA).**

(a) The DDMA will be headed by the District Collector, Deputy Commissioner or District Magistrate as the case may be, with the elected representative of the local authority as the Co Chairperson.

(b) The DDMA will act as the planning, coordinating and implementing body for DM at the District level and take all necessary measures for the purposes of DM in accordance with the guidelines laid down by the NDMA and SDMA. It will, inter alia prepare the District DM plan for the District and monitor the implementation of the National Policy, the State Policy, the National Plan, the State Plan and the District Plan.

(c) The DDMA will also ensure that the guidelines for prevention, mitigation, preparedness and response measures laid down by the NDMA and the SDMA are followed by all the Departments of the State Government at the District level and the local authorities in the District.

20. **Local Authorities.** For the purpose of this Policy, local authorities would include Panchayati Raj Institutions (PRI), Municipalities, District and Cantonment Boards, and Town Planning Authorities which control and manage civic services. These bodies will ensure capacity building of their officers and employees for managing disasters, carry out relief, rehabilitation and reconstruction activities in the affected areas and will prepare DM Plans in consonance with the guidelines of the NDMA, SDMAs and DDMA.

21. **National Disaster Response Force (NDRF).**

(a) For the purpose of specialised response to a threatening disaster situation or disasters/ emergencies both natural and man-made such as those of CBRN origin, the Act has mandated the constitution of a National Disaster Response Force (NDRF). The general superintendence, direction and control of this force shall be vested in and exercised by the NDMA and the command and supervision of the Force shall vest in an officer to be appointed by the Central Government as the Director General of Civil Defence and National Disaster Response Force.

(b) Presently, the NDRF comprises eight battalions and further expansion may be considered in due course. These battalions will be positioned at different locations as may be required. NDRF units will maintain close liaison with the designated State Governments and will be available to them in the event of any serious threatening disaster situation. While the handling of natural disasters rests with all the NDRF battalions, four battalions will also be equipped and trained to respond to situations arising out of CBRN emergencies.

(c) The NDRF units will also impart basic training to all the stakeholders identified by the State Governments in their respective locations.

CONCLUSION

22. Civil Defence and Disaster management is an important activity both during peace (natural disasters) or during war. NCC with its vast trained resource can play an important role and help in both, the Civil Defence and the Disaster management.

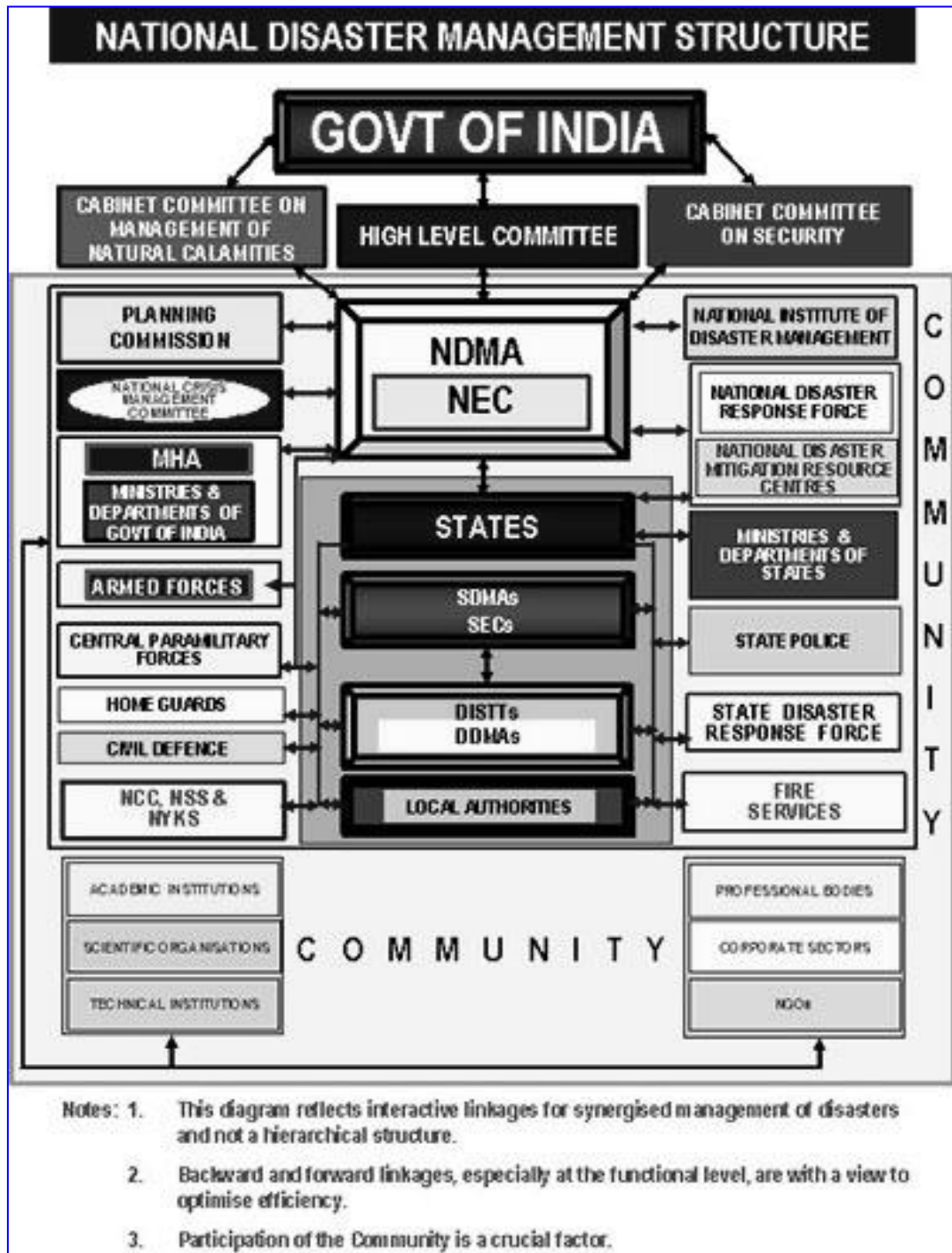

LESSON PLAN : DM 2
TYPES OF NATURAL DISASTERS

Period	-	One
Type	-	Lecture
Code	-	DM 2
Term	-	I (SD/SW)

Training Aids

3. Computer Slides, Charts, Pointer, Black Board & Chalk

Time Plan

4.	(a)	Introduction	-	05 Min
	(b)	Classification of Disasters	-	15 Min
	(c)	Types of Natural Disasters	-	15 Min
	(d)	Conclusion	-	05 Min

INTRODUCTION

3. Since the dawn of civilization, human society, natural environment and disasters have been closely interlinked. Natural disasters and the increasing environment degradation world-wide are serious threats to development. Natural disasters threaten all three dimensions of development to include economic, social and environmental. In the past twenty years, earthquakes, volcanic eruptions, landslide, floods, tropical storms, droughts and other natural calamities have killed over three million people, inflicted injury, disease, homelessness and misery on one billion others, and caused billions of dollars of material damage. 90 percent of the natural disasters and 95 percent of the total disaster-related deaths world-wide, occur in the developing countries.

4. The term disaster is commonly used to denote any odd event 'natural or man made' which brings about immense misery to a region and it becomes difficult to cope with the situation through local resources.

AIM

5. To acquaint the NCC Cadets about the types of Natural Disasters.

PREVIEW

6. The lecture will be conducted in following parts:-

- | | | | |
|-----|---------|---|------------------------------|
| (a) | Part I | - | Classification of Disasters. |
| (b) | Part II | - | Types of Natural Disasters. |

PART I : CLASSIFICATION OF DISASTERS

7. Disasters can be classified based on nature of onset (rapid/ slow), natural and manmade disasters as under:-

- (a) **Natural Disasters**. These are of the following types :-
- (i) **Wind Related**. Storms, Cyclones, Tornados, and Tidal Waves.
 - (ii) **Water Related**. Floods/Flash Floods, Cloudburst, Excessive Rains and Drought.
 - (iii) **Earth Related**. Earthquakes, Tsunamis, Avalanches, Landslides and Volcanic Eruptions.
- (b) **Man Made Disasters**. These can be classified as under :-
- (i) **Accidents**. Road, rail, air, sea accidents or building collapse.
 - (ii) **Industrial Mishaps**. Gas leaks, explosion, sabotage and safety breaches.
 - (iii) **Fires**. In buildings, coal fields or oil / gas fields and oil / gas storage depots.
 - (iv) **Forest Fires**. In tropical countries, forest fires are often manmade.
 - (v) **Contamination/Poisoning**. Incidents of mass food poisoning, water contamination, illicit-liquor poisoning and epidemics.
 - (vi) **Terrorists Activities**. Serial Blasts / explosions in public transport or markets.
 - (vii) **Ecological**. Pollution of air, water, noise, soil degradation, loss of biodiversity, global warming, sea level rise, toxic wastes and nuclear accidents.
 - (viii) **Warfare**. Conventional, chemical, biological or nuclear.

PART II : TYPES OF NATURAL DISASTERS

8. **Volcanoes**. The word “volcano” comes from the Latin word Vulcan, the Roman god of fire. Volcanoes erupt when the lower levels of the earth’s crust push up on hot magma causing the volcano to burst through the top layer of the earth. When a volcano erupts, magma, ashes, and other gases are released and pushed upward from beneath the earth’s surface. The melted molten rock is called lava when above the surface, and is referred to as magma when below the surface. When a volcano erupts, the molten rock that is spewed from the volcano builds up and begins to form a mountain-like structure. Because the molten lava is so hot, sometimes reaching over 2,000 degrees Fahrenheit, anything that it comes in contact with it can burn or melt. The volcano can spew lava, dust, ashes, and deadly gases. After the molten lava cools down, it hardens and turns into hard molten rock. The ash that is sent from the top of the volcano can be carried hundreds of miles by the wind. Volcanoes can be both, active or dormant volcanoes and can be found both, on land or under the sea.

9. **Landslides**. Landslides are mostly caused by movement in the ground and the force of gravity pulling down on all earthly objects. Landslides can also be caused by heavy rain, earthquakes, and even some man-made causes such as road work. Landslides usually consist of falling rocks and sliding earth in addition to failure in the Earth’s surface. Landslides often occur in conjunction with other natural disasters such as volcanic eruptions, earthquakes, and other faults in the earth. Effects of landslides include collapsing buildings, collapsing roads and even sometimes causing death.

10. **Earthquakes**. Earthquakes are one of the many powerful natural disasters caused when there is a shift, collision, or sudden release of energy in the Earth’s crust. Sometimes called tremors and temblors, earthquakes usually occur on the boundaries of, or near, the lines where the Earth’s tectonic plates collide and slide past each other. This is called a fault line. Changes in

the Earth's surface usually result in earthquakes. Earthquakes consist of shaking and displacement of the ground. Depending on the intensity of the earthquakes, they can cause buildings to collapse, which sometimes results in fatalities. The Richter Magnitude Scale is used to classify and measure the magnitude of earthquakes. The Richter Scale was invented by Charles F. Richter in 1935, and it has a scale from 1-9.

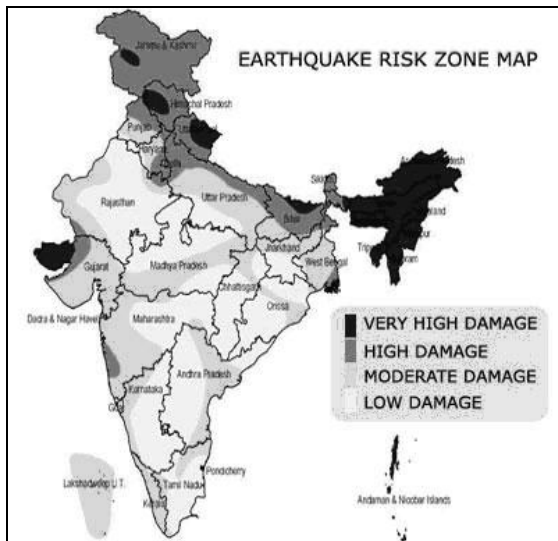

Earthquake Zone : India

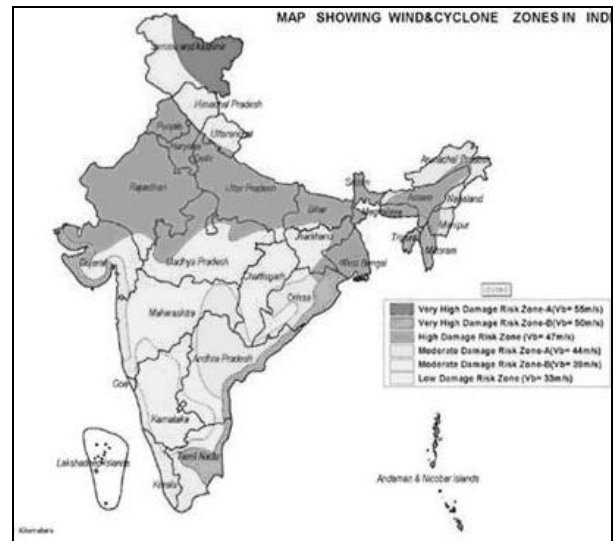

Wind & Cyclone Zone : India

11. **Tsunamis.** “Tsunami” is a Japanese word meaning “harbor wave.” Tsunamis usually take place in the ocean, but can also occur in large lakes. Caused by an underwater earthquake, volcano, landslide, or other type of explosion, tsunamis are giant waves that can destroy entire cities. Tsunamis can range anywhere from a few inches to several yards high. Some large tsunamis have been as tall as 100 feet while some have been less than 20 feet tall and still caused extensive damage. These great walls of water can gain speed as they approach the shore, sometimes up to 500 miles per hour. Tsunamis have tremendous destructive power and can destroy hundreds of lives and homes each year.

12. **Hurricanes.** Sometimes called Tropical Cyclones, Typhoons, or Willy-Willies. Hurricanes can rip up trees, destroy crops, and flatten buildings. Torrential rain causes flooding and coastal regions may be swamped by huge waves whipped up by winds that blow as fast as 300 km/h (185 mp). Hurricanes start to form when the Sun's heat stirs up moist air over the oceans, where the temperature at the centre of the storm, called the eye, can be more than 300 km (185 miles) across and the winds only gale force. But as the eye narrows to about 50 km (30 miles) across, the winds begin to swirl around it at hurricane force. Cyclones pose a major threat to lives and property in many parts of the world.

13. **Floods.** It can arise from abnormally heavy precipitation, dam failures, rapid snow melting, river blockages or even burst water mains. It is usually sudden in onset. Types of floods can further be classified into Inland and Coastal floods. Major floods result in physical damage, deaths and injuries, problems in drinking water supply and food shortages and displacement of population.

14. **Droughts.** If, over about two weeks, there is less than 0.2 mm (1/100in) of precipitation, there is said to be a drought. Without reservoirs, there is not enough water for people and crops. Some places have extreme drought which lasts for many Terms. Droughts have disastrous and long term impact on the economy and can affect a large segment of the society which may last for months and in some cases several Terms. Generally, drought situation may be defined as a temporary reduction in water or moisture availability significantly below the normal or expected amount for a specific period. Drought is a slow onset phenomenon.

CONCLUSION

15. Natural disasters and the increasing environment degradation world-wide are serious threats to development. Natural disasters threaten all three dimensions of development to include economic, social and environmental. Natural calamities have killed over three million people, inflicted injury, disease, homelessness and misery on one billion others. It is therefore important for all of us to be fully aware of the various types of Natural Disasters and take measures to minimize losses of all types.

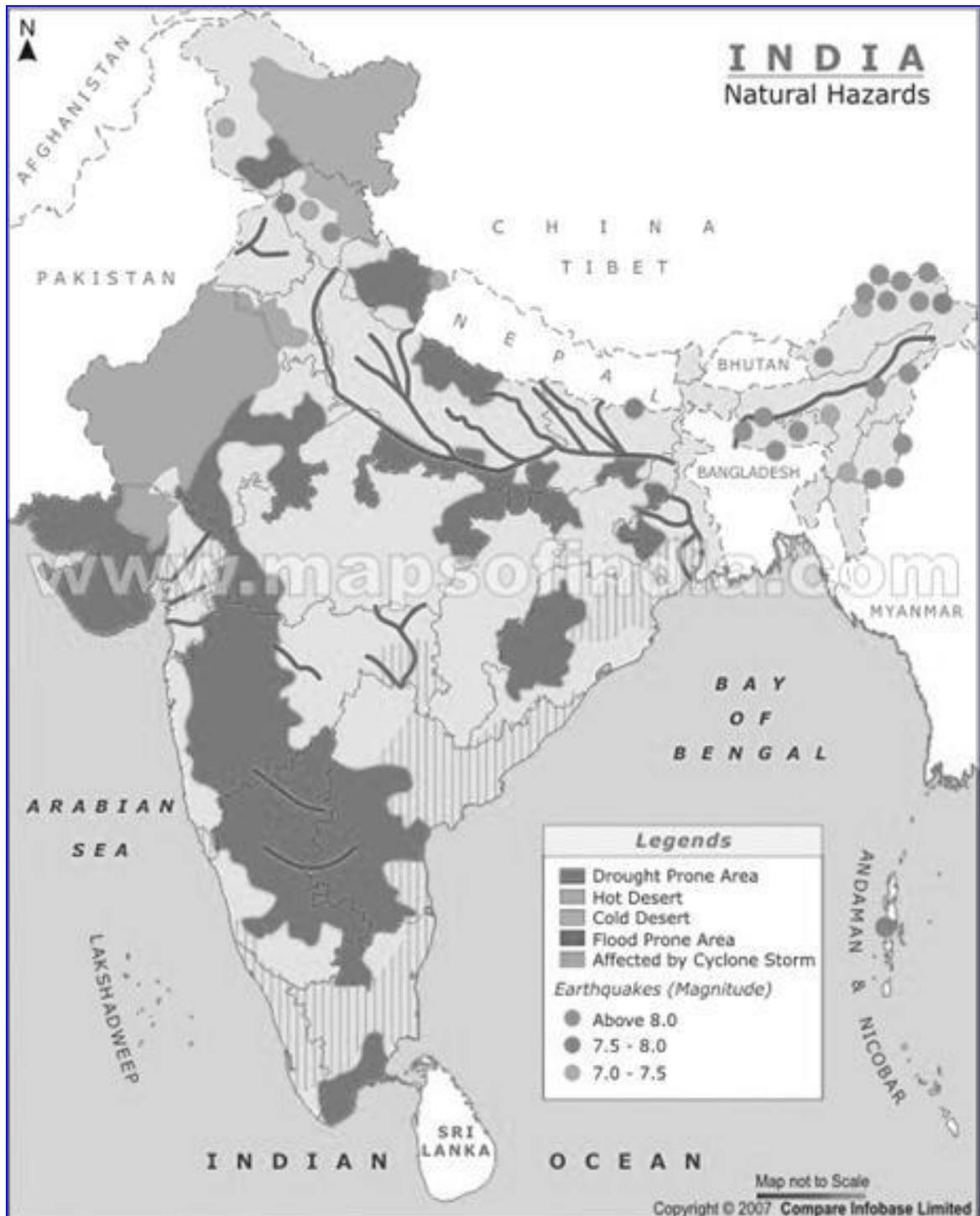

LESSON PLAN : DM 3
FIRE FIGHTING

Period	-	One
Type	-	Lecture
Code	-	DM 3
Term	-	II (SD/SW)

Training Aids

1. Computer Slides, Charts, Pointer, Black Board & Chalk.

Time Plan

2.

(a)	Introduction	-	05 Min
(b)	Causes and Prevention of Fire	-	10 Min
(c)	Fire Fighting	-	20 Min
(d)	Conclusion	-	05 Min

INTRODUCTION

3. Fire is a major cause for destruction of property / lives these days. Due to increase in the standard of living, electrical goods, air conditioners and cooking gas are found in most of the houses. Also, due to the influx of multinational companies, most offices, shopping malls and hospitals have air conditioners. With the influx of these electrical gadgets and cooking gas, occurrences of fire incidents have increased manifold, especially during winters and summers. It is therefore essential that everyone should be aware of how to prevent fire hazards or to provide assistance in firefighting.

AIM

4. To acquaint the NCC Cadets about the Fire Services and Fire Fighting.

PREVIEW

5. The lecture will be conducted in following parts :-

(a)	Part I	-	Causes and Prevention of Fire.
(b)	Part II	-	Fire Fighting.

PART I : CAUSES AND PREVENTION OF FIRE

What is Fire

6. Fire is the outcome of either heating or over heating of a combustible substance to the required temperature or igniting an inflammable material. The following three elements are essential for creation of fire and its continuation:-

- (a) Oxygen.

- (b) Sufficient heat to raise the temperature of fuel to its burning point or ignition.
- (c) Combustible or burnable material (Solid, Liquid or Gas).

7. It should, therefore, be remembered that three things or conditions are necessary to start a fire and to sustain it. Fuel (Combustible Material), Oxygen (Air) and Sufficient Heat to raise the temperature of the fuel to its burning point, must be present at the same place and time.

Modes of Spread

8. The fire spreads by the transmission of heat in one or any combination of the following four ways:-

- (a) **Conduction**. Transfer of heat by the intermediary material. Many materials which will not burn easily particularly metals are good conductors for transmitting heat. These materials when overheated or heated by the fire, may ignite other combustible material with which these may be in contact eg short circuiting of electrical wires due to overloading.
- (b) **Convection**. Transfer of heat through gases or smoke. Gases tend to rise until ceiling or roof is reached after which they spread sideways in a mushroom manner and ignite combustible materials located at higher levels than the original fire e.g. fire spreading onto top floor. The best method to check this is to remove or cool the combustible materials.
- (c) **Radiation**. Radiation means transfer of heat from the source of fire, without heating the midway media e.g. air. The effect of radiation can be countered by forming a 'water curtain' between the fire and the object to be protected or the object may be removed or cooled.
- (d) **Direct Burning**. This phenomenon is self-explanatory. Direct burning is often due to a combination of the above two or three factors viz, conduction, convection and radiation.

Prevention of Fire

9. The following measures must be taken to prevent occurrence of fire incidents:-

- (a) **Domestic Fires.**
 - (i) **Kitchen Fires.** These fires can be prevented by following measures:-
 - (aa) Don't keep any inflammable material like petrol, kerosene or clothing near the fire or the gas.
 - (ab) Always check the gas cylinder, gas pipe for leakage. Keep the kitchen well ventilated to prevent leaking gas accumulation. Switch off the regulator when the gas is not in use.
 - (ac) Before lighting the gas, ensure there is no gas leakage.
 - (ad) Keep children away from gas or fire or stoves.
 - (ae) Before leaving the kitchen, ensure that the gas and kero stoves are switched off and there are no burning embers in the 'Chula'.
 - (ii) **Other Fires.**
 - (aa) Ensure that no electrical circuit is 'overloaded'.

- (ab) Ensure that good quality electrical items are used.
 - (ac) Ensure that all electrical gadgets are switched off when not in use, eg TV, AC, room heater or iron.
 - (ad) Ensure that smokers do not leave any burning cigarettes or stubs in ashtrays near inflammable material.
 - (ae) Don't ignite any fire cracker inside the house.
- (b) **Fire in Public Places.**
- (i) Ensure that smokers do not leave any burning cigarettes or stubs in public dustbins or near inflammable material in closed AC offices, shopping malls or cinema halls.
 - (ii) Don't ignite any fire cracker near petrol pumps, in crowded markets, near inflammable material or inside malls.

PART II : FIRE FIGHTING

Fire Fighting

10. Fire can be extinguished if any one or more of the three main constituents are removed from the scene of fire. The fire can thus be extinguished by:-

- (a) **Starvation.** Starvation means removal of fuel combustible material and it can be achieved by either segregation of fire and un-burnt fuel by removing either of them e.g. removing un-burnt combustible materials from a room on fire with the help of hook or otherwise or division of a large fire into several smaller ones to prevent the radiated heat from setting alight combustible material at some distance.
- (b) **Cooling.** Cooling implies the removal of heat to lower the temperature of burning material to a point below its ignition point. This is usually achieved by water. When water is poured over a burning material, it absorbs heat, becomes hot and flows away or is converted into steam. The burning substance loses heat to the water and its temperature comes down to below its ignition temperature and so the fire is extinguished.
- (c) **Smothering.** Smothering means 'Choking' or restricting the supply of Oxygen (Air) to the burning material. This is also called 'blanketing' and is achieved by sealing all the burning material from Oxygen (Air) by covering it with sand/dry earth/ foam or by creating an atmosphere over the fire of heavier than air inert gas.

Fire Fighting Parties

11. To carryout the above methods, the fire services and fire parties are organized at the level of every city, town and important establishments.

12. **House Fire Parties.** It consists of four persons who carry stirrup pumps and water buckets. They act as fire watchers and work under the orders of the wardens. They carry one stirrup pump, two buckets, one torch and one hand axe. One steel helmet and one whistle per member is envisaged as personal equipment.

13. **Auxiliary Fire Services.** This consists of eight persons with Trailer Pump which can throw water at the fire from a distance. The members of this Service are drawn from the Home Guards.

Fire Fighting Equipment

14. Fire Fighting Equipment can be divided into the following four categories:-

- (a) Fire Extinguishers.
- (b) Stirrup Pumps.
- (c) Buckets.
- (d) Fire Beaters and Hooks.

15. **Fire Extinguishers.** For the convenience of study, these could be grouped as under:-

- (a) **Soda Acid Extinguishers.** These fire extinguishers are used for extinguishing fires involving ordinary combustible material, where the cooling effect is achieved by water or solution containing large percentage of water. Such extinguishers are conical /cylindrical in shape.
- (b) **Foam Type or Dry Chemical Powder Extinguishers.** These fire extinguishers contain dry chemicals or solution and are exclusively meant for extinguishing fires involving inflammable liquids such as oils, fats, or grease, where blanketing the fire to isolate it from Oxygen (Air) is required.
- (c) **CTC Carbon dioxide and Dry Chemical Extinguishers.** These fire extinguishers contain chemicals, either liquid, gas or dry, and are mainly used to fight fires involving 'Live' electrical equipment etc. where, the use of an electrically non-conductive extinguishing agent is of most importance.

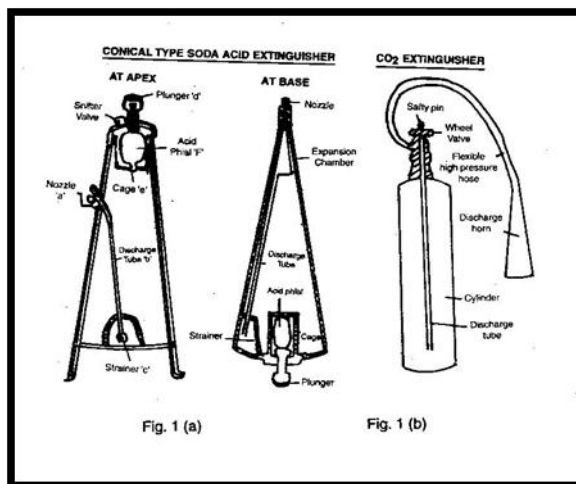

Soda Acid Fire Extinguisher

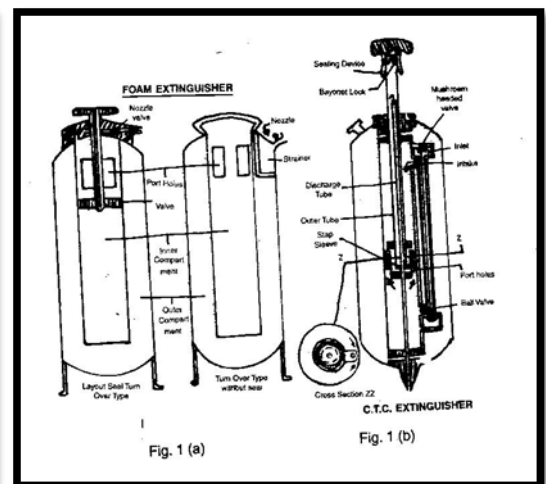

Foam Fire Extinguisher

(d) The main advantages of these extinguishers are:-

- (i) They are easy to operate.
- (ii) They need only one man to operate and carriage to another place.
- (iii) They are very useful in the initial stage of fire.

(e) The disadvantages of these extinguishers are:-

- (i) The use is limited as the duration of the working of the extinguishers is approximately one to two minutes.

- (ii) The cost of these extinguishers is prohibitive.
- (iii) These extinguishers require constant care and careful maintenance.

16. **Stirrup Pumps.** The stirrup pump is an excellent piece of first aid firefighting equipment designed for use on small fire. It is very useful in localising and controlling fires with limited water supplies. Water spray from this equipment may be used on small fires for cooling the combustible material or the surrounding of scene of fire. It is generally operated by a team of four members but in an emergency a team of two members can also operate it effectively. The water jet produced by this pump can hit the ground at a distance not less than 9 meters from the nozzle. The consumption of water is about 1 to 1-1/2 gallons per minute. The spray produced by this pump can reach 15 to 20 feet away from the nozzle with water consumption $\frac{3}{4}$ gallons per minute.

17. **Bucket.** Buckets are ideal for storing water and sand for fighting small fires. They could be easily carried by one person, from one place to another.

18. **Fire Beaters/Hooks.** Beaters made of wire net in a rectangular shape and hooks made of iron fitted on bamboo poles are ideal for separating the burning and unburnt combustible material, and extinguishing by beating the small fires.

CONCLUSION

19. It therefore extremely essential for all to be aware of the causes of fires and how to prevent fires or carryout firefighting in homes and public places.

LESSON PLAN : DM 4
TRAFFIC CONTROL DURING NATURAL DISASTERS
UNDER POLICE SUPERVISION

Period	-	One
Type	-	Lecture
Code	-	DM 4
Term	-	III (SD/SW)

Training Aids

1. Computer Slides, Charts, Pointer, Black Board & Chalk.

Time Plan

2.	(a)	Introduction	-	05 Min
	(b)	Responsibilities of Traffic Police in Disaster Management	-	10 Min
	(c)	Employment of NCC Cadets under Traffic Police	-	20 Min
	(d)	Conclusion	-	05 Min

INTRODUCTION

3. Disaster causes substantial damage to life and property and its impact, effects life beyond the boundaries of one state. To avoid this chaos, due to breakdown of command and control and general law and order effected by lack of or no communication means, it is necessary that systems and organisations are set in place, to ensure that evacuation and subsequent reconstruction can be carried out smoothly. The major confusion is caused, due to movement of men and transport moving out to secure areas and of over jealous volunteers rushing in to help. Thus police in general and traffic police in particular, play an important role in a disaster management loop.

4. NCC cadets are a trained work force which can be utilized to assist the civil authorities during such period, where the civil authorities are short on trained personnel. However, for the cadets to be usefully employed, it is important to educate them on the role of traffic police during such situations.

AIM

5. To acquaint the NCC Cadets about the Traffic Control during Natural Disasters under Police Supervision.

PREVIEW

6. The lecture will be conducted in following parts :-
 - (a) Part I - Responsibilities of Traffic Police in Disaster Management
 - (b) Part II - Employment of NCC Cadets under Traffic Police.

**PART I : RESPONSIBILITIES OF TRAFFIC POLICE
IN DISASTER MANAGEMENT**

7. The Traffic Police is responsible for following actions during a natural disaster:-
- (a) To ensure smooth flow of all types of traffic in a disaster situation.
 - (b) To Provide adequate safety and security to the VIPs/protected persons and the common people affected by the disasters.
 - (c) To assist in securing the property of people affected by a disaster.
 - (d) To assist in evacuation of the injured persons to the nearby hospitals on priority.
 - (e) To assist in crowd control at the affected place as well as at respective hospitals and to prevent riots, looting etc.
 - (f) To ensure all possible help to the fire service, medical and other paramedical personnel in handling the disaster.
 - (g) To help in ensuring proper access to the fire brigade, ambulances, VIPs and other functionaries authorised to visit the scene or to carry out the rescue/relief operations.
 - (h) To assist in cordoning of the area, to restrict movement of onlookers and other vehicular and pedestrian traffic.
 - (j) To assist in ensuring collection of intelligence on the possibility of such disasters.
 - (k) To ensure better liaison and co-ordination with official of Apex/Civic bodies and others responsible while handling the disasters.
 - (l) To assist in proper identification of the dead and injured.
 - (m) To carryout adequate mobile patrolling in and around the affected area.

**PART II : EMPLOYMENT OF NCC CADETS UNDER
TRAFFIC POLICE DURING NATURAL DISASTERS**

8. For employment of NCC cadets during Natural Disasters, proper SOPs will have to be made by the local CO / Gp Cdr, in consultation with the DDMA, under the guidelines issued by HQ DG NCC / the State NCC Dtes. One of the roles to be given to NCC cadets in the overall District Disaster Management is assistance to Traffic Police. The detailed modalities on employment and quantum of cadets to be employed etc will have to be worked out with the local police authorities. Responsibilities of local traffic police and where cadets can be employed during disaster management stage are as under:-

- (a) **Immediate Action.** On receipt of the information about any Disaster taking place, SP/Dy SP concerned shall rush to the spot immediately, with his quick reaction team equipped with adequate communication equipment, rescue material, protective gear, warning signs and contact numbers; assess the situation and inform the SSP about the situation SSP should arrange for additional force from local resources. **Some NCC cadets can form part of the group which goes for the immediate action.**
- (b) **Initial Law and Order.** Local traffic police shall rush to the spot with ropes, search lights and other items for maintaining law and order. **NCC Cadets can be incorporated with the local police personnel.**

- (c) **Cordoning.** The entire affected area shall be cordoned off and no collection of crowd be allowed there. **NCC Cadets can be used to cordon off affected areas.**
- (d) **Casualty Management.** The Traffic Police plays an important role in traffic control and guidance in the chain of evacuation of casualties as injured persons shall be evacuated to the nearby hospital by the PCR vans, ambulances and other modes of conveyance. **NCC Cadets can accompany the casualty or be employed as points man or liaison officer at hospitals.**
- (e) **Traffic Flow.** No traffic shall be allowed to pass through the affected areas and necessary diversion shall be made accordingly. **Diversion points can be manned by NCC cadets in co-ordination with traffic police.**
- (f) **Emergency Vehicle.** The local traffic police shall ensure clear passage for emergency vehicles until traffic arrangements are made. **NCC Cadets can be employed to check and ensure that only emergency vehicles are permitted to the right of way.**
- (g) **Rescue Services.** Help shall be provided to the rescue services and volunteers in all possible manner. This will include guiding the fire tenders, ambulances etc to the place of incident through a clear route. **NCC Cadets can be cooperated with rescue services and volunteers to guide and escorting duties.**
- (h) **Adequate Reserve.** Adequate force be kept at the scene of occurrence for traffic control. **NCC Cadets can form part of the reserve forces to aid traffic police.**
- (j) **Maintain Records of Incidents.** The entire scene of incident must be video graphed as early as possible with a view to reconstruct the scene of occurrence, during the course of investigation. **NCC Cadets can be employed to video graph and carryout tasks in maintaining of records of incidents.**

9 **Miscellaneous Points.**

- (a) The mock exercise of various Disaster Management Authorities and groups should be conducted from time to time. Cadets must participate in mock exercise to understand their role and drawbacks noted must be improved upon.
- (b) Following details should be available with all concerned authorities and all locations can be visited and details coordinated by the cadets and NCC authorities for it to be of use during disaster management.
- (i) List of vital installations and buildings falling in the jurisdiction of a district.
 - (ii) List of major hospitals/nursing homes, casualties and ambulances service functioning in the district.
 - (iii) List of licensed Blood Banks.
 - (iv) Availability of heavy duty cranes.
 - (v) List of persons/agencies having earth moving/rescue equipments.
 - (vi) Important telephone numbers for disaster management authorities/ groups.
 - (vii) List of Fire Static water tanks.
 - (viii) List of Officials of Home Guard and Civil Defence and NCC Directorate.

- (ix) List of NGOs/Voluntary organization to be contacted at the time of disaster.
- (x) List of colleges and schools falling in the sector.
- (xi) List of big temples, Gurudwaras, Masjids and Churches situated in district.
- (xii) List of market associations.

CONCLUSION

10. NCC cadets being a well-trained force can contribute immensely in providing necessary assistance to Traffic Police during disasters. However, it must be ensured that the NCC cadets are not employed on dangerous routes / areas and their security and safety must be kept in mind before employing them.

LESSON PLAN : DM 5
ESSENTIAL SERVICES AND THEIR MAINTAINENCE

Period	-	One
Type	-	Lecture
Code	-	DM 5
Term	-	III (SD/SW)

Training Aids

1. Computer Slides, Charts, Pointer, Black Board & Chalk.

Time Plan

2.	(a)	Introduction	-	05 Min
	(b)	Type of Essential Services	-	05 Min
	(c)	Maintaining Essential Services	-	25 Min
	(d)	Conclusion	-	05 Min

INTRODUCTION

3. The term 'Essential Services' means any public utility services, public safety or the maintenance of infrastructure and services which are necessary for the maintenance of daily life of the people and the non-availability of which would result in the infliction of grave / extreme hardship to the people.

AIM

4. To acquaint the NCC Cadets about Essential Services and their Maintenance.

PREVIEW

5. The lecture will be conducted in following parts:-
 - (a) Part I - Type of Essential Services and their Maintenance.
 - (b) Part II - Role of NCC Cadets in Maintaining Essential Services.

PART I : ESSENTIAL SERVICES AND THEIR MAINTENANCE

6. Essential services can be categorized as under:-
 - (a) Postal, telegraph or telephone services.
 - (b) Transport Services like rail, road, air and sea.
 - (c) Running of air / sea ports.
 - (d) Provision of water, electricity and sanitation services.
 - (e) Medical services and essential supplies.

- (f) Production and supply of essential commodities.
- (g) Running of government mint and security presses.

Type of Maintenance Required for Essential Services

7. These services are maintained by Govt at all cost. There are very rigid acts and provisions to ensure continuity of these services since, without them life in country will go out of gear. Very strict provisions in law exist against personnel going on strike, refusing to work overtime or any other conduct which is likely to result in cessation or substantial retardation of work in maintaining these services. At district level, each district is required to prepare in advance, contingency plans to tackle the likely disturbances in continuity of these services.

8. Medical.

- (a) Running of medical facilities and hospitals.
- (b) Providing nursing and first aid.
- (c) Immunisation of the population in relief camps.
- (d) Rescue of trapped persons and causality evacuation..
- (e) Disposal of dead bodies and carcasses.

9. Communication.

- (a) Maintenance of uninterrupted telecommunication through telephone services /tele fax, mobile phones, VHF transmitters etc.
- (b) Dissemination of information, monitoring media coverage and quelling of rumors.

10. Transport.

- (a) Maintenance of rail/road communications with special attention to:-
 - (i) Repairing damaged rail/ road network, as it directly relates to the delivering of relief supplies by vehicles.
 - (ii) Creating diversions of bypassing damaged sections of the roads.
- (b) Extent of containers that can be moved inland.
- (c) Availability of maintenance facilities and spare parts.
- (d) Measures for security of cargo in transit.

11. Infrastructure.

- (a) Infrastructure of roads and bridges, communications, water and electricity supply, sewerage and essential buildings such as schools/ colleges and health centres may be required to be rebuilt/ repaired.
- (b) Housing and rehabilitation.
- (c) For economic rehabilitation, funding and various new opportunities to be created, in addition to getting the destroyed stocks replenished, for restoration of livelihood.

12. **Miscellaneous.**

- (a) Provision of Military, Para Military assistance.
- (b) Speedy establishment of Control Room and deployment of human and material resources in a short time.

**PART II : ROLE OF NCC CADETS IN
MAINTAINING ESSENTIAL SERVICES**

13. Being qualified in First Aid, Basic Home Nursing, Signals and having developed leadership traits and learnt about Social Services, Civil Defence and Disaster Management, the cadets of NCC could assist in maintaining the following essential services and important tasks in any and every part of the country in following ways:-

- (a) As operators in Telephone Exchange.
- (b) As nurses in Hospitals or as links between doctors, nurses, patients and hospital technicians. They could also help in maintaining hospital discipline and security.
- (c) Assist in establishment and running of First Aid Centres.
- (d) Assist civil defence wardens in carrying out their duties.
- (e) Carry out neighborhood campaigns by motivating people to create self assistance groups.
- (f) Counter act gossip and rumors to restore the morale of the people.
- (g) Assist the civil authorities whenever feasible and to the best of ability. Some of the areas where cadets can help are:-
 - (i) Search for and rescue trapped people.
 - (ii) Salvage destroyed structures and property.
 - (iii) Distribution of relief material to the affected population for their temporary sustenance.
 - (iv) Coordinate the relief flow from out-side and ensure maximum coverage of territory in provision of relief stores, food and water avoiding wastage and duplication of work in the same area.
 - (v) Repair and restore essential services to enable rescue and relief work and for normalization of activities.

CONCLUSION

14. Maintenance of essential services during strikes or calamities an important task for the govt administration. NCC Cadets, being qualified in first aid, signals and having developed various leadership traits and social services / Civil Defence, can play an important role in maintaining the essential services.

LESSON PLAN : DM 6
ASSISTANCE DURING NATURAL/OTHER CALAMITIES :
FLOODS /CYCLONE/EARTHQUAKE/ACCIDENTS ETC

Period	-	One / Two
Type	-	Lecture
Code	-	DM 6
Term	-	I / II (SD/SW)

Training Aids

1. Computer Slides, Charts, Pointer, Black Board & Chalk.

Time Plan

2.	(a)	Introduction	-	05 Min
	(b)	Effects of Natural / Other Calamities	-	10 Min
	(c)	Assistance by NCC during Natural Calamities	-	20 Min
	(d)	Conclusion	-	05 Min

INTRODUCTION

3. India is a large land form with peculiarity of varied geographical features. It has many rivers flowing through it and is surrounded by sea on its three sides and the high mountain ranges to its North. Though this makes India unique it also brings along vagaries of climatic and weather changes and other geographical phenomenon. Floods, Cyclones, Earthquakes and Tsunamis have occurred in the country from time to time. These natural disasters cause unimaginable damage to people and property, devastating lives of large number of our countrymen. It is therefore imperative that management during natural disasters be given utmost importance.

AIM

4. To acquaint the NCC Cadets about the providing of Assistance during Natural Calamities.

PREVIEW

5. The lecture will be conducted in following parts:-
 - (a) Part I - Effects of Natural / Other Calamities Assistance Required.
 - (b) Part II - Assistance by NCC during Natural Calamities.

PART I : EFFECTS OF NATURAL /OTHER CALAMITIES
AND ASSISTANCE REQUIRED

Effects of Natural / Other Calamities

6. The major effects of natural calamities are:-
 - (a) Excessive loss of life / injuries due to burial of people.

- (b) Inundation of cities / towns / villages or the country side, displacing hundreds of people, making them homeless or migrate to safer places.
- (c) Marooning of villages / houses / people.
- (d) Destruction / Collapsing of houses / buildings in villages / towns.
- (e) Total disruption of all essential services like communications, electricity, water and health services.
- (f) Severe damage to road / rail network including damage to bridges.
- (g) Displacement / loss of domestic and wild animals.
- (h) Destruction of crop / livelihood.

Type of Assistance Required

7. The following types of assistances will be required during natural / other calamities:-.

- (a) Setting up of information centres / reactivation of tele services.
- (b) Re-establishment of road / rail communication.
- (c) Establishment of relief camps / shelters.
- (c) Casualty Evacuation & Rescue.
- (d) Establishment of Medical Camp and providing First Aid.
- (e) Establishment of Sanitation Services.
- (f) Establishment and distribution of Relief Material including food and water.
- (g) Carcass Disposal.
- (h) Patrolling and Liaison.
- (i) Searching for casualties / survivors of air crash accidents in remote areas.

PART II : ASSISTANCE BY NCC DURING NATURAL /OTHER CALAMITIES

8. The organisation for providing assistance during natural / other calamities will be the existing organisation of NCC. To carry out disaster rescue and emergency relief operations readily with utmost speed, the state ADG/DDG will be the decision maker, who will act autonomously, keeping DG NCC informed. The executors will be the Group Commanders / Unit Commanders who will maintain close liaison with the DDMA authorities.

Method of Providing NCC Assistance

9. Immediately on receiving any requisition for providing NCC assistance from the district authorities, the CO Unit / Group Commander will take following actions :-

- (a) Muster adequate number of SD/JD cadets along with the ANOs and PI Staff. All means of communication should be used for collection of cadets. The ANOs must ensure that their cadets are collected in the shortest possible time.
- (b) Organise various action groups of strength 20-30 cadets under an ANO and a PI

Staff.

- (c) Carryout proper briefing of the cadets about the impending task.
- (d) Allocate and handover the action groups to the various agencies for providing assistance.

10. **Creation of Groups.** The following groups of NCC cadets need to be created for providing assistance:-

- (a) **Traffic Control Group.** This group provides assistance to traffic police.
- (b) **Relief Group.** This group provides assistance to collect and distribute relief materiel such as food supply, cloth, kerosene, diesel, utensils etc and coordinate all the relief requirement of the other action groups.
- (c) **Shelter Management Group.** This group will be employed for establishment or looking after shelters and safe houses providing the evacuees' food, water and medication requirements. This group can also coordinate with the government authorities to ensure that health and nutrition facilities are available for the extra vulnerable groups, like women and children.
- (d) **Evacuation and Rescue Groups.** The members of this group have to be physically strong (both SD and SW), and should be trained in basic evacuation and rescue method. The members of this group should coordinate with state government to get facilities for rescue and evacuation in terms of rescue training. Rescue infrastructure and equipment.
- (e) **First Aid Medical Groups.** There should be equal number of JD/SD and JW/SW cadets in this group. Those with some knowledge of nursing will be preferable. The members will have to go through intensive training and drills for first aid medical reasonability.
- (f) **Sanitation Groups.** This group can consist of girl and boy cadets, who will look after the sanitation responsibilities both at the shelter as well as outdoors.
- (g) **Carcass Disposal Groups.** Rotting and undisputed carcasses create unhygienic conditions and have to be disposed off immediately. Their disposal becomes an extremely important task. The members of this group have to be psychotically and physically able to carry out this task and should have been medically protected. They will be imparted appropriate training for carrying out this task. If possible the Civil Defence Volunteers, members from the NSS\boys Scouts can be included in this group.

11. **Miscellaneous.**

- (a) **Command and Control.** The overall command and control of the operation rests with the Group Commander. The Group Commander constantly provides feedback to the ADG / DDG who will be monitoring this from the directorate. Group Commander is to nominate a unit to coordinate the operation with one or more flood/cyclone control liaison officers. Telephonic communication will be severely affected in the event of floods. Therefore it is imperative that alternate source of communications are identified and included in the operation.
- (b) **Honours and Incentives.** Undertaking task in the event of the natural / other calamities is voluntary and organisation driven. It is a service performed outside call of one's duty and therefore it requires due recognition. It is encouraging and stimulating to the NCC volunteers to be recognised by the media during their dedicated work. Therefore the

liaison officer must be in constant liaison with the local and national press and electronic media and wide coverage must be given.

CONCLUSION

12. Natural / other calamities which occur without much notice, cause excessive damage to people and property. However, if we are well organized and prepared, then the losses in human lives can be reduced by providing timely assistance to the needy.

LESSON PLAN : DM 7
SETTINGUP OF RELIEF CAMP DURING DISASTER MANAGEMENT

Period	-	One
Type	-	Lecture
Code	-	DM 7
Term	-	III (SD/SW)

Training Aids

1. Computer Slides, Charts, Pointer, Black Board & Chalk.

Time Plan

2.
 - (a) Introduction - 03 Min
 - (b) Criteria for Site Selection and Planning - 20 Min
 - (c) Specific Infrastructure Design Considerations - 15 Min
 - (d) Conclusion - 02 Min

INTRODUCTION

3. Relief measures in the aftermath of disasters cover search, rescue and evacuation, relief for livestock, clearance of debris, disposal of dead, control of fires, damage assessment and shelter for victims. Setting up of relief camps encompasses shelter provision as part of emergency relief operations and long-term rehabilitation plans. Shelter provision can differ in view of peculiarities of location, climatic conditions and availability of resources. Inevitably, there will be a need for siting temporary relief camps in the proximity of the affected settlements for which tents may be required.

4. The NCC cadets, as trained and organised youth, can contribute immensely for conditioning and preparing the locals, in mitigating affects of natural disasters by providing assistance in setting up of relief camps.

AIM

5. To acquaint the NCC Cadets about the Setting up of Relief Camps during Disaster Management.

PREVIEW

6. The lecture will be conducted in following parts:-
 - (a) Part I - Criteria for Site Selection and Planning.
 - (b) Part II - Specific Infrastructure Design Considerations.

PART I : CRITERIA FOR SITE SELECTION AND PLANNING

Criteria for Site Selection

7. **Social Needs.** In most circumstances the choice will be limited and any land meeting even minimum standards may be scarce. Once a site is located, it is wise to determine the reason

to select or reject and examine whether the reason (e.g. no water or because it floods in the monsoon) would exclude use by displaced people.

8 **Water.** The single most important site selection criteria is the availability of an adequate amount of water on a Term-round basis. A site should not be selected on the assumption that water can be acquired merely by drilling, digging or hauling. Where water is readily available, drainage often becomes the key criterion. For effective drainage therefore, the entire site should be located above flood level at a minimum of three meters above the water table, preferably on a gently sloping area. Marshes or areas likely to become marshy or soggy during the rainy season should be avoided. The watershed of the area may be a consideration.

9 **Open Space.** The site must provide a sufficient amount of usable space for the displaced population. WHO recommends a minimum of 30 square meters per person, plus the necessary land for communal and agricultural activities and livestock. Of this, 3.5 square meters is the absolute minimum floor space per person in emergency shelters. Since there is always the possibility that more people may arrive, the site should be large enough to allow for major expansion. If the population has been displaced due to civil strife, the site should be removed from areas of potential conflict.

10. **Accessibility.** The site must be accessible by vehicles and close to communication links, sources of supplies and services such as food, cooking fuel, shelter material, and national community services.

11. **Environment.** The area should be free of major environmental health hazards, potential diseases and harmful insects such as mosquito and tsetse fly. Climatic conditions should be suitable for habitation throughout the Term.

12. **Soil and Ground Cover.** The soil should allow for water absorption and the retention of human waste. Rocky or impermeable sites should be avoided. If possible, land suitable for vegetable gardens and small scale agriculture should be selected for the site.

13. **Land Rights.** The land should be exempt from ownership rights or grazing and other uses by local population. Any use of the land must be based on formal legal arrangements in accordance with the laws of the country.

14. **Transit Centre.** There may be a need to set up a reception or transit centre, through which displaced people pass on the way to a long-term settlement site. These centres must have the same considerations as those relevant to long-term settlements.

Site Planning

15. At the onset of an emergency, the immediate provision of essential goods and services is more important than, efforts to change the way people have already arranged themselves. The important aspects are:-

- (a) Site planning should take potential need for expansion into account.
- (b) Site planning should first consider the characteristics and needs of the individual family and reflect the wishes of the community as much as possible.
- (c) A 'displaced-persons' settlement is not a natural community. Particular care will be required to ensure that special needs are met.
- (d) The overall physical layout of a site, as well as other aspects of the site, should reflect a decentralised community-based approach focusing on family, village or ethnic group.

PART II : SPECIFIC INFRASTRUCTURE DESIGN CONSIDERATIONS

16. **Physical Layout.** The basic principle of any physical layout of a camp is that it should be organised into small community units. The location of centralized services will depend on the

specific situation and in particular the space available. Warehouses should be located near the administrative office for security reasons.

17. **Shelters.**

(a) Shelter must provide protection, space to live and store belongings, privacy and emotional security. Shelter is one of the most important determinants of general living conditions and is often one of the largest items of non-recurring expenditure. Neither pre-fabricated buildings nor specially developed emergency shelter units have proved effective in displaced persons emergencies. Both are ineffective due to their inappropriateness, high unit cost, transport problems, and inflexibility. Emergency shelter arrangements will already have been constructed before such systems can arrive. For similar reasons, tents are often not an effective means of providing shelter. If a continued high density of occupation is unavoidable, fire resistant materials may be needed. Housing should meet the cultural and social requirements of a displaced person's home.

(b) Material and design should meet the minimum technical standards for the different local seasons. Roof material must be strong enough to withstand damage by the sun, rain, snow and winds. Raised flooring is required in areas of high rainfall. Wall material must afford privacy and protection from the elements. If the site lies in a hazard-prone area, the design of buildings and their siting should conform to hazard-resistant criteria. In buildings where cleanliness and hygiene are particularly important, the floor should be of cement or at least washable.

18. **Roads and Pathways.** The site should be accessible from other sites and contain all-weather roads and pathways connecting the various areas and facilities.

19. **Administrative and Community Services.** At the onset of an emergency, it may be difficult to foresee all the administrative and community services likely to be required. Therefore, where adequate space is available, free areas must be allocated for future expansion of these services. The following administrative and community services are often required:-

(a) **Likely to be Centralised.**

- (i) Camp administrative office.
- (ii) Essential services co-ordination offices (health care, water supply).
- (iii) Tracing services (Overhauling, repair facilities etc).

(b) **Likely to be Decentralised.**

- (i) Bathing and washing areas.
- (ii) Community services (health centres, social service centres).
- (iii) Supplementary feeding centres.
- (iv) Education facilities.
- (v) Institutional centres (such as for the disabled or unaccompanied old, infirm and children).

20. **Latrines.** While water requirements often determine site selection, sanitation requirements can dictate the site layout. If latrines are used there should be at least one for every 20 persons. To avoid contaminating water sources, latrines should have an effective drainage system that is easy to repair, both for rainwater and waste water.

21. **Water Distribution.** Water will often be pumped from the source to an elevated point in order to allow gravity feed distribution.

CONCLUSION

22. Emergency shelters, including communal buildings, should be built by the displaced people themselves provided adequate organization and material support is given. This will help to ensure that housing will meet their particular needs. Work by displaced people will reduce their sense of dependence and can cut costs considerably.

LESSON PLAN : DM 8
COLLECTION & DISTRIBUTION OF AID MATERIAL

Period	-	One
Type	-	Lecture
Code	-	DM 8
Term	-	III (SD/SW)

Training Aids

1. Computer Slides, Charts, Pointer, Black Board & Chalk.

Time Plan

2.	(a)	Introduction	-	05 Min
	(b)	Nature of Aid Material	-	15 Min
	(c)	Collection and Distribution of Aid Material	-	15 Min
	(d)	Conclusion	-	05 Min

INTRODUCTION

3. Collection and distribution of aid material are essential steps in the loop of demand and supply. The normal items reach the common man from the manufacturers through a well laid out delivery systems where in many organizations work as a well oiled machine. However on the occurrence of a disaster, this chain is completely broken down. Till this chain is not re-established, there is an urgent need to create alternate methods of collection and distribution of emergency articles so that they reach the effected persons.

AIM

4. To acquaint the NCC Cadets about the Collection and Distribution of Aid Material.

PREVIEW

5. The lecture will be conducted in following parts:-
 - (a) Part I - Nature of Aid Materials.
 - (b) Part II - Collection and Distribution of Aid Materials.

PART I : NATURE & SOURCE OF AID MATERIAL REQUIRED

6. The nature and type of aid material required can be categorised as under:-
 - (a) **Personal Clothing and Bedding Items.** Personal items such as clothing for personal use, bedding, rain coats, blankets and other articles of bedding and shoes.
 - (b) **Medical and Life Saving Equipment.** In the medical field, items like, medicines and life saving drugs, provision of doctors and nursing staff, ambulances, mobile hospitals and equipment for immediate medical needs.

(c) **Housing and Shelters.** As a number of people are likely to become homeless due to damage to building and shelters. There would be a need for housing facility including shelter provision such as tentage pre-fabricated huts, water proof material for temporary overhead protection.

(d) **Transportation.** Restoration of the transport system may take a very long time. Thus transport to move effected personnel to safer areas must be catered for by govt organisations and NGOs.

(e) **Debris Clearing Equipment.** The affected area require to be cleaned off debris. Equipment varying from mechanical machines to hand operated equipment will be required . Some items which may be required are cranes, bulldozers, tippers, shovels, pick axes, drills and hand drills and ordinary hammers.

(f) **Animals and Live Stock.** The disaster also effects livestock. It will also require immediate fodder and rehabilitation. This is important as major outbreak of epidemics are due to death of animals.

(g) **Disposal of the Dead.** This aspect needs speedy attention, the recovery of bodies, identification, handing over to relatives, maintaining of proper records and eventually ensuring that all the dead get disposed with dignity. Equipment and personnel relating to the same will be required.

(h) **Communication.** The entire command and control is based on speedy restoration of communications so that adequate nets on radio sets can be established and telephone line are restored at the earliest.

(j) **Food, Water and Cooking Facilities.** Food is the major requirement of the effected population. Food needs to be provided so that they can survive. Some of the things which will be required are survival food kits which may be air dropped or given via road or water routes. Other items are dry rations, fresh vegetables, pre - cooked food packages, water in dispensers and bottles for individuals and in water bouser for cooking and general use.

(k) **Electricity and Lighting Facilities.** Darkness and destruction are enough to demoralise and kill the spirit of survival. Therefore provision of lighting facilities is very essential. Some items like lanterns, patromaxes, gas lights need to be provided and all efforts must be made towards restoration of electricity at the earliest.

7. **Sources of the Items.** Whenever there is a disaster, in addition to the Government Organisations, a large number of NGOs and more so, the general public flows with generosity and stores are received from a large number of agencies, such as :-

- (a) Central Government Organisations including Defence Services.
- (b) State Government Organisations.
- (c) Non Government Organisations (NGOs).
- (d) Educational Institutions.
- (e) Social Welfare Organisations.
- (f) Resident Welfare Organisations.
- (g) Red Cross.
- (h) International Organisations, like WHO etc.

- (j) Individuals.

PART II : COLLECTION AND DISTRIBUTION OF AID MATERIAL

8. **Collection.** Government Agencies and Non Government Organisations (NGOs) are the primary collection agencies. All items need to be collected and sifted as per the requirement/groups and categories. It has been often observed that a large number of items get collected but do not reach the effected persons due to lack of planned and coordinated collection and distribution system. The following need to be kept in mind:-

- (a) Establish collection centres at various locations of the state keeping in mind the provisioning capabilities of the locality.
- (b) Collect items as per categories initially itself to avoid wasting time in sifting and repacking.
- (c) Perishable items of food to be collected at special centres to ensure speedy transportation.
- (d) Do not collect items which are not required.
- (e) Ensure that the next stage/ centre of collection is ready to accept these items and proper records are maintained of the arrival and dispatch of packages.
- (f) Sift the packages as per priority of requirement.
- (g) Ensure life saving drugs is routed through different collection and distribution channels to avoid delay.

9. **Distribution.** The distribution system is the most essential process for the timely receipt of emergencies items during and after a disaster. The entire process of rehabilitation depends on this system. Initially it is recommended to make the Public Distribution System (PDS) as the base for the distribution as it is a already available functional chain of supply. Additional manpower may be required and minor adjustment will also be required keeping in mind the situation on ground. However the following needs to be also done:-

- (a) Establish distribution system as per the concentration of population and the established refugee camps and rehabilitation centres.
- (b) NGOs should carryout work in consultation with government agencies to ensure that proper flow of required material is received by all the people.
- (c) Individual organisation must also work in consultation with government organisation as per the priority of the items to be distributed.
- (d) Ensure that adequate items are distributed and records are maintained and given as per the available details of family members. Initially minimum requirement should be provided per family which can be subsequently increased with more availability of items.
- (e) If the collection process has been properly carried out it will save time and the material would reach the effected persons with speed.
- (f) The entire area should be divided into grids during rehearsal stage and adequate facilities should be put in place during this stage for use at a later date.
- (g) The bulk breaking of the items would have already been carried out at the collection stage. However, if for the limitation of transportation it is required to be repacked, it must be done speedily.

(h) Major essential items can be moved by air, road, rail, waterways or a combination of any of these means depending on the ground situation.

8. **Role of NCC Cadets.** NCC cadets can play an important role in the collection and distribution of aid material. Some of the tasks which can be performed by NCC cadets are as under:-

(a) **Collection Stage.**

(i) The Cadets must be incorporated in the process at the planning stage itself to identify the sources, the areas of importance and the agencies which they are likely to work with.

(ii) Cadets can help at the time of collection and help in maintaining records.

(iii) Help in the sifting of articles and bulk breaking and packaging.

(iv) Help in dispatch of items by various means.

(v) NCC can establish their own collection and distribution centres as they are closely associated with schools and colleges all over the country and even in the remotest areas of our country. These can be opened at unit/ group level.

(vi) NCC is working and coordinating with government at the central and also at the state and district level and thus by their disposition they are ideally suited for a parallel net work with other organisations.

(b) **Distribution.**

(i) Can be co-opted with the PDS system.

(ii) Work along with NGOs or other organisations.

(iii) Work independently in the chain of NCC collection and distribution system.

(iv) Work along with Defence Forces, who are major contributors in crisis management.

(v) Operate and man various posts established for escorting and guiding delivery agents with adequate signal communications.

CONCLUSION

9. Collection and distribution of aid material is an essential activity in Disaster Management. The NCC with its vast potential and strength can contribute immensely in this activity, by proper coordination with the district authorities.

INDEX**SOCIAL AWARENESS AND COMMUNITY DEVELOPMENT**

<u>Ser No</u>	<u>Lesson Code</u>	<u>Subject</u>	<u>Cat</u>	<u>Page No</u>
1.	SA 1	Basics of Social Service and Its Need	SD / SW	158
2.	SA 2	Rural Development Programmes - MNREGA, SGSY, NSAP etc	SD / SW	162
3.	SA 3	NGOs Role & Contribution	SD / SW	168
4.	SA 4	Contribution of Youth towards Social Welfare	SD / SW	171
5.	SA 5	Family Planning	SD / SW	173
6.	SA 6	Drug Abuse and Trafficking	SD / SW	176
7.	SA 7	Civic Responsibilities	SD / SW	179
8.	SA 8	Causes & Prevention of HIV / AIDS and Role of Youth	SD / SW	181
9.	SA 9	Counter Terrorism	SD / SW	188
10.	SA 10	Corruption	SD / SW	192
11.	SA 11	Social Evils - Female Foeticide, Dowry, Child Abuse / Trafficking	SD / SW	196
12.	SA 12	RTI & RTE	SD / SW	202
13.	SA 13	Traffic Control Organisation and Anti Drunken Driving	SD / SW	206
14.	SA 14	Provisions of Protection of Children from Sexual Harassment Act 2012	SD / SW	209

LESSON PLAN : SA 1
BASICS OF SOCIAL SERVICE AND ITS NEED

Period	-	One
Type	-	Lecture
Code	-	SA 1
Term	-	I (SD/SW)

Training Aids

1. Computer, Projector, Charts, Pointer, Black Board & Chalk.

Time Plan

- | | | | | |
|----|-----|--------------------------------|---|--------|
| 2. | (a) | Introduction | - | 05 Min |
| | (b) | Basics of Social Service | - | 15 Min |
| | (c) | Weaker Sections of our Society | - | 15 Min |
| | (d) | Conclusion | - | 05 Min |

INTRODUCTION

3. The term 'Social Service' is defined broadly as, the provisions made by governmental or voluntary efforts to meet income maintenance, medical care, housing, education and recreational needs and provisions, for the care and protection of recognised special groups. The origin of social service is ancient, stemming from the tenets of the Judaco- Christian teachings. The modern institutional service took shape with the impact of the industrial revolution upon family and community life , substituting as it did an industrial for an agrarian economy, urban living for rural living and creating dependence upon the wage system as a means of livelihood.

4. Social service characterises a formalised way of helping people, to help themselves. It is based on the reorganization of variations in individual capability and variations in the social structure . The objective is to help the individual to utilise his capability for his own welfare and for that community.

AIM

5. To acquaint the cadets about the Basics of Social Service, Weaker Sections of our Society and their Needs.

PREVIEW

6. The lecture will be conducted in following parts:-

(c)	Part I	-	Basics of Social Service.
(d)	Part II	-	Weaker Sections of our Society and their Needs.

PART I : BASICS OF SOCIAL SERVICE

7. **Methods.** There are generally three accepted methods identified for conduct of social service which are as under:-

- (a) **Social Case Work.** This aims to help the individual make maximum use of the established community, through understanding the individual in his total situation.
- (b) **Social Group Work.** It seeks to help the individuals utilize their fullest capacity for their own welfare and for the welfare of the group as a whole, through understanding of the behaviour of individuals in a group setting.
- (c) **Community Organization.** It attempts to help groups of individuals or groups of agencies to work together so that their combined efforts will be useful for the social welfare of the whole community.

8. **Types of Social Service Activities.** The various types of social service activities which can be undertaken are as under:-

- (a) Education.
- (b) Family Welfare, Medical Care, Family Planning and Nutrition.
- (c) Provision of Water and Cooking Fuel, Roads, Electricity and Sanitation.
- (d) Old Age Support Systems.
- (e) Employment.
- (f) Social Assistance, Social Security and Care & Protection.
- (g) Housing and Rehabilitation.
- (h) Recreation, Sports and Social activities.

PART II : WEAKER SECTIONS OF SOCIETY AND THEIR NEEDS

9. **General.** India is still divided into many endogamous groups, or castes and sub-castes, as a result of centuries of practicing a form of social hierarchy called the caste system. The traditional caste system, leads to severe oppression and segregation of the lower castes and other weaker sections and limits their access to various freedoms e.g, education and employment. After independence the constitution of India included safeguards for suppressed and other backward classes. The Indian constitution prohibits any discrimination based on religion, race, caste, sex and place of birth. But, while providing equality of opportunity for all citizens, the constitution also contains special clauses to ensure reservation, 'for the advancement of any socially and for the educationally backward classes of citizens or for the Scheduled Castes and the Scheduled Tribes'.

10. **Classes of Society.**

- (a) **Scheduled Caste and Scheduled Tribes.** Scheduled Castes and Scheduled Tribes are communities that are accorded special status by the Constitution of India. These communities were considered "outcastes". These castes and tribes have traditionally been relegated to the most menial labour with little possibility of upward mobility and are subject to extensive social disadvantage and discrimination. The Scheduled Caste people are also known as Dalits and the Scheduled Tribes people as Adivasis. Mahatma Gandhi used the terms Harijans and Girijan, for SC and ST respectively. According to 2001 census,

population of SC and ST is approximately 16% and 8% of India's total population respectively.

(b) **Other Backward Classes (OBCs)**. These classes are a group of sub castes which are socially and educationally backward while still having a higher status than scheduled castes or scheduled tribes. As of 2006 approximately 2300 communities are listed backwards. Central and all state governments are enjoined to ensure their social and educational development.

11. **Needs of the Weaker Sections.**

(a) **Education**. Education is the basic need of the weaker sections. The right approach would be to provide all weaker sections, proper primary education, to prevent them from dropping out of school and making them 'natural competitors' and to give scholarships at higher level. There is an urgent need to increase the number of educational institutes. Some measures which can contribute in this are:-

(i) At the village level, opening of schools which impart basic education coupled with the vocational skill that can be taught with the naturally available resources e.g. basket weaving, painting printing, tailoring, embroidery, pottery, music, dance, etc will help in achieving self-sufficiency. Specially trained teachers should be adequately compensated, so that talented people do not hesitate to go to villages.

(ii) Schools should also educate the villagers on moral values, hygiene, first aid, family planning, budgeting, savings etc.

(iii) Villagers must be educated on the need for educating the girl child as she is the one responsible in bringing up the future generations. She should therefore develop courage, self-confidence, competitive spirit and a sense of equality with boys.

(iv) Social evils such as the dowry system, child marriages and superstitions, should be taken up for discussion and their drawbacks be pointed out, so that they become events of history.

(b) **Employment**. Provision of land to landless and helping them in working out a life by providing softer loans for cultivations etc can take care of employment problems to some extent. Taking up of infrastructure projects will help in creating large number of jobs.

(c) **Reservation in Educational Institutions and Govt Jobs**. Reservations are intended to increase the social diversity in campuses and workplaces by lowering the entry criteria for certain identifiable groups who are grossly underrepresented in proportion to their number in general population. Reservation is a term used to describe policies whereby a portion of jobs, positions or academic seats are set aside or reserved for a given group. Government has taken initiatives on a large scale by providing reservations in different fields such as government jobs, educational institution and other such government aided and semi-govt institutions, to help the SCs, STs and OBCs. A certain percentage of seats are reserved for sections so that the discrimination against them can be reduced and they will be provided with equal opportunities to work and grow. The Constitution lays down that 15% and 7.5% of vacancies in government-aided educational institutes and for jobs in the government /public sector are reserved as quota for the SC and ST respectively. Although originally supposed to last for 10 years, the reservation system has continued till date and now applies to higher education and legislative offices also. Currently 22.5% of the seats in

higher education institutes under the Central Government are reserved for SC and ST, and 27% for OBCs.

12. **Contribution of NCC Cadets.** Our NCC Cadets are from every nook and corner of India. We must therefore utilise this huge potential of eager, helpful, energetic, educated and talented cadets, to achieve our aim of imbibing values and skills amongst the weaker sections of our society which will make themselves self-sufficient and confident. They will cease to be a drain on the resources of India and will become valuable contributors to our economy.

CONCLUSION

13. There is no doubt that the interests of the weaker sections need to be protected and their legitimate needs fulfilled so that we can have a just and fair society where the under privileged are not discriminated against and no section lags behind the other.

LESSON PLAN : SA 2
RURAL DEVELOPMENT PROGRAMMES

Period	-	One
Type	-	Lecture
Code	-	SA 2
Term	-	I (SD/SW)

Training Aids

1. Computer, Projector, Charts, Pointer, Black Board & Chalk.

Time Plan

2.	(a)	Introduction	-	05 Min
	(b)	What is Rural Development and Its Need	-	15 Min
	(c)	Rural Development Programmes in India	-	15 Min
	(d)	Conclusion	-	05 Min

INTRODUCTION

3. Every country has a population which is divided into two sections, the urban and the rural. Urban people are those who live in urban areas where everything is available, particularly the basic needs like health care, education, water, electricity, telecommunication, roads, transports, railways etc. The areas where such facilities are not available at all or are not adequate, are known as rural areas. For a country to develop, it is very essential that the country progress as a whole and not only in the urban areas. As we are aware, India is one of the largest democracies in the world and fast emerging as a world power, but it has not yet reached the stage of a fully developed country, due to the huge gap between its people living in urban and rural areas.

AIM

4. To acquaint the cadets about the Rural Development Programmes in India.

PREVIEW

5. The lecture will be conducted in three parts as under:-
 - (a) Part I - What is Rural Development and its Need.
 - (b) Part II - Important Rural development Projects in India.

PART I : RURAL DEVELOPMENT AND ITS NEED

6. Rural development is a process that aims at improving the quality of life and standard of living of the people in the rural areas. It may be defined as overall development of rural areas to improve the quality of life of rural people. It is an integrated and sustainable process of improvement of the rural areas, which includes social, economical, political and spiritual development of the poorer sections of the society.

7. Rural development encompasses the following:-
- (a) Finding the ways to improve the rural lives, with participation of the rural people themselves, so as to meet the required need of the rural area.
 - (b) It covers the following activities:-
 - (a) Education.
 - (b) Health.
 - (c) Banking.
 - (d) Roads.
 - (e) Water and Electricity.
 - (f) Employment.
 - (g) Small Scale Industries and Agricultural Products.
 - (h) Crop, Poultry and Animal Farming.
 - (j) Rural Tourism.

Need For Rural Development

8. India is primarily an agro based economy. 70 % of the country's population lives in rural areas with no or very little facilities. In order to become a global power, we need to develop our rural areas. The need to develop rural areas can be summarized as under:-

- (a) To bridge the urban – rural divide.
- (b) To bridge the economic gap between incomes of rural – urban population.
- (c) To control or reduce mass migration of population from rural to urban areas.
- (d) To have equitable distribution of resources and development activities.
- (e) To create more job opportunities.
- (g) To empower the rural population.

9. **The Ministry of Rural Development.** In order to have a proper mechanism for rural development in the country, The Ministry of Rural Development has been created at the centre. It includes two departments which plan and execute its plans. These are:-

- (a) Department of Rural Development.
- (b) Department of Land Resources.

10. **Aims of The Ministry of Rural Development.** These are:-

- (a) Providing livelihood opportunities to those in need, including women and other vulnerable sections and food security to rural Below Poverty Line (BPL) households.

- (b) Providing for the enhancement of livelihood, security of households, in rural areas by providing at least 100 days of guaranteed wage employment, in every financial year, to every household.
- (c) Provision of all-weather rural connectivity to unconnected rural habitations and up gradation of existing roads to enable them to market access.
- (d) Providing basic housing and homestead to BPL households in rural areas.
- (e) Providing social assistance to the elderly, widow and disabled persons.
- (f) Providing urban amenities in rural areas for improvement of quality of life.
- (g) Capacity development and training of rural development functionaries.
- (f) Promoting involvement of voluntary agencies and individuals for Rural Development.
- (g) Restoring lost or depleted productivity of the land. This is done through watershed development programmes and initiating effective land reform measures for providing land to the landless rural poor.

PART II : IMPORTANT RURAL DEVELOPMENT PROGRAMMES IN INDIA

MGNREGA

11. On 2nd Feb, 2006 'National Rural Employment Guarantee Act'2005 (NREGA) was launched and in 2010 it was renamed as the Mahatma Gandhi National Rural Employment Guarantee Act (MGNREGA). It was the first ever law internationally, that guarantees wage employment in an unprecedented scale. MGNREGA aims at enhancing livelihood security of households in rural areas of the country, by providing at least one hundred days of guaranteed wage employment in a financial year, to every household whose adult members volunteer to do unskilled manual work. To start with, 200 selected districts of the country were brought under it and within three years of its launch, MGNREGA was extended to all the districts of the country from 1st April 2008.

12. Unique features of the Act include:-

- (a) Time bound employment guarantee and wage payment within 15 days.
- (b) Incentive – disincentive structure to the state governments, for providing or not providing employment, as per demand.
- (c) Emphasis on labour intensive works prohibiting the use of contractors, and machinery.
- (d) Ensure the creation of durable community, social and economic infrastructure and assets in the rural areas.
- (e) The Act also mandates 33 per cent participation for women.

13. Over the years employment opportunities under MGNREGA have increased and during 5.49 crore household were provided employment in 2010-11. The average wage paid under MGNREGA has increased from Rs 65 in 2006-07 to Rs 100 in FY 2010-11. The Programme had a high workforce participation of marginalized groups like SC/ST (52 % in 2011) and women participation was 50% in 2012. About 9.88 crore bank and post office accounts have been opened to disburse wages directly to the workers' accounts. Of the total works were undertaken, 53% constituted water conservation, 22% rural connectivity and 9% land development.

Swarnajayanti Gram Swarojgar Yojna (SGSY)

14. This programme was launched in April, 1999. This is a holistic programme covering all aspects of self-employment such as organisation of the poor into self-help groups, training, credit, technology, infrastructure and marketing.

15. The objective of SGSY is to provide sustainable income to the rural poor. The programme aims at establishing a large number of micro-enterprises in the rural areas, based upon the potential of the rural poor. It is envisaged that every family assisted under SGSY will be brought above the poverty-line with in a period of three years.

16. This programme covers families below poverty line in rural areas of the country. Within this target group, special safeguards have been provided by reserving 50% of benefits for SCs/STs, 40% for women and 3% for physically handicapped persons. Subject to the availability of the funds, it is proposed to cover 30% of the rural poor in each block in the next 5 years. SGSY is being implemented by the District Rural Development Agencies (DRDAs) with the active participation of Panchayat Raj Institutions, the Banks, the line Departments, and NGOs. SGSY has been restructured as National Rural Livelihoods Mission (NRLM) and now renamed as 'Aajeevika'.

Jawahar Gram Samridhi Yojna (JGSY)

18. The critical importance of rural infrastructure in the development of village economy is well known. A number of steps have been initiated by the Central as well as the State Governments for building the rural infrastructure. The public works programme have also contributed significantly in this direction.

19. Jawahar Gram Samridhi Yojna (JGSY) is the restructured, streamlined and comprehensive version of the erstwhile Jawahar Rozagar Yojana. Designed to improve the quality of life of the poor, JGSY has been launched on 1st April, 1999. The primary objective of the JGSY is the creation of demand driven community village infrastructure including durable assets at the village level and assets to enable the rural poor to increase the opportunities for sustained employment. The secondary objective is the generation of supplementary employment for the unemployed poor in the rural areas. The wage employment under the programme shall be given to Below Poverty Line (BPL) families.

20. JGSY is implemented entirely at the village Panchayat level. Village Panchayat is the sole authority for preparation of the Annual Plan and its implementation.

Indira Aawas Yojna (IAY)

21. IAY is the flagship rural housing scheme which is being implemented by the Government of India with an aim of providing shelter to the poor below poverty line. The Government of India has decided that allocation of funds under IAY (Indira Awas Yojna) will be on the basis of poverty ratio and housing shortage.

22. The objective of IAY is primarily to help construction of new dwelling units as well as conversion of unserviceable kutcha houses into pucca / semi-pucca by members of SC/STs, freed bonded labourers and also non-SC/ST rural poor below the poverty line by extending them grant-in-aid.

23. IAY is a beneficiary-oriented programme aimed at providing houses for SC/ST households who are victims of atrocities, households headed by widows/unmarried women and SC/ST households who are below the poverty line. This scheme has been in effect from 1st April, 1999 and since inception of scheme about 272.83 lakh houses have been constructed. December, 2000, a 100 % centrally sponsored scheme namely Pradhan Mantri Gram Sadak Yojana (PMGSY) was launched with the objective of providing connectivity by all weather roads to about 1.60 lakh unconnected habitations with population of 500 persons and above (250 persons and above in

respect of hill States, the tribal and the desert areas) through good all-weather roads in the rural areas by the end of Tenth Plan Period (2007) Upto January,2012, a total of 42,531 habitations have been connected out of 63,940 habitations to be connected and works for 58,387 habitations sanctioned.

National Social Assistance Programme (NSAP)

24. The National Social Assistance Programme (NSAP) was launched in 1995-96 The NSAP then comprised of the National Old Age Pension Scheme (NOAPS), National Family Benefit Scheme (NFBS) and National Maternity Benefit Scheme (NMBS). On 1st April, 2000 a new scheme known as 'Annapurna Scheme' was launched. This Scheme aimed at providing food security to meet the requirement of those senior citizens who, though eligible had remained uncovered under the NOAPS. In February 2009 two new Schemes namely, Indira Gandhi National Widow Pension Scheme (IGNWPS) and Indira Gandhi National Disability Pension Scheme (IGNDPS) have been introduced under NSAP. The major benefits under these various schemes are as under:-

(a) Under Annapurna Scheme 10 kgs of food grains per month is provided free of cost to the beneficiary.

(b) Under NOAPS, Rs 75 per month was being provided per beneficiary to destitute who are 65 years of age or above. However, with effect from 01 Apr 2011, the eligibility age for old age pension under IGNOAPS has been reduced from 65 years to 60 years and the amount of pension has been raised from Rs 200 to Rs 500 per month for those who are 80 years or above.

(c) GOI approved a pension of ` 200 per month, per beneficiary to BPL widows in the age group of 40-64 years. Consequent upon the revision in age limit under IGNOAPS w.e.f. 01.04.2011, the upper age limit under IGNWPS was revised from 64 years to 59 years. Presently, widow pension under IGNWPS is provided to BPL widows in the age group of 40-59 years. It is estimated that during the year 2011-12, 29 lakh beneficiaries would be covered under the scheme.

(d) A pension of Rs 200 per month, per beneficiary is provided to disabled persons with severe or multiple disabilities between the age group of 18-64 years belonging to BPL families, under Indira Gandhi National Disability Pension Scheme(IGNDPS).

Pradhan Mantri Gram Sadak Yojana (PMGSY)

25. In December, 2000, a 100 % centrally sponsored scheme namely Pradhan Mantri Gram Sadak Yojana (PMGSY) was launched with the objective of providing connectivity by all weather roads to about 1.60 lakh unconnected habitations, with population of 500 persons and above (250 persons and above in respect of hill States, the tribal and the desert areas) through good all-weather roads in the rural areas by the end of (2007. Upto January, 2012, a total of 42,531 habitations have been connected out of 63,940 habitations which were to be connected and works for 58,387 habitations have been sanctioned.

Other Development Projects

26. Details of other rural development projects / schemes are as under:-

(a) **Sampoorna Grameen Rozgar Yojana (SGRY) 2001.** For providing additional wage employment and food security, alongside creation of durable community assets in rural areas.

(b) **National Food for Work Program (NFWP) 2004.** To provide additional resources apart from the resources available under the SGRY to 150 most backward districts of the country for generation of supplementary wage employment and provision of food security.

- (c) **Drought Prone Area Program (DPAP) 1974.** To tackle the special problems by those in drought areas.
- (d) **Desert Development Program (DDP) 1978.** To mitigate adverse effects of desertification.
- (e) **Integrated Wastelands Development Program (IWDP) 1990.** Projects sanctioned to the areas not covered under DPAP or DDP.
- (f) **Rajiv Gandhi National Drinking Water Mission (RGNDWM) 1991.** To provide safe drinking water to all villages, to maintain sources of drinking water in good condition and to give special attention for water supply to SCs and STs.
- (g) **Central Rural Sanitation Program (CRSP) 1986.** For improving the quality of life of rural people and providing privacy and dignity to women.

CONCLUSION

27. It is very important in a large and democratic country like India, all welfare schemes and other administrative benefit reach every citizen. For this to happen, it is important that an effective administration set up is available at every level from Central Government to Gram Panchayat. Of course, honest and corrupt-free implementation of projects will decide the success of the system. As the future citizens of India, we need to be aware of the system and responsibilities of each official in the administrative set up so that we can contribute in our own way for the development of our society.

LESSON PLAN : SA 3
NGOs ROLE & CONTRIBUTION

Period	-	One
Type	-	Lecture
Code	-	SA 3
Term	-	II (SD/SW)

Training Aids

1. Computer, Projector, Charts, Pointer, Black Board & Chalk.

Time Plan

2. (a) Introduction - 05 Min
- (b) What are NGOs - 15 Min
- (c) NOGs Contribution to Society - 15 Min
- (d) Conclusion - 05 Min

INTRODUCTION

3. The term 'Social Service' is defined broadly as, the provisions made by governmental or voluntary efforts to meet income, maintenance, medical care, housing, education and recreational needs and provisions, for the care and protection of recognised special groups.

4. Social service characterises a formalised way of helping people, to help themselves. There are a large number of Non Governmental Organisations (NGOs) which are actively involved in social service today.

AIM

5. To acquaint the cadets about NGOs Role and Contribution to Society.

PREVIEW

6. The lecture will be conducted in following parts:-
 - (a) Part I - What are NGOs.
 - (b) Part II - NGOs Contribution to Society.

PART I : WHAT ARE NGOs

7. **Non-Government Organisations**

(a) These are organisations which are controlled by members of society, who form a group or groups and, work towards social welfare and nation building. People with common objective and aspirations, together make organisations called Non-Government Organisation (NGOs) and get them registered.

(b) An NGO is a non-profit group or association that acts outside of institutionalised political structures and pursue matters of interest to its members by lobbying, persuasion, or direct action.

(c) NGOs firstly make survey of various problems, collect information about them, organize various demonstrations, give speeches and wherever action needs to be taken, they take with full vigour. They understand social problems, the causes, affects and create necessary infrastructure to overcome them.

(d) NGOs are primarily non-commercial. They collect funds both from people and the government. NGOs usually gain a portion of their funding from private sources. Major sources of NGO funding include membership dues, grant from international institutions or national governments and private donations.

8. **Types of NGOs.** NGOs can be of following types:-

- (a) **INGO.** It stands for International NGOs.
- (b) **BINGO.** Business oriented International NGOs.
- (c) **RINGO.** Religious International NGOs.
- (d) **ENGO.** Enviornmental NGO.

9. Some of the examples of important NGOs are:-

- (a) **Shri Niketan Yojna** - by Ravinder Nath Tagore.
- (b) **Seva Gram Yojna** - by Gandhiji.
- (c) **Gram Yojna** by Vinoba Bhave.
- (d) **Child Relief and You.**
- (e) **Helpage India.**
- (f) **People for Animals (PFA) & Society for Prevention of Cruelty to Animals (SPCA).**
- (g) **International Red Cross and Red Cresent Movement** are the world's largest group of humanitarian NGOs.

PART II : CONTRIBUTION OF NGOs

10. Contribution by NGOs could be in the following activities undertaken by them:-

- (a) Blood Donation.
- (b) Adult Literacy.
- (c) Anti Dowry Drive.
- (d) Anti Leprosy Drive.
- (e) Anti Drug Drive.

- (f) Tree Plantation.
- (g) Environmental Programmes.
- (h) Help in natural calamities such as Flood, Earth-quake.
- (j) Educating people about the ill-effects of AIDS and education for prevention of the same.
- (k) Family Planning Programmes.
- (l) Community Development Work.
- (m) Promotion of Social-equality.
- (n) Wildlife and Animal Care.
- (o) Human-rights.
- (p) Awareness Campaign.
- (q) Child Care.
- (r) Polio Eradication drive.
- (s) Providing schooling facilities especially in remote villages and rural areas.
- (t) Creating and providing health and hygiene infrastructure and facilities to reduce diseases and help in creating a healthy and fit population.
- (u) Cottage Industry.
- (v) Orphanage and Old Age Homes.

CONCLUSION

11. NGO are the true example of selfless service and teamwork. Employees are highly committed to the aims and the principles of the organisation. They share equal contribution with government organisation and social welfare programme. Though government on its part has introduced a number of programmes, however government cannot be entirely successful without the active participation by each member of society. NGOs provide the necessary platform towards this end.

LESSON PLAN : SA 4
CONTRIBUTION OF YOUTH TOWARDS SOCIAL WELFARE

Period	-	One
Type	-	Lecture
Code	-	SA 4
Term	-	I (SD/SW)

Training Aids

1. Computer, Projector, Charts, Pointer, Black Board & Chalk.

Time Plan

- | | | | | |
|----|-----|-----------------------|---|--------|
| 2. | (a) | Introduction | - | 05 Min |
| | (b) | Contribution of Youth | - | 30 Min |
| | (c) | Conclusion | - | 05 Min |

INTRODUCTION

3. Youth constitute the most creative segment of any society. Their role and contribution are vital to all societies and more so in a country like India with wide social, cultural and other demographic diversities. Youth constitute about 34 % of the total population of India and their role and contribution towards social welfare and nation building cannot be ignored. For a better understanding of the subject it is important to first understand the basic of social welfare.

4. Social welfare has been defined by a United Nations expert group as “ Organised activity that aims towards a mutual adjustment of individuals and their social environment”. Social welfare is considered as including the attempts made by governments and voluntary organizations to help families and individuals by maintaining incomes at an acceptable level.

AIM

5. To acquaint the cadets about the Contribution of Youth towards Social Welfare.

CONTRIBUTION OF YOUTH TOWARDS SOCIAL WELFARE

6. The contribution of youth towards social welfare have been discussed in the succeeding paras:-

(a) **Leadership.** Youth are the leaders of tomorrow and young and vibrant youth are essential for future leadership. Support is provided to voluntary organizations to participate in youth development programmes. Youth need to involve themselves in activities which will develop creditable leadership.

(b) **Community Service.** Youth need to work in social welfare activities and community services. Therefore, Community Service has been developed as an integral part of the curriculum for education, instruction and training of all students enrolled in educational institution so that youth can fruitfully understand and contribute in community service.

(c) **National and Cultural Integration.** The youth, when organized as youth force will contribute for the promotion of national and cultural integration of the country. Fostering and developing interaction between youth from different parts of the country specially the isolated border and tribal areas will help in achieving national integration. It should be the endeavour of youth to motivate the general public to work against the separatist forces and ensure unity of the country is maintained.

(d) **Education and Literacy.** The Youth need to educate themselves and subsequently get into the process of providing quality education to all sections of society. They need to promote education and self development capabilities of the rural youth specially of girls and youth in backward areas.

(e) **Environment.** The youth must understand the importance and implications of environment on the society and the ecological wealth of the nation. They must help in improving and protecting the environment. They need to engage in afforestation programmes and cleaning of rivers and lakes and disposal of degradable and non-degradable waste.

(f) **Health Care and Family Welfare.** They must promote awareness and involvement in social programmes pertaining to health and family welfare. Programmes such as 'Youth against AIDS' campaign, 'Pulse Polio', 'Small Family' norm and various immunization programmes should be promoted. They must also volunteer in manpower intensive programmes at the implementation stage.

(g) **Physical Education and Adventure Training.** The youth must understand the importance of physical education for health and physical fitness with a view to increasing individual productivity and the value of sports as a means of recreation and with a potential for promoting social harmony and discipline.

(h) **Old Age Care.** Our basic social fabric and the joint family system inherently provide for old age care. However with the breakdown of the joint family system the need for old age care has increased. The youth must contribute to the wellbeing of the senior citizen of the society by taking care of their aged and provide them financial security and moral self-respect and make all efforts to ensure that they have a secure old age with adequate housing and health care.

(j) **Watershed and Waste Land Development.** These two are one of our major resources which need to be continuously protected and systematically proclaimed and developed and can be used for various social welfare activities. Youth has genuine potential for this nature of work. They must contribute in these programmes and ensure that these areas are protected from unscrupulous elements who may enter these areas of interests, for personal gains.

CONCLUSION

7. Our youth are the strength of the family, village, locality and the community. They are also the future of our nation. We must take all necessary steps to mobilize this most idealistic, inspired and energetic section of our society in the mission of nation building and social welfare.

LESSON PLAN : SA 5
FAMILY PLANNING

Period	-	One
Type	-	Lecture
Code	-	SA 5
Term	-	III (SD/SW)

Training Aids

1. Computer, Projector, Chart, Pointer, Black Board & Chalk.

Time Plan

2.	(a)	Introduction	-	05 Min
	(b)	Family Planning	-	15 Min
	(c)	Measures to achieve Objectives	-	15 Min
	(d)	Conclusion	-	05 Min

INTRODUCTION

3. The rapid growth of population is one of the major problems facing the country today. Considering that the population of the country is over 1000 million and the annual surplus of births over deaths at 15 million, the population explosion continues. Some social facts like reluctance of uneducated masses and minority groups towards adopting family planning programmes emerge as major constraints. Family planning is not only concerned with limiting the measure of children through preventive measures, but very much related with aspects of health care and better standard of living.

4. Family planning is defined as the voluntary, responsible decision made by individual and couples as to the desired family size and timing of birth. Therefore on the micro level it means children are born because they are wanted and provided for and on the macro level it contributes to the betterment of human life.

AIM

5. To acquaint the cadets about the need for Family Planning.

PREVIEW

6. The lecture will be conducted in following parts:-
 - (a) Part I - Family Planning.
 - (b) Part II - Measures to achieve Objectives.

PART I : FAMILY PLANNING

7. **Factor Affecting Family Planning.** The following factors affect family planning:-
- (a) Fatal infant and childhood morbidity.
 - (b) Poor physical and intellectual development of the unwanted child.
 - (c) Pregnancy wastage.
 - (d) Maternal risk of illness and death.
 - (e) Father's risk of hypertension and gastric ulcers.
 - (f) Marital risk.
 - (g) Poor nutrition.
 - (h) Environmental hazards such as overcrowding, poor water supply and atmospheric contamination.
 - (j) Increased incidents of genetic diseases.
 - (k) Mental health problems of parents as well as children due to strains caused by large family.
8. **Methods of Family Planning.** Family planning can be achieved by following methods:-
- (a) Vasectomy.
 - (b) Tubectomy.
 - (c) Conventional contraceptives like condoms and diaphragms.
 - (d) Oral pills.

PART II : MEASURES TO ATTAIN OBJECTIVES

9. Effective measures to be under-taken are:-
- (a) Voluntary encouragement of family planning can have positive health benefits. In small families mother takes more care of child which is necessary for healthy development.
 - (b) Stringent laws be enacted to curb the menace and the violators severely punished. Couples violating family norms should be debarred from contesting elections and their voting rights withdrawn. A massive campaign could be launched through the electronic and print media to create conducive environment.
 - (c) Take steps encouraging a two-child norm so that growing population is controlled.
 - (d) Educating women particularly in backward and rural areas be taken up with complete sincerity, which would help in eradicating this menace.

- (e) Early marriage be strictly checked and efforts be made to raise the living standard and improve literacy rate.
- (f) Couples adopting family planning should be given all possible assistance. In this regard, couples should be made to attend counseling sessions after marriage in which they should be made aware of the needs and benefits of family planning.
- (g) The problem can also be solved by providing basic health care facilities specially to the backward classes and such families to be given assurances that proper health care would make sure their children survive.
- (h) Involvement of religious leaders in the programme.
- (j) Development of rural areas.

CONCLUSION

10. Family planning assumes greater importance today as population has passed the one billion mark. Rapid growth of population is straining the available resources. In India resources are already scarce. There will be scarcity of land, houses and food coupled with unemployment. This will give rise to crime in the society. There is an immediate requirement to educate the masses involving religious, political and intellectual aspects to motivate them to adopt family planning if we want to see India as the economically and technologically leading nation in the world.

LESSON PLAN : SA 6
DRUG ABUSE AND DRUG TRAFFICKING

Period	-	One
Type	-	Lecture
Code	-	SA 6
Term	-	II (SD/SW)

Training Aids

1. Computer, Projector, Charts, Pointer, Black Board & Chalk.

Time Plan

2. (a) Introduction - 05 Min
- (b) Types of Drugs - 15 Min
- (c) Drug Abuse and Trafficking - 15 Min
- (d) Conclusion - 05 Min

INTRODUCTION

3. A `DRUG` is a substance—solid, liquid or gas that brings about physical and / or psychological changes. Drugs affect the central nervous system. They act on the brain and can change the way a person thinks, feels or behaves. These drugs are known as psychoactive drugs. Drug menace is one of the most serious problems facing the world. Drug trafficking and drug abuse are considered as a greater problem than drug consumption.

AIM

4. To acquaint the cadets about the Drug Abuse and Drug Trafficking.

PREVIEW

5. The lecture will be conducted in following parts:-
 - (a) Part I - Types of Drugs.
 - (b) Part II - Drug Abuse and Trafficking.

PART I : TYPES OF DRUGS

6. **Types of Drugs.** There are three main types of drugs affecting the central nervous system:-

(a) **Depressants.** Depressants are drugs that slow down the function of the central nervous system. Depressant drugs do not necessarily make a person feel depressed. They include:-

- (i) Alcohol.

- (ii) Cannabis.
- (iii) Barbiturates, including Seconal, Tuinal and Amytal.
- (iv) Benzodiazepines (Tranquilisers), Benzos, Tranx, such as Rohypnol, Valium, Serepax, Mogadon, Normison and Eupynos.
- (v) GHB (Gamma- hydroxybutrate), or Fantasy.
- (vi) Opiates and Opioids, including Heroin.

(b) **Stimulants.** Stimulants act on the central nervous system to speed up the messages to and from the brain. They make the user feel more awake, alert or confident. Stimulants increase heart rate, body temperature and blood pressure. Other effects include appetite, dilated pupils, talkativeness, agitation and sleep disturbance. Mild stimulants include:-

- (i) Ephedrine used in medicines for bronchitis, high fever and asthma.
- (ii) Caffeine in coffee, tea and cola drinks.
- (iii) Nicotine in tobacco.

(c) **Hallucinogens.** Hallucinogens affect perception, People who have taken them may believe they see, hear and perceive things that are not really there or what they see may be distorted in some way. The effects of hallucinogens vary a great deal, so it is impossible to predict how they will affect a particular person at a particular time. Hallucinogens include:-

- (i) Dhatura.
- (ii) Ketamine.

7. **Legal Drugs.** These are those where laws and regulations control the availability, quality and price of the legal drugs. For example tobacco may not be sold to persons below age of 18 years.

8. **Illegal Drugs.** Because they are illegal there are no prices or quality controls on the illicit drugs such as heroin. This means that a user can never be sure that the drug they are taking is in fact what they think it is. The user also cannot be sure of a drug's strength or purity. Various batches of an illegally manufactured drug may have different mixtures of the drug and additives such as poisons, caffeine or even talcum powder.

PART II : DRUG ABUSE AND TRAFFICKING.

Drug Abuse

9. **What is Drug Abuse.** It is a patterned use of a substance (drug) in which, the user consumes the substance in amounts or with methods, neither approved nor supervised by medical professionals. Drug abuse is not limited to mood-altering or psycho-active drugs. If an activity is performed using the objects against the rules and policies of the matter (as in the case of steroids for performance enhancement in sports), it is also called drug abuse. Using illicit drugs – narcotics, stimulants, depressants (sedatives), hallucinogens, cannabis, even glues and paints, are also considered to be classified as drug abuse. Continuous and prolonged abuse of drugs may make a person an addict.

10. It was found that all the addicts either take cannabis or heroin. 72% percent of addicts are in the age group of 20-24 years, And females comprise only 2% of the addicts. 78% of addicts come from the families which are facing problems such as, loss of one or both parents or separation of the parents.

11. Drug addiction is found to be most common in peer group. The other reasons are curiosity (19.85%), pleasure seeking (12%) and mental tension (5%). Majority of addicts (84%) mention that the drug is easily available to them. Education and occupation has no significant effect on the habit. The problem of drug addiction appears to be common amongst youths (20-24 yrs). High incidents in youth may be due to their emotional immaturity.

Drug Trafficking

12. India, due to its geographical location has become a transit route base for illicit heroin, hashish and morphine from Afghanistan, Pakistan, Iran, Nepal and Burma. This area is known as Golden Crescent. Cannabis smuggled from Nepal is mainly consumed in India. Most heroin transiting through India is bound for Europe.

13. A peculiar system of supply and demand that characterizes the Indian drug market is that the user and traders are often the same. To fund drug consumption many users resort to crimes and thefts. The drug syndicates often use poor people, especially youth to carry their illicit products from one place to another, at a hefty price, which makes the youth fall for this easy money. The youth do not understand the dangers of this illegal activity.

14. **The Law.** Control over cultivation of opium and all matters relating to narcotic drugs and psychotropic substances are regulated by the "Narcotic Drugs and Psychotropic Substances (NDPS) Act and Rules", which provide for:-

- (a) Punishment of upto 20 yrs Rigorous Imprisonment and fine up to Rupees Two Lakhs for indulging in trafficking of narcotic drugs and psychotropic substances.
- (b) Death sentence in case of repeat of this offence.
- (c) Forfeiture of property of smugglers.
- (d) Regulating of legitimate trade and commerce of NDPS for medicinal and scientific purposes. The "Prevention of Illicit Trafficking in Narcotic Drugs and Psychotropic Substances" (PITNDPS) provides for detention of persons indulging in trafficking of narcotic drugs for 1 to 2 years by an executive order.

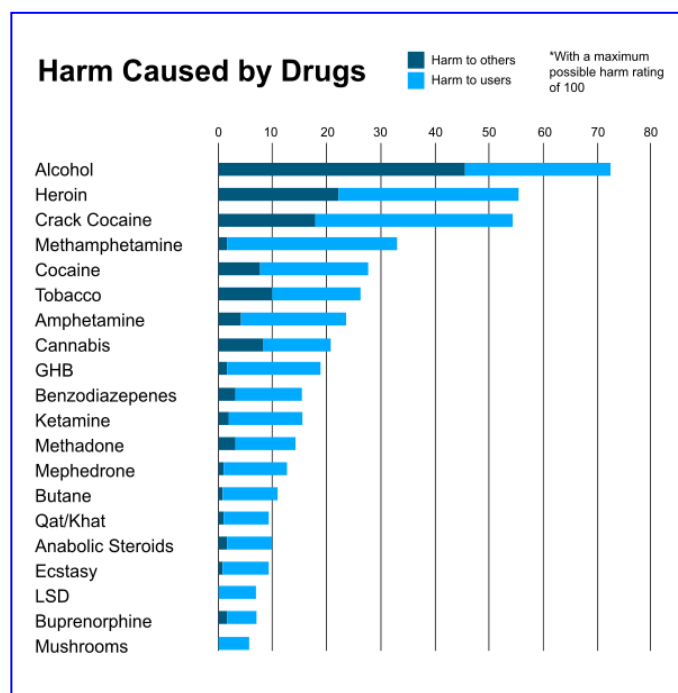

CONCLUSION

15. Drug trafficking and consumption has become a global menace. To eradicate this, it requires mobilisation of international communities through a comprehensive approach in combating illicit production, trafficking and consumption of drugs. Government and NGOs should emphasise on education, healthcare, treatment and rehabilitation for effective control of drug abuse.

LESSON PLAN : SA 7
CIVIC RESPONSIBILITIES

Period	-	One
Type	-	Lec
Code	-	SA 7
Term	-	I (SD/SW)

Training Aids

1. Computer, Projector, Pointer, Charts, Black Board & Chalk.

Time Plan

- | | | | | |
|----|-----|------------------------|---|--------|
| 2. | (a) | Introduction | - | 05 Min |
| | (b) | Civic Responsibilities | - | 30 Min |
| | (c) | Conclusion | - | 05 Min |

INTRODUCTION

3. Sense of community (or psychological sense of community) is a concept in community psychology and social psychology, as well as in several other research disciplines, such as urban sociology, which focuses on the experience of community rather than its structure, formation, setting, or other features. Sociologists, social psychologists, anthropologists, and others have theorized about and carried out empirical research on community, but the psychological approach asks questions about the individual's perception, understanding, attitudes, feelings, etc. about community and his or her relationship to it and to others' participation-indeed to the complete, multifaceted community experience.

AIM

4. To acquaint the cadets about Civic Responsibilities.

UNDERSTANDING CIVIC RESPONSIBILITIES

5. Civic Sense is the sense in an individual which makes him a civilized citizen of a country. However, it is certainly more than just that. Civic Sense means social ethics, the positive perception, understanding, attitudes, towards society or community. Its the behavior between individuals and groups, civility and unspoken principles of society. Civic Sense is not just about keeping the roads clean and avoiding the violation of basic civic rights, its about respecting one another, abiding by the law and maintaining proper etiquette in public places.

6. Nowadays, we are so busy that we do not have time to spare. We absolutely lack basic civic sense and some of us are not even bothered. Why is it that only a few of us need to do our homework and raise an alarm? We see people littering, smoking in public places, cutting off plants and many other violations everyday. There are so many products that we use mindlessly every day, without a thought of how they might be affecting the environment around us. The time has come for us to think carefully before we use a product and look for healthy alternatives. Aren't we all proud to live in a city that boasts a high standard of living and good infrastructure? Why is it that when it comes to civic sense, we turn a blind eye?

7. In some people civic sense is found to be inadequate. The reason for this is plausible for, never are some people formally taught to treat things that belong to others nicely, kindly and well. Nowhere in any syllabus in a school or in a daily routing at home is civility part of the program to be instilled, it is instead conspicuous by its absence. Some of the children are not taught to treat the neighbourhood, the society and public property as something meant to be maintained well. What is being taught to some of the children is just to keep themselves, their things and their homes in order. The society is becoming not my concern. With this attitude, it is no wonder that parks, cinemas, roads are all littered, because they do not belong to anyone. Some of the people feel that the municipality is to look after these but, what about the public contribution? Some of the people only contribute filth wherever they can.

8. Some of the people clean our homes and throw the rubbish in front of our neighbour's home, we eat sweets and chocolates and throw wrappers here there and everywhere. A very common sight is a biscuit wrapper being flung out of a speeding car in the middle of the road. This only goes to show how very civic minded our so called creamy layer of society is. If this is the standard of the cream, the less said about others, the better it would be. One just has to go to a newly built cinema house with all the most modern gadgets but, all the walls are full of pan spit. Is this how we care for our public property? Would we destroy the walls of our homes? No definitely not, then why this indifference for public property? This is because we have become and continue becoming more and more selfish and self-centered. We only look at self and nothing else around us matters. Yet, at the same time if we do not have public amenities - we shout the loudest. What an irony? We want everything but cannot contribute to the maintenance of anything. This is the standard of our civic sense. In this, the most tragic fact about the whole affair is that we are at no stage of life taught to respect other peoples' property or public property. It is the educated and the rich who should be the best conducted, contribute maximum to lack of civic sense. We must make destroying of public property a punishable offence then people might be less frivolous to civilities.

CONCLUSION

9. Civic Sense is that sense in an individual which makes him a civilized citizen of a country. As far as the normal understanding is concerned, it is felt that people from cultured, educated and belonging to the upper strata are more or less quite civilized and have a huge stock of civic sense. Lack of civic sense is not far to seek, we find it all pervading no matter where we go. At home, in our neighbourhood, in the colony, on the road, in the office, in a theatre, in a restaurant and everywhere we go, we are duty bound to have civic sense.

LESSON PLAN : SA 8
CAUSES / PREVENTION OF HIV / AIDS
AND ROLE OF YOUTH

Period	-	One
Type	-	Lecture
Code	-	SA 8
Term	-	I (SD/SW)

Training Aids

1. Computer, Projector, Charts, Pointer, Black Board & Chalk.

Time Plan

2.	(a)	Introduction	-	03 Min
	(b)	Causes of HIV / AIDS	-	10 Min
	(c)	Prevention of HIV / AIDS	-	15 Min
	(d)	Role of Youth	-	10 Min
	(e)	Conclusion	-	02 Min

INTRODUCTION

3. Few diseases have been feared as much as HIV/AIDS has been ever since human beings began efforts to prevent and control major diseases. Although a large number of health problems continue to defy human efforts to control them, none of them presents a challenge greater than the prevention and control of HIV/AIDS.

4. Globally, an estimated 38.6 million people are living with HIV, of which an estimated 4.1 million were new infections. In Asia, an estimated 8.2 million people are living with HIV including 1.2 million new infections last year. In India, an estimated 5.2 million people are living with the virus, most of whom are poor and marginalized. The patterns of HIV infection in India reflect underlying patterns of social and economic inequality, such as distribution of wealth, power, gender relations, women's status, poverty, lack of sustainable livelihoods, civil unrest and disorder, etc.

AIM

5. To acquaint the cadets about the Causes and Prevention of HIV / AIDS and the Role of Youth.

PREVIEW

6. The lecture will be conducted in following parts:-
 - (a) Part I - Causes of HIV / AIDS.
 - (b) Part II - Prevention of HIV / AIDS.

PART I : CAUSES AND PREVENTION OF HIV / AIDS

7. **What is HIV / AIDS.**

(a) Although HIV and AIDS are often used synonymously, they are different. HIV (Human Immuno-deficiency Virus) is a virus that gradually destroys the body's immune system. AIDS (Acquired Immuno Deficiency Syndrome) is a condition wherein various diseases affect the body because of the body's weak natural defense mechanism – the immunity. AIDS stand for Acquired (not inborn, but passed from mother to baby), Immune (relating to the body's immune system, which provides protection from disease causing bacteria/viruses/ fungi); Deficiency (lack of response by the immune system to bacteria / viruses / fungi / cancer cells); Syndrome (a number of signs and symptoms indicating a particular disease or condition).

(b) Therefore, AIDS is an acquired condition in which a person may have various diseases that cause similar symptoms, all of which are due to the body's diminished ability to fight diseases. Anyone who has HIV infection will develop AIDS over a period of time.

8. **How Does HIV Affect the Body.** A special variety of white blood cells called T lymphocytes secrete chemicals that are necessary for destroying the disease causing germs or agents. HIV destroys T lymphocytes (also called T-cells), and thereby reduces the body's ability to fight diseases. T-cells contain a protein called CD4 on their surface. HIV first attaches itself to CD4 and then fuses with the T-cells to multiply. Fusion with T-cells destroys the T cell and several copies of HIV are produced.

9. **How Does HIV/AIDS Spread.** HIV is present in all body fluids of an infected person and is more in number, in the blood, semen and vaginal fluids. HIV infection normally spreads when there is contact with these body fluids through four main routes:-

(a) **Sexual Transmission.** The most common route of spread of HIV infection is through unprotected sex between two people, where at least one has HIV infection. Unprotected sex means having sex without condom. Although the risk of HIV being transmitted during one sexual act depends upon several factors, it is important to remember that even one episode of unprotected sex with an infected partner can transmit HIV. Increased number of unprotected sex increases the risk of infection. Some issues related to sexual transmission of HIV are as under:-

(i) **Increased Risk for Women.** Women are at greater risk of developing HIV infection through unprotected sex. This means that the risk of transmission of HIV from man to woman is higher than that from woman to man. There are five main reasons why women are at greater risk:-

(aa) The semen from the infected male sexual partner remains in the woman's vagina for a longer time, thereby increasing the duration of contact between infected semen and delicate lining of the vagina.

(ab) The surface area of the vagina is larger than the surface of tip of the penis in men, which provides greater opportunity for the virus to enter the body.

(ac) Many women with sexually transmitted infections (STIs) do not have any symptoms and therefore do not seek treatment. Presence of STIs increases the risk of HIV transmission.

(ad) The gender imbalance makes it difficult for women to exercise their sexual rights. This means that they have less control over, when and with whom, they have sex.

(ae) Women are less likely to take treatment, especially for STIs, which increase the risk of HIV transmission.

(ii) **Sexually Transmitted Infections.** Presence of STIs increases the risk of HIV transmission. People who have ulcers in the genital organs or abnormal discharge either from the penis or the vagina are at higher risk of HIV transmission. Early treatment of STIs reduces the risk of HIV infection.

(iii) **Anal Sex.** Although anal sex is more common among men, who have sex with men (MSM), some heterosexual partners also practice it. Anal sex has higher risk of HIV transmission as compared to vagina sex. This is mainly because the delicate inner lining of the anus gets easily damaged during anal sex. This damage helps the HIV to enter the body easily.

(iv) **Menstruation.** The menstrual blood of a woman with HIV infection will contain the virus. Thus, sexual intercourse during menstruation with an infected woman increases the risk of the male partner getting HIV infection.

(b) **Blood Transfusions.** As per the guidelines of the National AIDS Control Organization (NACO), it is mandatory to test blood for HIV before transfusion. The risk of transmission of HIV through tested blood is therefore very remote. The only possibilities of infection through blood are, if the blood was not tested for HIV or the HIV infection was in the *window period*. Window period is the term used for the duration between the entry of HIV in the body and the detection of its antibodies through blood tests. Window period is normally up to three months. This means that during this time, even if a person is HIV infected he/she will test negative. He/she can however transmit infection to others. **Blood donation has no risk of getting HIV infection because the needle and other equipment used for collecting your blood are safe.**

(c) **Sharing Needles and Syringes for Intravenous Drug Use.**

(i) When people inject drugs intravenously, they may draw small amounts of blood into the needle. If another person uses this needle immediately, the blood containing HIV will be injected into the second person. Thus, he/she can also be infected with HIV.

(ii) Despite several concerns about the poor sterilisation practices by some doctors, especially in rural areas, HIV infection through injections given at a health centre is not a common mode of transmission in India. This is mainly because most of these doctors, even if they are not qualified, boil them for a short time. HIV is destroyed by even short duration heat and drying. Shorter boiling time for sterilizing needles may not destroy other disease causing germs such as Hepatitis B virus. It is also important to remember that injections that are given in the muscles, under the skin or in the skin layers carry little risk of transmitting the HIV.

(iii) For several years now, rumours are periodically spread about people with HIV infection, intentionally pricking other people with infected needles in public places such as movie theatres, markets, bus-stops etc. with an intention of transmitting the infection to them. These rumours are baseless because of three main reasons:-

(aa) There should be adequate amounts of blood containing the virus on the needle before it can cause infection. A needle that has been merely

pricked in the body of a person with HIV is not likely to have the number of HIV necessary to cause infection.

(ab) Even if the infected person were to use needle that has been used intravenously, the virus may not be alive if the blood on the needle has dried up.

(ac) When an infected needle is pricked into the muscles, the risk of transmitting the infection is very low.

(d) **Mother to Child Transmission.** Mother to child transmission of HIV can occur in three ways:-

(i) During pregnancy, when the HIV crosses the placenta.

(ii) During delivery.

(iii) **During Breastfeeding.** Although HIV is present in breast milk, it does not mean that the baby will always be infected with it. Also, in a country such as India, the alternative to breast-feeding is bottle-feeding, which is not only expensive but also carries a higher risk of diarrhoea, poor nutrition and as a result death. Since the benefits of breast-feeding are much more than the risk of getting HIV infection, it is recommend that women with HIV infection breast-feed their babies.

(e) **Other Methods.**

(i) **Skin Piercing.** There are several cultural practices in India that involve skin piercing such as, piercing ears or nose for ornamental reasons, tattooing, etc. Although skin piercing is not currently one of the major routes of transmission of HIV infection in India, it is desirable to use sterilized equipment for prevention of infections such as Hepatitis B.

(ii) **Oral Route.** Many people believe that kissing, sharing utensils etc. with people who have HIV can transmit the infection. This is not true. HIV has not been shown to be transmitted through saliva. If the virus is ingested in the stomach, the acids in it are likely to inactivate or destroy the virus. The risk through oral route may be there only if there are cuts or wounds in the mouth or bleeding gums.

10. **How is HIV Diagnosed.** HIV is normally diagnosed through blood tests that detect antibodies to HIV. It is recommended that the tests are done only at the Voluntary Counselling and Testing Centres (VCTCs) set up by National AIDS Control Organisation (NACO). Counselling is done before and after the test in order to ensure that the person being tested is aware of all the issues related to HIV transmission, prevention, treatment, care and support. In case of a negative test result, the test is repeated after three months to rule out the possibility of the first test being carried out in the window period. Confidentiality is strictly maintained while testing for HIV. This means that no one other than the person being tested is informed about the test results.

PART II : PREVENTION OF HIV/AIDS

11. **Symptoms of HIV.**

(a) Most people infected with HIV are not likely to have any symptoms for about three to ten years. Few develop symptoms earlier while few others may not develop any symptoms for more than ten years. Even if a person does not have symptoms, he/she can transmit the infection to others. This is why it is recommended that anyone who has sex with a partner who is not in mutually faithful relationship should use condoms for every sex.

(b) A normal person has about 500 to 1500 CD4 cells per millilitre of blood. When the CD4 count decreases below 200, people with HIV can present with opportunistic infections, which are infections, that affect the body because of poor immunity. Opportunistic infections are caused by bacteria, virus, fungus and parasites. They may also get some types of cancer.

(c) When HIV progresses to AIDS, the infected person would have had unexplained weight loss of more than ten percent, unexplained diarrhoea or fever for more than one month, fungal infections, tuberculosis or severe bacterial infections.

12. **Tuberculosis**. Since tuberculosis is already one of the major health problems in India, people with HIV infection are at higher risk of getting it. Very often, tuberculosis is the first indication that a person has HIV infection. Although tuberculosis largely affects the lungs, it can affect other organs of the body also. People with AIDS are more likely to get infection in other organs of the body. One of the major concerns related with tuberculosis and AIDS is resistance of the tuberculosis bacteria to several medicines that were earlier effective for its treatment. Common symptoms of tuberculosis include cough, fever, increased sweating at nights, loss of weight and excessive fatigue.

13. **HIV Prevention**.

(a) HIV/AIDS can be prevented in four main ways:-

(i) Being in a mutually faithful sexual relationship. If this is not possible, then correct and consistent use of condoms for every sexual act, irrespective of the type of sex is essential.

(ii) Checking all the blood and blood products for HIV infection before transfusion.

(iii) Avoiding drug abuse, especially sharing needles and syringes for injecting drugs.

(iv) Reducing the risk of mother-to-child transmission by following recommended guidelines for preventing parent to child transmission of HIV infection.

(b) **Condom Use**. Condoms have two main advantages-they prevent infections such as sexually transmitted infections (STIs) and HIV, and also prevent pregnancy. Many people use condoms only for commercial sex. It is important to remember that anyone who is not in a mutually faithful sexual relationship should use condoms for every sex. There are some myths about the use of condoms which are not true. These are:-

(i) Some people argue that condoms do not offer complete protection. This is not true. It is only the inconsistent and incorrect use of condoms, which may lead to contracting STD or HIV.

(ii) Some people complain that condoms, especially those that are distributed free by the government, are probably not of good quality and therefore break during sexual act. These complaints are not valid, as several strict quality control methods are adopted during condom manufacturing.

(iii) A belief that condoms reduce sexual pleasure, is one of the major barriers to condom use. This is also not true. There may be a difference in the sensation in the initial stages of using condoms but most people adapt to them very soon.

(c) **Preventing Parent to Child Transmission.** NACO has set up 'Prevention of Parent to Child Transmission (PPTCT) centres in all districts of the six states where HIV infection is high and in several other hospitals in other states. In these centres, pregnant women are counselled and tested for HIV. If they are positive, they are given medicines for HIV at the time of delivery and caesarean section is done to surgically deliver the baby. This reduces the risk of infection for the newborn from about 45% to less than 2%.

14. **Ethical Issues Related to HIV Infection.** Ethical issues related to HIV infection are mainly for ensuring that a person with HIV infection leads a life of dignity. HIV testing should not be done without informed consent of the person to be tested. This means that the person to be tested should have understood what test results would mean and its likely impact on his/her life. People with HIV infection have as much right to get education, employment and medical treatment from any source as everyone else.

PART III : ROLE OF THE YOUTH IN PREVENTING HIV / AIDS

15. HIV is more common in the most productive age group of 15-45 years, and therefore causes major impacts on the economic status of the affected individual, family, community, and the nation at large. The young adults can play a very important role in preventing the HIV at community level, and also minimise its impact at all levels by taking following actions :-

(a) Youth can assume responsibility in preventing HIV infections by avoiding behaviour that might lead to HIV infections.

(b) Youth may also share the right to refuse sex and assume responsibility for ensuring safe sex.

(c) People living with HIV/AIDS have the same right to education, employment, health, travel, marriage, recreation, privacy, social security, scientific benefits etc. Hence, all should share responsibilities for avoiding HIV infection / re-infection.

(d) The youth by creating a proper and positive peer pressure, can delay the age at first sex, avoid sex before marriage, practicing safer sex, and preventing alcohol and drug abuse. The stereotypical image of a "macho" male needs to be changed to depict responsible behaviours.

(e) The young can also play an important role in addressing gender imbalance, which is one of the important factors for underdevelopment and HIV transmission.

(f) Youth should also educate general public by spreading the information that HIV can not be transmitted by the following actions:-

(i) Shaking Hands.

(ii) Sharing of Clothes.

(iii) Sharing of Food and Utensils.

(iv) Sharing of Toilets.

(v) Insect Bites.

(vi) Hugging or Kissing.

(vii) Working in the same office or travelling in the same vehicle.

(viii) Playing or swimming with the infected person.

- (ix) Coughing, sneezing or in routine patient-care activities (bed - making, feeding etc).

CONCLUSION

16. HIV can be transmitted from person to person only if the body fluids like blood, semen and vaginal fluids come in contact with body fluids of an HIV infected or AIDS patient. Young people, with or without HIV/AIDS, have an important role to play in actively countering discrimination against young people living with HIV/ AIDS. We require to provide a platform for people living with HIV/AIDS, so that we work together according to their interests. We also need to mobilize support of local authorities and community leaders to listen to people living with HIV/AIDS and to combat actively against their discrimination and exclusion. Setting up training programmes, to improve the integration of the young people suffering from HIV/AIDS into society, is the need of the hour.

LESSON PLAN : SA 9
TERRORISM AND COUNTER TERRORISM

Period	-	Two
Type	-	Lecture
Code	-	SA 9
Term	-	III (SD/SW)

Training Aids

2. Computer, Projector, Charts, Pointer, Black Board & Chalk.

Time Plan

2.	(a)	Introduction	-	05 Min
	(b)	Terrorism	-	35 Min
	(c)	Counter Terrorism	-	35 Min
	(d)	Conclusion	-	05 Min

INTRODUCTION

3. Counter-terrorism incorporates the practices, tactics, techniques, and strategies that governments, militaries, police departments and corporations adopt to attack terrorist threats and/or acts, both real and imputed. The tactic of terrorism is available to insurgents and governments. Not all insurgents use terror as a tactic, and some choose not to use it because other tactics work better for them in a particular context. If the terrorism is part of a broader insurgency, counter-terrorism may also form a part of a counter-insurgency doctrine, but political, economic, and other measures may focus more on the insurgency than the specific acts of terror. Counter-terrorism includes both the detection of potential acts and the response to related events.

AIM

4. To acquaint the cadets about Counter Terrorism.

PREVIEW

5. The lecture will be conducted in following parts:-
- | | | | |
|-----|---------|---|---|
| (a) | Part I | - | Terrorism and Terrorist Methods / Strategy. |
| (b) | Part II | - | Methods to Counter Terrorism. |

PART I : TERRORISM AND TERRORIST METHODS / STRATEGY

6. **General.** Terrorism has often been an effective tactic for the weaker side in a conflict. As an asymmetric form of conflict, it confers coercive power with many of the advantages of military force at a fraction of the cost. Due to the secretive nature and small size of terrorist organizations, they often offer opponents no clear organization to defend against or to deter. The strategy of terrorists is to commit acts of violence that draws the attention of the local populace, the

government, and the world to their cause. The terrorists plan their attack to obtain the greatest publicity, choosing targets that symbolize what they oppose. The effectiveness of the terrorist act lies not in the act itself, but in the public's or government's reaction to the act.

7. **Definition.** The United Nations definition of terrorism is *"An anxiety-inspiring method of repeated violent action, employed by (semi-) clandestine individual, group or state actors, for idiosyncratic, criminal or political reasons, whereby - in contrast to assassination - the direct targets of violence are not the main targets."*

8. **Aim of Terrorists.** A terrorist group commits acts of violence to :-

- (a) Produce widespread fear.
- (b) Obtain worldwide, national, or local recognition for their cause by attracting the attention of the media.
- (c) Harass, weaken, or embarrass government security forces so that the the government overreacts and appears repressive.
- (d) Steal or extort money and equipment, especially weapons and ammunition vital to the operation of their group.
- (e) Destroy facilities or disrupt lines of communication in order to create doubt that the government can provide for and protect its citizens.
- (f) Discourage foreign investments, tourism, or assistance programs that can affect the target country's economy and support of the government in power.
- (g) Influence government decisions, legislation, or other critical decisions.
- (h) Free prisoners.
- (i) Satisfy vengeance.
- (j) Turn the tide in a guerrilla war by forcing government security forces to concentrate their efforts in urban areas. This allows the terrorist group to establish itself among the local populace in rural areas.

9. **Type of Terrorist Acts.** The most common types of terrorist incidents include:-

- (a) **Bombings.** Bombings are the most common type of terrorist act. Typically, improvised explosive devices are inexpensive and easy to make. Modern devices are smaller and are harder to detect. They contain very destructive capabilities causing huge damage especially in crowded places. Terrorists can also use materials that are readily available to the average consumer to construct a bomb.
- (b) **Kidnappings and Hostage-Takings.** Terrorists use kidnapping and hostage-taking to establish a bargaining position and to elicit publicity. If a kidnapping is successful, it can gain terrorists money, release of jailed comrades, and publicity for an extended period. Hostage-taking involves the seizure of a facility or location and the taking of hostages. Hostage-taking provokes a confrontation with authorities. It forces authorities to either make dramatic decisions or to comply with the terrorist's demands.
- (c) **Armed Attacks and Assassinations.** Armed attacks include raids and ambushes. Assassinations are the killing of a selected victim, usually by bombings or small arms. Drive-by shootings is a common technique employed by unsophisticated or loosely

organized terrorist groups. Historically, terrorists have assassinated specific individuals for psychological effect.

(d) **Arsons and Fire Bombings.** Incendiary devices are cheap and easy to hide. Arson and fire bombings are easily conducted by terrorist groups that may not be as well-organized, equipped, or trained as a major terrorist organization. An arson or firebombing against a utility, hotel, government building, or industrial center portrays an image that the ruling government is incapable of maintaining order.

(e) **Hijackings and Skyjackings.** Hijacking is the seizure by force of a surface vehicle, its passengers, and/or its cargo. Skyjacking is the taking of an aircraft, which creates a mobile, hostage barricade situation. It provides terrorists with hostages from many nations and draws heavy media attention. Skyjacking also provides mobility for the terrorists to relocate the aircraft to a country that supports their cause and provides them with a human shield, making retaliation difficult.

(f) **Other Types of Terrorist Incidents.**

(i) **Maiming's.** Terrorist groups conduct maiming's against their own people as a form of punishment for security violations, defections, or informing.

(ii) **Robberies and Extortion.** Terrorist organizations also conduct robberies and extortion when they need to finance their acts and they don't have sponsorship from sympathetic nations.

(iii) **Cyber Terrorism.** This is a new form of terrorism that is only going to increase in profile as we rely on computer networks to relay information and provide connectivity to today's modern and fast-paced world. Cyber terrorism allows terrorists to conduct their operations with little or no risk to themselves. It also provides terrorists an opportunity to disrupt or destroy networks and computers. The result is interruption of key government or business-related activities. This type of terrorism isn't as high profile as other types of terrorist attacks, but its impact can be very destructive.

PART II : COUNTER TERRORISM

10. **General.** Most counter-terrorism strategies involve an increase in standard police and domestic intelligence. The central activities are traditional: interception of communications, and the tracing of persons. New technology has, however, expanded the range of military and law enforcement operations. Domestic intelligence is often directed at specific groups, defined on the basis of origin or religion, which is a source of political controversy.

11. **Counter Terrorism Strategy.** This includes following actions:-

(a) **Preparation.** This includes following action:-

(i) Identification of areas of likely terrorist target and keeping such areas under continuous surveillance / guard and hardening them by creating multi-tiered layer of security checks / protection / obstacles.

(ii) Earmarking rapid response teams (QRTs) from local police for immediate reaction / cordoning of the area.

(iii) Earmarking specialist units (like NSG) for tackling of terrorist threats.

(iv) Preparation of plans for requisition of Army / other agencies like fire deptt, health deptt and bomb disposal units for assistance.

(b) **Pre-emptive Action.** This involves a 24x7 action plan to track and monitor all activities of terrorist / terrorist groups. This includes the following:-

- (i) Collection and Collation of all type of Intelligence of suspected / known terrorist groups / persons especially foreign travel, financial transactions, face book / internet accounts and telephone conversations.
- (ii) Physical Tracking / Surveillance of the suspected persons / groups.
- (iii) Pre-emptive neutralization by apprehension / detention of suspected persons/ terrorists.

12. **NCTC.** In order to counter terrorism, the Central Govt has formulated a new policy and established an central agency to deal with the threat. This is called the **National Counter Terrorism Center (NCTC)**. The NCTC will derive its powers from the Unlawful Activities Prevention Act, 1967. It is to be a part of the Intelligence Bureau and will be headed by a Director who will report to the Director, IB and the Home Secretary. The NCTC will execute counter-terror operations and collect, collate and disseminate data on terrorism besides maintaining a data base on terrorists and their associates including their families. The NCTC has been empowered to analyse intelligence shared by agencies like the Intelligence Bureau and select what it deems suitable. It has also been granted powers to conduct searches and arrests in any part of India and will formulate responses to terror threats.

CONCLUSION

13. Countering terrorism is not the responsibility of the govt alone. As citizens and NCC cadets, it is our responsibility that, we act as 'eyes and ears' of the state machinery, for collection of any terrorist related info. Also, at the time of need we can be part of the assistance to be provided in a terrorist incident.

LESSON PLAN : SA 10
CORRUPTION

Period	-	One
Type	-	Lecture
Code	-	SA 10
Term	-	II (SD/SW)

Training Aids

1. Computer, Projector, Charts, Pointer, Black Board & Chalk.

Time Plan

2.	(a)	Introduction	-	03 Min
	(b)	Types of Corruption	-	20 Min
	(c)	Methods of Corruption and Preventive Measures	-	15 Min
	(d)	Conclusion	-	02 Min

INTRODUCTION

3. Anti-corruption watchdog Transparency International, currently ranks the national perception of corruption in India to be 87th highest in the world (in an index of 182 positions). However, the real significance of perceptions of corruption does not lie in the extent to which phenomena such as bribery are perceived to be prevalent across society. A more important assessment is of how differing forms of corruption are deemed to be concentrated at different levels of the state. In India, public scandals of the previous twenty years, which link numerous elected politicians and even government ministers to repeated acts of parliamentary corruption, embezzlement, land seizure, blackmail, extortion, kidnap and murder, serve to erode the assumption of legitimate political authority and the efficacy of the ballot box.

AIM

4. To acquaint the cadets about Corruption and its Prevention.

PREVIEW

5. The lecture will be conducted in following parts:-
 - (a) Part I - Types of Corruption.
 - (b) Part II - Methods of Corruption and Preventive Measures.

PART I : TYPES OF CORRUPTION

6. **Definition.** The word **corrupt** means to abuse or destroy. Corruption can therefore be defined as the abuse of entrusted power for private gains. It hurts everyone who depends on the integrity of people in a position of authority.

7. **Types of Corruption.**

(a) **Petty Corruption.** "Petty" corruption occurs at a smaller scale and occurs within established social frameworks and governing norms. Examples include the exchange of small improper gifts or use of personal connections to obtain favors. This form of corruption is particularly common in developing countries and where public servants are significantly underpaid.

(b) **Grand Corruption.** "Grand" corruption is defined as corruption occurring at the highest levels of government, in a way that requires significant subversion of the political, legal and economic systems. Such corruption is commonly found in countries with authoritarian or dictatorial governments and in those without adequate policing of corruption by anti-corruption agencies.

(c) **Systemic Corruption.** Systemic corruption is, corruption which is primarily due to the weaknesses of an organization or process. It can be contrasted with individual officials or agents who act corruptly within the system. Factors which encourage systemic corruption include conflicting incentives, discretionary powers; monopolistic powers; lack of transparency; low pay; and a culture of impunity.

8. **Different Sectors of Corruption.** Corruption can occur in many different economic sectors whether it be public or private, industry or even NGOs as under:-

(a) **Government / Public Sector.** Public / government sector corruption is one of the more dangerous forms of corruption, as corruption of the governing body can lead to widespread effects.

(b) **Legislative System (Political).** Political corruption is the abuse of public power, office, or resources by elected government officials for personal gain, e.g. by extortion, soliciting or offering bribes. It can also take the form of office holders maintaining themselves in office by purchasing votes by enacting laws which use taxpayers' money.

(c) **Executive System (Police).** Police corruption is a specific form of police misconduct, designed to obtain financial benefits, other personal gain, and / or career advancement for a police officer or officers, in exchange for not pursuing, or selectively pursuing, an investigation or arrest.

(d) **Judiciary System.** Judicial Corruption refers to corruption related misconduct of judges, through receiving or giving bribes, improper sentencing of convicted criminals, bias in the hearing and judgement of arguments and other such misconduct.

(e) **Corporate.** As corporations and business entities grow larger, sometimes with a monetary turnover many times that of small countries, the threat of corruption in the business world, within the organization, in dealings with other organisations and in dealings with the government is a looming and growing threat. Companies may also indulge in political corruption.

(f) **Unions.** Labour unions were formed to protect and further the rights of employees via collective bargaining. However, as with other entities, corruption has been known to happen within the organizations. In addition, some unions have been infiltrated by, or associated with organized crime syndicates.

(g) **Non-Government Organizations.** NGOs and other non-profit organizations are not immune to corruption and may be linked to political corruption.

PART II : METHODS OF CORRUPTION AND PREVENTIVE MEASURES

9. **Methods of Corruption.** Corruption can occur in many ways. The use of both positive and negative inducements to encourage the misuse of power is well known. In addition, favouring of friends and relatives in a way that is not directly beneficial to the corrupt individual, is a form of corruption. In systemic corruption and grand corruption, multiple methods of corruption are used concurrently with similar aims. Some of the methods of corruption are as under:-

(a) **Bribery.** Bribery is the improper use of gifts and favours in exchange for personal gain. This is also known as kickbacks or baksheesh. It is the most common form of corruption. The types of favours given are diverse and include money, gifts, sexual favours, company shares, entertainment, employment and political benefits. The personal gain that is given can be anything from actively giving preferential treatment to having an indiscretion or crime overlooked.

(b) **Embezzlement, Theft and Fraud.** Embezzlement and theft involves someone with access to funds or assets, illegally taking control of them. Fraud involves using deception to convince the owner of funds or assets, to give them up to an unauthorized party eg, misdirection of company funds into "shadow companies" and then into the pockets of corrupt employees, or the skimming of foreign aid money, scams and other corrupt activity.

(c) **Extortion and Blackmail.** While bribery is the use of positive inducements for corrupt aims, extortion and blackmail centre around the use of threats. This can be the threat of violence or false imprisonment as well as exposure of an individual's secrets or prior crimes. This also includes such behaviour as an influential person, threatening to go to the media, if they do not receive speedy medical treatment (at the expense of other patients), or threatening a public official with exposure of their secrets, if they do not vote in a particular manner, or demanding money in exchange for continued secrecy.

(d) **Abuse of Discretion.** Abuse of discretion refers to the misuse of one's powers and decision-making facilities. Examples include a judge improperly dismissing a criminal case or a customs official using their discretion to allow a banned substance through a port.

(e) **Favouritism, Nepotism and Clientelism.** This involves the favouring of not the perpetrator of corruption, but someone related to them, such as a friend, family member or member of an association. Examples would include hiring a family member to a role they are not qualified for, or promoting a staff member who belongs to the same political party as you, regardless of merit.

(f) **Improper Political Donations.** This is the use of contributions / donations to political parties to secure illicit power, not because one favours their policies. An example would be tobacco or alcohol companies funding major political parties, as a means of influencing the policing of their industry. It can be difficult to differentiate between proper and improper use of political contributions.

10. **Prevention of Corruption.** Removing corruption from our society is extremely difficult. However, some of the methods by which corruption can be reduced are:-

(a) Proper education of all sections of society that corruption in any form is bad and will not be tolerated.

(b) Don't give bribe or favours to any one nor take bribes / favours from any one.

(c) Highlighting / Reporting of cases of corruption.

(d) Speedy trial and exemplary punishment for persons involved in corruption.

- (e) Ensuring transparency in all dealings.
- (f) Dealing with corruption in higher echelons.
- (g) Strict implementation of the Prevention of Corruption Act.
- (h) Full freedom to Lok Pal or Lok Ayukt to investigate cases of corruption.
- (j) Simplifying routine procedures to prevent corruption.

CONCLUSION

11. Corruption in any form is bad and not acceptable. If we want to eradicate corruption, we must all take a pledge not to form part of the chain of corruption either as a 'giver' or as a 'taker'. Also we must ensure that, any person who makes a demand for bribes or gratification, must be promptly reported to the authorities for remedial action.

LESSON PLAN : SA 11
SOCIAL EVILS : FEMALE FOETICIDE, DOWRY
AND CHILD ABUSE / TRAFFICKING

Period	-	One
Type	-	Lecture
Code	-	SA 11
Term	-	II (SD/SW)

Training Aids

1. Computer, Projector, Charts, Pointer, Black Board & Chalk.

Time Plan

2.
 - (a) Introduction - 05 Min
 - (b) Female Foeticide - 10 Min
 - (c) Dowry - 10 Min
 - (d) Child Abuse - 10 Min
 - (e) Conclusion - 05 Min

INTRODUCTION

3. India is a large heterogeneous society with varied castes, cultural, religion and economic strata. Due to various customs, a large no of myths and beliefs are prevalent in the society. These have given birth to various kinds of social evils like dowry, female foeticide, gender bias, child abuse and trafficking etc.

AIM

4. To acquaint the cadets about the various types of Social Evils and their Prevention.

PREVIEW

5. The lecture will be conducted in following parts:-
 - (a) Part I - Female Foeticide.
 - (b) Part II - Dowry.
 - (c) Part III - Child Abuse.

PART I : FEMALE FOETICIDE

- (h) **Definition.** Female foeticide is the selective abortion / elimination of the girl child in the womb itself, done deliberately by the mother, after the detection of the child's gender through medical means. This is usually done under family pressure from the husband or the in-laws or even the woman's parents.

- (i) **Causes of Female Foeticide.** The main causes / reasons for female foeticide are:-
- (a) **Fanatic Desire / Preference to Have a Male Child.** Elimination / removal of girls from the family tree, even before they are born, clearly indicates the vehement desire for a boy child. The core factor is the need to continue the family line, through the male born into it. Sons are seen as the main source of income and the belief that they will look after the family and the old age parents.
- (j) **Unwanted Pregnancy.** Though most people cite this as an excuse for medical termination of Pregnancy (MTP) but, it is generally the course taken after sex determination test proves of a female foetus.
- (k) **©Foul Medical Ethics.** This process began in the early 1990s, when ultrasound techniques gained widespread use in India. There was a tendency for families to continue producing children, until a male child was born. Also, the unethical sex determination and selective abortion of female infants has become a booming US \$224 million industry, with lucrative incentives.
- (l) **Dowry System.** In India, the age old custom of 'dowry system' puts a damper on the parents' spirits who are 'blessed' with a girl child. Right then and there, begin the calculations associated with marriage expenses, which may happen after a couple of decades, following the child's first breath. Girls are seen more as a burden and some think that it would be so much better to get rid of them ,with just a fraction of the amount.
- (m) **Deteriorated Status of Women.** Centuries of repression has made 'inferiority' second nature to most women. They willingly embrace the role of the meek, submissive, docile wife, who works relentlessly to cater to the whims of her husband. Female foeticide happens with the explicit consent of the mother.
- (n) **Effects of Female Foeticide.**
- (a) **Skewed Sex Ratio.** In India, the number of girls per 1000 boys is declining with each passing decade. From 962 for every 1000 boys in the years 1981 the sex ratio had plummeted to an all time low of only 914 girls for 1000 boys in 2011.
- (b) **Female / Women Trafficking.** The steep decline in the number of girls makes them scarce for the teaming number of males eligible for marriage. As a solution to this issue, illegal trafficking of women has become commonplace in many regions. Women, often young girls who've just crossed the threshold of puberty, are compelled to marry for a price fixed by the groom-to be.
- (c) **Increase in Rape and Assault.** Once women become an endangered species, it is only a matter of time before the instances of rape, assault and violence become widespread. The legal system may offer protection, but as is the situation today, many cases might not even surface for fear of isolation and humiliation on the girl's part.
- (d) **Population Decline.** With no mothers or wombs to bear a child (male or female), there would be fewer births, leading to a decline in the country's overall population.

9. **Measures to Prevent Female Foeticide.** Of the numerous steps taken to curb the matter, the prominent ones are:-

- (a) Cancellation / permanent termination of the doctor's license who partakes in fulfilling a client's demand to do away with her girl child.
- (b) Heavy penalty imposed on companies like GE, that specialize in marketing medical equipments used for illegal sex determination and abortion in unlicensed clinics and hospitals.
- © High fines and judicial action against 'parents' who knowingly try to kill their unborn baby.
- (d) Widespread campaigns and seminars for young adults and potential parents to enlighten them about the ill effects of female foeticide. Ignorance is one of the major causes for the increase in the selective sex abortion cases. Spreading awareness can go a long way in saving our future sisters, mothers, girlfriends and wives.
- (e) High incentives for the girl child in education, employment etc.
- (f) Equal rights for women in the property of the parents / husband.

PART II : DOWRY

10. **General.** In India, **dowry** is the payment in cash or some kind of gifts given to bridegroom's family along with the bride. Generally they include cash, jewellery electrical appliances, furniture, bedding, crockery, utensils and other household items that help the newly-wed set up her home. As per the book "**Genocide of Women in Hinduism**" authored by Sita Agarwal, over the last 65 years, more than 50 million female children have been murdered as a result of Vedic dowry and infanticide laws. The **Dowry Prohibition Act 1961** states that: "If any person, gives or takes or abets the giving or taking of dowry, he shall be punishable with imprisonment for a term which shall not be less than five years, and with fine which shall not be less than fifteen thousand rupees or the amount of the value of such dowry, whichever is more."

11. **Causes of Dowry System.**

- (a) **Devine Sanction.** Dowry is one of the most ancient practices of India. **The Vedas prescribe** that a dowry be given by the bride's family to the groom. Thus, in order to marry Sita to Rama, her father had to supply her with 100 crores of gold mohurs, 10,000 carriages, 10 lakh horses, 60,000 elephants, 100000 male slaves, 50000 female slaves, 2 crores of cows, 100000 pearls, and many other items. Thus most people think that it is legal as per the vedic rights.
- (b) **Growing Economic Inequality.** This fuels the desire to ask for more and more cash or gifts to pursue a lavish life style or other ventures.
- © **Increasing Unemployment of Males.** In order to prove their status, unemployed males are growingly demanding more and more dowry to fulfill their desires.
- (d) **Parental Compulsions.** In order to find a good match for their daughter, well to do parents are offering huge dowry. This adds fuel to the growing demand for dowry.

12. **Effects of Dowry System.**

- (a) Increase in Domestic Violence.
- (b) Increase in Mortgage and Loans.

- © Female Foeticide.
- (d) Female Trafficking.
- (e) False Dowry Allegations.

13. **Prevention of Dowry.** Society and we as a member of the society can do a lot to prevent offences related to dowry by taking the following steps:-

- (a) Start practicing dowry prohibition in your family. Don't take or accept dowry.
- (b) Educate the members of your family with the provisions of law – that demanding and accepting or giving dowry is an offence.

© A woman is an important member of family and is entitled to all the rights and privileges a man enjoys. Educate the members of your family and your neighbors to respect a woman's rights and privileges.

- (d) Encourage women folk to raise their voice about their rights and to fight against dowry system.

PART III : CHILD ABUSE

14. **General.**

(a) India is home to almost 19 percent of the world's children. More than one third of the country's population, around 440 million, is below 18 years. According to one assumption 40 percent of these children are in need of care and protection, which indicates the extent of the problem. In a country like India with its multicultural, multi-ethnic and multi-religious population, the problems of socially marginalized and economically backward groups are immense. Within such groups the most vulnerable section is always the children.

(b) Child abuse is a state of emotional, physical, economic and sexual maltreatment meted out to a person below the age of eighteen and is a globally prevalent phenomenon. Child abuse is a violation of the basic human rights of a child and is an outcome of a set of inter-related familial, social, psychological and economic factors. Child abuse has serious physical and psycho-social consequences which adversely affect the health and overall well-being of a child.

15. **Definition.** According to WHO: "Child abuse or maltreatment constitutes all forms of physical and / or emotional ill-treatment, sexual abuse, neglect or negligent treatment or commercial or other exploitation, resulting in actual or potential harm to the child's health, survival, development or dignity in the context of a relationship of responsibility, trust or power.

16. **Forms of Child Abuse.** Child Abuse can be of following forms:-

(a) **Physical Abuse.** Physical abuse is inflicting physical injury upon a child. This may include hitting, shaking, kicking, beating, or otherwise harming a child physically.

(b) **Emotional Abuse.** Emotional abuse (also known as verbal abuse, mental abuse, and psychological maltreatment) includes acts or the failure to act by parents, caretakers, peers and others that have caused or could cause serious behavioural, cognitive, emotional, or mental distress/trauma.

© **Sexual Abuse.** Sexual abuse is inappropriate sexual behavior with a child. It includes fondling a child's genitals, making the child fondle an adult's genitals, sexual

assault (intercourse, incest, rape and sodomy), exhibitionism and pornography. To be considered child abuse, these acts have to be committed by a person responsible for the care of a child or related to the child (for example a baby-sitter, parent, neighbor, relatives, extended family member, peer, older child, friend, stranger, or a day-care provider).

(d) **Child Neglect.** Child neglect is an act of omission or commission leading to the denial of a child's basic needs. Neglect can be physical, educational, emotional or psychological. Physical neglect entails denial of food, clothing, appropriate medical care or supervision. It may include abandonment. Educational neglect includes failure to provide appropriate schooling or special educational needs. Psychological neglect includes lack of emotional support and love.

(e) **Unreasonable Deprivation.** Unreasonable deprivation of his/her basic needs for survival such as food and shelter, or failure to give timely medical treatment to an injured child resulting in serious impairment of his/her growth and development or in his/her permanent incapacity or death.

(f) Any other act, deed or word which debases, degrades or demeans the intrinsic worth and dignity of a child as a human being.

17. **Child Abuse in India.** A National Study on Child Abuse conducted in the year 2005 by the Ministry of Child and Women Welfare. This study, which is the largest of its kind undertaken anywhere in the world, covered 13 states with a sample size of 12447 children, 2324 young adults and 2449 stakeholders. It looked at different forms of child abuse: Physical Abuse, Sexual Abuse and Emotional Abuse and Girl Child Neglect in five different evidence groups, namely, children in a family environment, children in school, children at work, children on the street and children in institutions. The major findings of the study are as under:-

(a) It is the young children, in the 5-12 year age group, who are most at risk of abuse and exploitation.

(b) **Physical Abuse.**

(i) Two out of every three children were physically abused.

(ii) Out of 69% children physically abused, 54.68% were boys.

(o) Over 50% children were being subjected to one or the other form of physical abuse.

(iv) 88.6% children were physically abused by parents.

(v) 65% of school going children reported facing corporal punishment i.e. two out of three children were victims of corporal punishment. 62% of the corporal punishment was in government and municipal schools.

© **Sexual Abuse.**

(i) 53.22% children reported having faced one or more forms of sexual abuse.

(ii) 21.90% child respondents reported facing severe forms of sexual abuse and 50.76% other forms of sexual abuse.

(p) Out of the child respondents, 5.69% reported being sexually assaulted. Children on street, children at work and children in institutional care reported the highest incidence of sexual assault.

(iv) 7. 50% abuses are persons known to the child or in a position of trust and responsibility.

(v) Most children did not report the matter to anyone.

© **Emotional Abuse and Girl Child Neglect.**

(i) Every second child reported facing emotional abuse. Equal percentage of both girls and boys reported facing emotional abuse.

(ii) In 83% of the cases parents were the abusers.

(q) 48.4% of girls wished they were boys.

CONCLUSION

18. Social Evils are mostly born due to poor education, misplaced beliefs, unemployment and inequitable distribution of wealth. Social Evils are a disease on the society and have disastrous long term effects. We need to take concerted action to eradicate these evils from society. Although many laws / legislations presently exist to prevent the social evils, but the wholehearted participation of the people will only force their implementation. Hence we must all educate ourselves, as also our family and neighbours to take all necessary steps to eradicate all types of social evils from society.

LESSON PLAN : SA 12
RIGHT TO INFORMATION (RTI)
AND RIGHT TO EDUCATION (RTE)

Period	-	One
Type	-	Lecture
Code	-	SA 12
Term	-	III (SD/SW)

Training Aids

1. Computer, Projector, Charts, Pointer, Black Board & Chalk.

Time Plan

2. (a) Introduction - 05 Min
- (b) RTI - 15 Min
- © RTE - 15 Min
- (d) Conclusion - 05 Min

INTRODUCTION

- (r) Government of India is continuously working towards empowering its citizens through various legislations, acts, rules, programmes and projects. Some of the most prominent ones introduced in the recent past are the famous and powerful Right to Information (RTI) and Right To Education (RTE) acts. As we are aware, it is very essential for a person to have knowledge about the subject of interest, especially related to the Government, RTI is towards this end. Similarly, literacy or lack of it is a key factor for development of any nation. Enhancement of literacy, hence, is one of the primary duties of the Governments at Centre as well as States. RTE is towards this goal so that no one is denied an opportunity to get basic education.

AIM

- (s) To acquaint the cadets about Right to Information (RTI) & Right to Education (RTE).

PREVIEW

5. The lecture will be conducted in two parts as under:-
 - (a) Part I - RTI.
 - (b) Part II - RTE.

PART I : RIGHT TO INFORMATION (RTI) ACT 2005

6. The Indian Parliament had enacted the "Freedom of Information Act, 2002" in order to promote, transparency and accountability in administration. The National Common Minimum Program of the Government envisaged that "Freedom of Information Act" will be made more

“progressive, participatory and meaningful”, following which, decision was made to repeal the “Freedom of Information Act, 2002” and enact a new legislation in its place. Accordingly, “Right to Information Bill, 2004” (RTI) was passed by both the Houses of Parliament on May, 2005 which received the assent of the President on 15th June, 2005. “The Right to Information Act” was notified in the Gazette of India on 21st June, 2005. The “The Right to Information Act” became fully operational from 12th October, 2005. This new law empowers Indian citizens to seek any accessible information from a Public Authority and makes the Government and its functionaries more accountable and responsible.

7. **Important Provisions of the Act.**

(a) RTI mandates timely response to citizen requests for government information. It is an Act to provide for setting out the practical regime of right to information for citizens to secure access to information under the control of public authorities.

(b) In order to promote transparency and accountability in the working of every public authority, the constitution of a Central Information Commission and State Information Commissions are enshrined in the act.

© The Act covers the whole of India except Jammu and Kashmir, where J&K Right to Information Act is in force. It is applicable to all constitutional authorities, including the executive, legislature and judiciary; any institution or body established or constituted by an act of Parliament or a state legislature.

(d) It is also defined in the Act that bodies or authorities established or constituted by order or notification of appropriate government including bodies “owned, controlled or substantially financed” by government, or non-Government organizations “substantially financed, directly or indirectly by funds” provided by the government are also covered in it. Private bodies are not within the Act’s ambit directly.

(e) The Act empowers applicant citizens to:-

- (i) Obtain copies of permissible governmental documents.
- (ii) Inspect permissible governmental documents.
- (iii) Inspect permissible Governmental works and obtain samples.

10. **Exemptions.** The following information is exempt from disclosure:-

(a) Information, disclosure of which would prejudicially affect the sovereignty and integrity of India, the security, “strategic, scientific or economic” interests of the State, relation with a Foreign State or lead to incitement of an offense.

(b) Information which has been expressly forbidden to be published by any court of law or tribunal or the disclosure of which may constitute contempt of court.

© Information, the disclosure of which would cause a breach of privilege of Parliament or the State Legislature.

(d) Information including commercial confidence, trade secrets or intellectual property, the disclosure of which would harm the competitive position of a third party, unless the competent authority is satisfied that larger public interest warrants the disclosure of such information.

- (e) Information available to a person in his fiduciary relationship, unless the competent authority is satisfied that the larger public interest warrants the disclosure of such information.
- (f) Information received in confidence from foreign Government.
- (g) Information, the disclosure of which would endanger the life or physical safety of any person or identify the source of information or assistance given in confidence for law enforcement or security purposes.
- (h) Information which would impede the process of investigation or apprehension or prosecution of offenders.
- (i) Cabinet papers including records of deliberations of the Council of Ministers, Secretaries and other officers.
- (j) Information which relates to personal information the disclosure of which has no relationship to any public activity or interest, or which would cause unwarranted invasion of the privacy of the individual (but it is also provided that the information which cannot be denied to the Parliament or a State Legislature shall not be denied by this exemption).
- (k) Notwithstanding any of the exemptions listed above, a public authority may allow access to information, if public interest in disclosure outweighs the harm to the protected interests. (NB: This provision is qualified by the proviso to sub-section 11(1) of the Act which exempts disclosure of "trade or commercial secrets protected by law" under this clause when read along with 8(1)(d)).

PART II : RIGHT TO INFORMATION (RTI) ACT 20100

11. **General.**

- (a) Sixty-three years after independence, India Thursday, the 1st April 2010 enforced a historic Right to Education (RTE) act that promises freedom from illiteracy for this vast and diverse country. With this act, India became one of 135 countries to make education a fundamental right of every child.
- (b) The Act makes education "a fundamental right" of every child between the ages of 6 and 14 and specifies minimum norms in elementary schools. It requires all private schools to reserve 25% of seats to children from poor families (to be reimbursed by the state as part of the public-private partnership plan).
- © It also prohibits all unrecognized schools from practice, and makes provisions for no donation or capitation fees and no interview of the child or parent for admission.
- (d) The RTE act requires surveys that will monitor all neighbourhoods, identify children requiring education, and set up facilities for providing it. The RTE Act is the first legislation in the world that puts the responsibility of ensuring enrolment, attendance and completion of education on the Government.

12. **Main Highlights of RTE Act.** Following are the key points of the legislation:-

- (a) Free and compulsory education to all children of India in the six to 14 age group.
- (b) No child shall be held back, expelled, or required to pass a board examination until completion of elementary education (up to class eight).

- © A child who completes elementary education (upto Class 8) shall be awarded a certificate.
- (d) Calls for a fixed student-teacher ratio.
- (e) Will apply to all of India except Jammu and Kashmir.
- (e) Provides for 25 per cent reservation for economically disadvantaged communities in all private and minority schools.
- (f) Mandates improvement in quality of education.
- (g) School teachers will need adequate professional degree within five years or else will lose job.
- (h) School infrastructure (where there is problem) to be improved in three years, else recognition will be cancelled.
- (j) Financial burden will be shared between state and central government on the basis of Sarva Shiksha Abhiyan (Education for All).
- (t) Private schools to face penalty for violating RTE.

CONCLUSION

- (u) The powerful Acts of Government of India, RTI Act 2005 and RTE Act 2010 have been implemented with a sole aim of empowering the citizens of India. If implemented in a proper way, these acts will have the desired effects of bringing transparency & accountability in the public offices as well as literacy enhancement, particularly in rural India.

LESSON PLAN : SA 13
ANTI DRUNKEN DRIVING AND
TRAFFIC CONTROL ORG

Period	-	One
Type	-	Lecture
Code	-	SA 13
Term	-	II / III (SD/SW)

Training Aids

3. Computer, Projector, Charts, Pointer, Black Board & Chalk.

Time Plan

2.	(a)	Introduction	-	05 Min
	(b)	Traffic Control Organisation	-	15 Min
	©	Anti Drunken Driving	-	15 Min
	(d)	Conclusion	-	05 Min

INTRODUCTION

3. Expansion in the road network, surge in motorization and a rising population of a country contribute towards increasing numbers of road accidents, leading to injuries and fatalities. Road accidents are a human tragedy, which involve high human suffering. They impose a huge socio-economic cost in terms of untimely deaths, injuries and loss of potential income. The ramifications of road accidents can be colossal and its negative impact is felt, not only on individuals, their health and welfare, but also on the economy. Consequently, road safety has become an issue of national concern.

AIM

4. To acquaint the cadets about the Traffic Control Org and Anti Drunken Driving.

PREVIEW

5. The lecture will be conducted in following parts:-
- (a) Part I - Traffic Control Organisation.
- (b) Part II - Anti Drunken Driving.

PART I : TRAFFIC CONTROL ORGANISATION

6. The responsibility to control all traffic in a city or outside it is that of the Traffic Police department which works under the District police Chief. The Traffic Police carries out following tasks :-

- (a) Management and Regulation of all traffic.

- (b) Opening / closing of roads due to move of VIP or repairs or accidents.
- (c) Checking of vehicles documents for permits, licesne and ownership.
- (d) Checking of vehicles for overloading of passangers / load.
- (e) Ensuring proper marking and placement of road signs.
- (f) Conduct vehicle based patrolling of roads / highways.
- (g) Manning of road intersections, one way routes and check posts.
- (h) Manning of PRC vans.
- (j) Investigation of road accidents, making of accident reports and evacuation of injured to hospitals.
- (k) Clearing of road blockages due to accidents or any othe reason.
- (l) Educating general public on road safety rules.
- (m) Conduct of road safety seminars or training.
- (n) Speed monitoring dets.

7. **Traffic Organisation.**

- (a) The entire traffic in any city or town is controlled by the Deputy Commissioner of Police (Traffic). He is assisted by various Assistant Commissioner Police (ACPs), Inspectors, Assistant sub Inspectors (ASIs), Head Constables and Constables. The strength depends on the size of the city or town and the traffic that is to be managed.
- (b) For control of traffic, a city / town is divided into Zones and Divisions. Each Zone is under a ACP and a Division under an Inspector. In addition there is a Control Room, which monitors all Traffic Cameras and communications.

PART II : ANTI DRUNKEN DRIVING

General

8. An act of drunk driving can be described as driving a vehicle (including wheelchairs) under the influence of alcohol. Drunken driving is an offence in India, like many other countries worldwide. The object of making it an offence under law is to improve road safety by seeking to bring down the number of accidents and fatalities caused by driver's fault. We really can't blame the authorities for thinking that, what with daily news of some drunken late-night-partygoer mowing down footpath dwellers. With statistics saying that almost 78% of all road accidents in India are caused due to driver's fault. Drunk driving is the cause of approx. 39% of all casualties.

9. **Law.** In India, while driving a motor vehicle, if a person has a Blood Alcohol Level (BAC) exceeding 30 mg of intake per 100 ml of blood detected by a Breathalyzer, he or she is booked under '**first offense**'. This consists of imprisonment for a term, which may extend up to six months or with a fine up to two thousand rupees or both. For a second or subsequent offense, if committed within three years of the commission of the previous similar offense, he or she will face an imprisonment of a term, which may extend to two years, or with fine, which may extend to three thousand rupees or with both.

10. As per the Department of Road Transport and Highways, in 2011, there were a total of 4,92,686 road accidents in India which resulted in 5,27,512 deaths and 5,11,394 persons wounded. 'Drivers fault' resulted in nearly 78 % of these accidents. The intake of alcohol / drugs by drivers resulted in 31,000 road accidents and 9,976 fatalities. As a proportion of total accidents and deaths due to 'drivers' fault', intake of alcohol / drugs accounted for 8.0 per cent and 9.9 per cent, respectively.

11. The most common violators of drunk driving have been identified as under:-

- (a) Children between 16-25 yrs of age.
- (b) Most truck drivers.
- (c) Most people returning from pubs / parties in cities.
- (d) After New Year parties or Holi celebrations.

Prevention

12. The following measures can prevent deaths / accidents due to drunk driving:-

- (a) Don't drive after drinks under any circumstances.
- (b) Strict checking and penalty by police, if found drunk while driving.
- (c) Change of Laws to make it more serious a offence.
- (d) Report cases of drunk driving to police.

CONCLUSION

14. The role of Alcohol in traffic safety has produced more controversies than any other topic. After drinking, the judgment power of the driver gets impaired - a threat to road safety. Due to its effects, driver tends to take more risks, becomes more aggressive and takes a longer reaction time. It has been well established that the relative probability of causing crash increases with the rising blood alcohol levels keeping road safety at stake. Thus we must ensure that nither do we drive after drinking nor do we allow others to do this.

LESSON PLAN : SA 14
PROVISIONS OF PROTECTION OF CHILDREN FROM
SEXUAL HARRASMENT - ACT 2012

Period	-	One
Type	-	Lecture
Code	-	SA 14
Term	-	III (SD/SW)

Training Aids

2. Computer, Projector, Charts, Pointer, Black Board & Chalk.

Time Plan

2.	(a)	Introduction	-	03 Min
	(b)	Definitions and Provisions	-	10 Min
	(c)	Punishments	-	10 Min
	(d)	Method to Report and Record Cases	-	15 Min
	(e)	Conclusion	-	02 Min

INTRODUCTION

3. India is home to the largest child population in the world, and almost 42 per cent of its total population is under eighteen years of age. The health and security of the country's children is integral to any vision for its progress and development. One of the issues marring the vision for the country's children is the evil of child sexual abuse. In May 2012, the Protection of Children from Sexual Offences Bill 2012, was passed by Parliament. The Act received the President's assent on 19th June 2012 and was notified in the Gazette of India for public information on 20th June, 2012. The Act is to come into force on the 14th of November, 2012, along with the rules framed under the Act.

AIM

5. To acquaint the cadets about the "Protection of Children from Sexual Offences Act 2012".

PREVIEW

6. The lecture will be conducted in three parts as under:-
- | | | | |
|-----|----------|---|--------------------------------------|
| (a) | Part I | - | Definitions and Provisions. |
| (b) | Part II | - | Punishment under the Act. |
| (c) | Part III | - | Methods for Reporting and Recording. |

PART I : DEFINITIONS AND PROVISIONS

7. General Provisions.

- (a) The Act is gender-neutral and **defines a child as any person below the age of eighteen years.**
- (b) The Act provides precise definitions for different forms of sexual abuse, including penetrative and non-penetrative sexual assault, sexual harassment and pornography.
- (c) The Act provides for stringent punishment graded as per the gravity of the offence, with a maximum term of rigorous imprisonment for life for certain offences, and fine. It also prescribes punishment for a person if he provides false information with the intention to defame any person, including a child.
- (d) The Act provides for mandatory reporting of sexual offences.
- (e) The Act provides for child-friendly procedures for reporting of offences, recording of evidence, investigation and trial.

8. Under Section 45 of the Act, the power to make rules rests with the Central Government. The rules framed under the Act provide:-

- (a) Qualifications and experience of interpreters, translators, special educators, and experts; arrangements for care and protection and emergency medical treatment of the child.
- (b) Compensation payable to a child who has been the victim of a sexual offence. The compensation may be awarded at the interim stage, as well as upon completion of trial.
- (c) The manner of periodic monitoring of the provisions of the Act by the National Commission for Protection of Child Rights (NCPCR) and State Commissions for Protection of Child Rights (SCPCR).
- (d) Arrangements for the care and protection of the child and to ensure that the child is not re- victimised in the course of investigation and trial.
- (e) That where a child is taken to a medical facility for emergency medical care, no magisterial requisition or other documentation may be demanded by such facility prior to rendering medical care.

9. The **National Commission for the Protection of Child Rights (NCPCR)** and **State Commissions for the Protection of Child Rights (SCPCRs)** have been made the designated authority to monitor the implementation of the Act.

PART II : PUNISHMENT UNDER THE ACT

10. The Act provides for stringent punishments, which have been graded as per the gravity of the offence. The punishments range from simple to rigorous imprisonment of varying periods. There is also provision for fine, which is to be decided by the Court.

11. The act also recognizes that the **intent to commit an offence, even when unsuccessful for whatever reason, needs to be penalized.** The attempt to commit an offence under the act has been made liable for punishment for up to half the punishment prescribed for the commission of the offence.

12. The act also provides punishment for abetment of the offence, which is the same as for the commission of the offence. This would cover Trafficking of the children for sexual purposes.

13. **Punishment for Offences Covered in the Act.** These are as under:-

- (a) **Penetrative Sexual Assault (Section 3).** Not less than seven years imprisonment, which may extend to imprisonment for life and, fine (Section 4).
- (b) **Aggravated Penetrative Sexual Assault (Section 5).** Not less than ten years imprisonment, which may lead to imprisonment for life and, fine (Section 6).
- (c) **Sexual Assault (Section 7).** Not less than three years imprisonment, which may extend to five years and, fine (Section 8).
- (d) **Aggravated Sexual Assault (Section 9).** Not less than five years imprisonment, which may extend to seven years, and fine (Section 10).
- (e) **Sexual Harassment of the Child (Section 11).** Three years imprisonment and fine (Section 12).
- (f) **Use of Child for Pornographic Purposes (Section 13).** Five years imprisonment and fine , and in the event of subsequent conviction, seven years imprisonment and fine (Section 14 (1)).

PART III : METHODS FOR REPORTING AND RECORDING

14. **General Provisions.**

- (a) It is necessary for the proper development of the child that, his or her right to privacy and confidentiality be protected and respected by every person by all means and through all stages of a judicial process involving the child.
- (b) The media has been barred from disclosing the identity of the child without the permission of the special court.
- (c) For speedy trial the act provides the evidence of the child to be recorded within a period of 30 days. Also, the special court is to complete the Trial within a period of one year, as far as possible.
- (d) The SJPU or the local police are also required to report the matter to the child welfare committee within 24hrs of recording the complaint, for long term rehabilitation of the child.
- (e) The Act provides for the establishment of Special Courts for trial of offences under the Act, keeping the best interest of the child as of paramount importance at every stage of the judicial process.

15. **Reporting and Recording of Evidence.** The Act incorporates child friendly procedures for reporting, recording of evidence, investigation and trial of offences. These include:-

- (a) Recording the statement of the child at the residence of the child or at the place of his choice, preferably by a woman police officer not below the rank of sub-inspector.
- (b) No child to be detained in the police station in the night, for any reason.
- (c) Police officer will not be in uniform, while recording the statement of the child.

- (d) The statement of the child to be recorded, as spoken by the child.
- (e) Assistance of an interpreter or translator or an expert be provided as per the need of the child.
- (f) Assistance of special educator or any person familiar with the manner of communication of the child in case child is disabled.
- (g) Medical examination of the child to be conducted in the presence of the parent of the child or any other person in whom the child has trust or confidence.
- (h) In case the victim is a girl child, the medical examination shall be conducted by a woman doctor.
- (i) Frequent breaks for the child during trial.
- (j) Child not to be called repeatedly to testify.
- (k) No aggressive questioning or character assassination of the child.
- (l) In-camera trial of cases.

CONCLUSION

16. We have a very large population of children in our country and many of them require protection of various kinds. The Protection of Children from Sexual Offences Act 2012, is an important milestone and it is our moral responsibility, that we educate our children about the act and the provisions enshrined in it.

INDEX**HEALTH & HYGIENE**

<u>Ser No</u>	<u>Lesson Code</u>	<u>Subject</u>	<u>Cat</u>	<u>Page No</u>
1.	H 1	Structure & Functioning Of The Human Body	SD/SW	215
2.	H 2	Hygiene & Sanitation (Personal & Food Hygiene)	SD/SW	218
3.	H 3	Physical & Mental Health	SD/SW	225
4.	H 4	Infectious & Contagious Diseases & Its Prevention	SD/SW	228
5.	H 5	First Aid In Common Medical Emergencies	SD/SW	233
6.	H 5	Basics Of Home Nursing (III Term)	SD/SW	241
7.	H 6	Treatment and Care of Wounds	SD/SW	247
8.	H 6	Treatment and Care of Fractures (III Term)	SD/SW	250
9.	H 7	Introduction To Yoga Exercises	SD/SW	255

LESSON PLAN : H 1
STRUCTURE AND FUNCTION OF THE HUMAN BODY

Period	-	One
Type	-	Lec
Code	-	H 1
Term	-	I (SD/SW)

Training Aids

1. Computer Slides, Pointer, Charts, Black Board and Chalk.

Time Plan

2. (a) Introduction - 05 Min
- (b) Skeletal and Muscular System - 10 Min
- (c) Organ Systems - 20 Min
- (d) Conclusion - 05 Min

INTRODUCTION

3. The human body is the greatest of all complex machineries. In order to carryout first aid, a first aider should have basic idea of structure and function of every part of the human body. Many lives can be saved if proper and timely first aid can be rendered.

AIM

4. To teach the NCC cadets about the Structure and Functioning of the Human Body.

PREVIEW

5. The class will be conducted in the following parts:-
 - (a) Part I - Skeletal and Muscular System.
 - (b) Part II - Organ Systems.

PART I : SKELETAL AND MUSCULAR SYSTEM

Skeletal System

6. **Structures of Bones.** The human body has 206 bones of various shapes and sizes. The bones give shape and firmness to the body, as also it protects the vital organs like brain, heart, lungs spinal cord. Bones can either be 'loosely arranged' or 'densely arranged'. The loosely arranged bone is called 'spongy bone' and densely arranged bone is called 'compact bone'. Some bones are hollow from inside and filled with bone marrow.
7. **Classification of Bones.** Bones can be classified according to their shape as under:-
 - (a) **Long Bones.** These bones are long and tubular and are confined to upper / lower limbs.
 - (b) **Short Bones.** This bones are short and tubular and are found in the ankle / wrists.

- (c) **Flat Bones.** These bones are flat like plates, e.g. bones of cranium (Skull), shoulder or hips.
- (d) **Irregular Bones.** Irregular or mixed shape, eg. vertebral column.
- (e) **Sesamoid Bones.** They develop in the tendons of the muscles around the joint. eg. patella.

Muscular System

8. The muscle forms about half of the total weight of the body and are responsible for body movement. The muscles form the 'flesh' of the body are under the control of nervous system.
9. **Classification.** The muscles of the body are classified into the following types:-
- (a) **Voluntary/Skeletal Muscles.** Voluntary muscles or skeletal muscles are attached to the surface of bones. These muscles form about 47% of the body weight and are either fiber type or striated type. Most of the skeletal muscles span from one bone to another across a joint and by contracting, they act upon the joints and produce movements.
 - (b) **Involuntary Muscles.** These are called involuntary muscles, because they are controlled by the autonomic nervous system.
 - (c) **Cardiac Muscles.** Though cardiac muscles are striated structurally, they form the main part of heart wall.

PART II : ORGAN SYSTEMS

10. **Circulatory System.** The circulatory system consists of the Heart, Blood Vessels and Blood. Each time the heart contracts, blood is pumped along the blood vessels. It is therefore kept in a state of continuous motion. By blood circulation, oxygen, nutrients and other substances are brought to the tissues and the waste products and carbon dioxide formed by the tissue are constantly removed.

- (a) **Heart.** The Heart is the most important organ of blood circulation. It is situated in thorax between the lungs and on to the left side of the body. The size of heart is equal to a clenched fist and the average wt of heart in a male is about 300 gms, and in a female about 250 gm. It is divided into two compartments, the right and the left. The right side contains impure blood while left side contains pure blood. Each side is again divided into AURICLES and VENTRICLES. Auricles are the receiving chambers.
- (b) **Blood.** The blood is also known as the 'transport system' of the body, and plays an important role in maintenance of life. The total volume of blood contains – hemoglobin, RBC, WBC & platelets.
- (c) **Blood Vessels.** Blood vessels are tube like structures which carry blood all over the body for circulation. These are of three types:-
 - (i) **Arteries.** These are the blood vessels which carry pure blood from the heart to all parts of the body.
 - (ii) **Capillaries.** These are tiny blood vessels which connect the small arteries & veins. The exchange of oxygen and nutrition with carbon dioxide by the tissue takes place in the capillaries.
 - (iii) **Veins.** These blood vessels carry impure blood to the heart. The main veins are called 'superior' and 'inferior' vena cava.

11. **Respiratory System.** Respiration or breathing is a process by which, oxygen, obtained from fresh air, is absorbed in to the blood stream and carbon dioxide, formed by the tissue action,

is removed from the blood and expelled into the air, that is then expired. It is a process essential to life. It involves the taking in of oxygen and giving out of carbon dioxide. The main organs of respiratory system are Nose, Pharynx, Larynx, Trachea, Bronchi, and the Lungs.

12. **Digestive System.** Digestion is a mechanical and chemical process by which, complex food substances are converted into simple substances so that they can be easily absorbed by blood and utilized by the various tissues of the body according to their requirements. The main organs of digestive system are mouth, salivary glands, pharynx, esophagus, stomach, pancreas, liver, small intestine and the large intestine

13. **Excretory System.** Excretion is a process by which waste products are removed out of the body. Among the organs that contribute towards the elimination of waste products are the skin, lungs, kidneys and the gastro-intestinal tract.

(a) **Skin.** The skin covers the external surface of the body. Waste matter in the form of sweat is removed through perspiration by the skin.

(b) **Urinary System.** The main organs of the urinary system are:-

(i) **Kidneys.** There are two bean shaped organs situated on the posterior abdominal wall in the lumbar region. They act as filters in the body, to filter the waste.

(ii) **Ureters.** Ureters are two tubes, which carry the urine from kidney to Urinary bladder.

(iii) **Urinary Bladders.** It is a hollow muscular organ situated in the pelvic cavity. It is a freely movable organ. Its size and shape varies according to the amount of urine it contains. It stores the urine.

(iv) **Urethra.** It is a tube leading from the floor of the urinary bladder to the exterior. It is used for excretion of the urine from the body.

14. **Nervous System.** Internal Balance of the human body is maintained within normal limits by the nervous system and the endocrine system. The nervous system may be sub divided into three main portions:-

(a) **The Central Nervous System.** This consists of brain and spinal cord.

(b) **The Peripheral Nervous System.** This forms the connections between the central nervous system and the various organs and muscles.

(c) **The Autonomic Nervous System.** It is an offshoot of the central nervous system and controls the involuntary functions of the various internal organs such as the stomach, intestine bladder and also the tiny muscles of the blood vessels and also controls the secretions of the Liver and Kidneys. A person is neither conscious for the normal activities of the autonomic system nor is he able to control them.

CONCLUSION

15. Basic knowledge of our body systems allows us to understand the field of health and hygiene with ease. This knowledge provides us the basic framework on which subsequent knowledge and skills dealing with medical science can be gained in a progressive manner.

LESSON PLAN : H 2
HYGIENE AND SANITATION

Periods	-	Two
Type	-	Lec
Code	-	H 2
Year	-	I / III (SD/SW)

Training Aids

1. Computer Slides, Pointer, Charts, Black Board and Chalk.

Time Plan

2. (a) Introduction - 03 Min
- (b) Hygiene - 40 Min
- (c) Sanitation - 35 Min
- (d) Conclusion - 02 Min

INTRODUCTION

3. Hygiene and Sanitation are fields of medical science which aim to preserve and improve the health of the Individual and of the community as a whole. Its study is aimed at making the cadets aware of the many preventable health hazards and to enable them to look after themselves and their community most efficiently. It seeks to develop in them the concepts of healthy living. This field has nothing to do with religion or social customs but it is simply based on scientific requirements. Personal hygiene involves all aspects of the health of an individual. Responsibility for the maintenance of personal health therefore lies with the individual. Every person must remain in perfect physical, mental and social health, only then can he serve the community and the country well.

AIM

4. To teach the NCC cadets about Hygiene and Sanitation.

PREVIEW

5. The class will be conducted in the following parts:-
 - (a) Part I - Hygiene.
 - (b) Part II - Sanitation.

PART I : HYGIENE

Personal Hygiene

6. Maintenance of personal hygiene is very important in preventing disease. It deals with the practices that help in the maintenance and promotion of a person's health. Personal Hygiene helps in the following:-

- (a) To maintain a good and clean physique.

- (b) To maintain good muscle strength.
- (c) To maintain clean mouth and teeth.
- (d) To maintain resistance to prevent infection.

7. **Main Components.** The main components of personal hygiene are:-

- (a) **Sleep.** Sleep means the periodical rest of both body and mind and it is extremely essential for a healthy body. The amount of sleep one requires varies with individual age. The average requirement of sleep is about 7 to 8 hours a day.
- (b) **Bathing.** Keeping the skin clean and in healthy condition is essential for good health. A bath with a mild soap with warm water in winters and cool water in summers are essential for body cleaning. While bathing, all parts of the body including folds in the skin must be cleaned well. After the bath, the body must be dried properly including the folds in the skin as wetness or dampness will lead to cuts /fungal infection.
- (c) **Eating and Drinking.** Properly cooked food with its full nutrient value is beneficial for health. Eat slowly and chew well. Do not swallow hastily. Drink plenty of water between meals and avoid strenuous exercise after a heavy meal.
- (d) **Care and Cleanliness of Skin, Hair and Teeth.** Our skin keeps on secreting sweat and hence it is necessary to keep it clean through bathing and by removing dust and dirt.. Regular changing and cleaning of clothing is essential to keep the body fit. Digestive and other disorders take place when decayed teeth and unhealthy gums bleed giving foul smell in the mouth. Teeth should be regularly brushed after the last meal at night and early in the morning. In – sufficient vitamins C & D are the cause of dental decay.
- (e) **Exercise.** Organized games and physical exercise are necessary for proper development of the body and mind.

8. **Water Supply and Its Purification.**

- (a) **Sources of Water Supply.** The main sources of water supply are:-
 - (i) **Rain Water.** Most of the fresh water on earth comes from rains. However, most of this water is not fit for consumption due to impurities of the atmosphere.
 - (ii) **Surface Water.** Surface water is found mainly in rivers and streams or lakes. This water is unfit for human consumption without treatment due to discharge of various types of wastes into it.
 - (iii) **Underground Streams.** Bore Wells are a good source of potable water supply. However, even these need to be protected from contamination.
- (b) **Purification of Water.** Safe drinking water comes only from an authorized source. Purification provides good and safe water by eliminating the suspended matter, harmful salts in solution, bad taste/smell, undesirable colors and germs. The following methods are used for water purification:-
 - (i) **Boiling and Filtering Water.** Untreated or treated potable water from any unreliable source must be boiled at 100 degrees for 30 min, cooled and then filtered. Only then will it be fit for consumption.
 - (ii) **Clarification.** This is the removal of suspended matter through filtration, by passing it through filter beds of gravel and sand or through properly sterilized filters.
 - (iii) **Sterilization.** This is done by using chlorine gas or bleaching powder.
 - (iv) **Pinking.** During cholera epidemic potassium permanganate should be used for pinking of wells.

- (v) **Precipitation.** This is done by adding alum or some similar chemical to water, which makes all impurities accumulate at the bottom and leaves pure water. This water is then passed through a filter.

Food Hygiene

9. Food is a potential source of infection and is liable to contamination by microorganisms at any point during its journey from the producer to the consumer. Prevention of contamination of food has to be observed from production to handling, distribution and serving. The following are the important components of food hygiene:-

(a) **Milk Hygiene.** Milk is an efficient vehicle for many disease organisms. Contamination of milk may be due to infected animal, human handler or environmental factors. Following aspects should be ensured to obtain clean and safe milk:-

- (i) The animal and its surroundings should be healthy and clean. The animal should be properly washed before milking.
- (ii) Milk handler should be free from any communicable disease.
- (iii) Milk vessels should be totally clean, sanitized and kept covered.
- (iv) Water supply must be safe.

(v) **Pasteurization.** It is the heating of milk to such temperature and for such periods of time, as are required to destroy any pathogens without destruction of nutritive value. It does not alter taste. (Temperature 130 C and time 1 to 2 seconds).

(b). **Meat Hygiene.** The word meat includes various tissues of animal origin. The diseases which may be transmitted through meat are 'Tapeworm Infestation' and 'Bacterial Infections' like anthrax, tuberculosis or food poisoning. The animal intended for slaughter, must be subjected to proper ante mortem and post mortem inspection. Good meat should neither be pale pink nor deep purple nor should it be slimy. Good meat should be elastic to touch and should have agreeable color.

(c) **Fish Hygiene.** Fish for human consumption should be fresh. In fresh fish, the gills are bright red and the eyes are clear and prominent. Consumption of contaminated fish may give rise to fish poisoning.

(d) **Egg Hygiene.** Though the majority of freshly laid eggs are sterile inside, the eggshell may become contaminated by fecal matter from the hen. The egg must be properly washed before cooking.

(e) **Fruits and Vegetables Hygiene.** Fruits and vegetables are an important source for the spread of pathogenic organisms, protozoan and helminthes. Fruits and vegetables consumed raw must be washed well before eating.

(f) **Hygiene of Eating Places.**

- (i) Eating places should not be located near filthy places, open drains, animal sheds, manure /soakage pits and other such places.
- (ii) Floors should be easy to clean, and should be preferably tiled.
- (iii) Rooms for storage of food should be well ventilated, insect and rat proof and should have adequate lighting.
- (iv) Perishable and non perishable items should be kept separately.
- (v) Furniture should be strong and easy to clean.

- (vi) Refuse should be collected in covered bins and removed regularly.
 - (vii) Water supply should be independent, adequate and safe.
 - (viii) Proper place for cleaning of utensils should be provided.
- (g) **Hygiene of Food Handlers.**
- (i) Complete medical examination of food handlers must be done at the time of employment.
 - (ii) Regular health checkups should be done.
 - (iii) Education of food handlers should be regularly educated on health and hygiene aspects.
 - (iv) They should be constantly reminded about hand washing, trimming of nails, covering of hair, wearing of overalls and covering mouth while coughing and sneezing during cooking.

PART II : SANITATION

10. **Definition.** Sanitation means keeping the living area and its surroundings neat and clean. This involves removal of waste products and refuse.

Waste Products / Refuse

11. **Types.** Some types of the waste products are :-

- (a) Human excreta - faeces & urine.
- (b) Stable litter - horses & cow dung.
- (c) Dry refuse & garbage - household, municipality, industrial & agricultural.
- (d) Liquid wastes: household sullage, municipal & industrial effluent.
- (e) Offensive trade wastes.
- (f) Dead animals, carcasses & offal of slaughtered animals.

12. **Sources of Refuse .**

- (a) **Street Refuse.** Refuse that is collected by street cleansing service or scavenging is called street refuse e.g. leaves straw paper etc.
- (b) **Market Refuse.** Refuse that is collected from markets is called market refuse. e.g. spoiled vegetable and animals matter.
- (c) **Stable Litter.** It contains mainly animal dropping and left over animal feeds.
- (d) **Industrial Refuse.** Industrial refuse comprises of a wide variety of waste ranging from
- (e) **Domestic Refuse.** The domestic refuse consist of ash, rubbish and garbage.

Disposal of Waste Products / Refuse.

13. **Collection and Removal of Refuse.**

- (a) **House Hold Refuse.** Covered galvanized irons bins are placed on brick / cement platforms at convenient distances from the house. These should be used for dumping

house hold refuse. This refuse is then collected in covered wheel barrows or municipal vans to prevent blowing out by air.

(b) **Special Refuse.** This is from stables and cowsheds. It is collected in carts and taken to disposal ground at frequent intervals.

(c) **Street Refuse.** Covered dustbins should be placed at suitable intervals along the street and all the sweeping should be dumped in it. It is then collected early morning in covered vans.

14. **Disposal of Refuse.** Various methods for disposal of refuse are:-

(a) **Filling.** In this method the refuse is generally utilized in filling up pits, unsanitary tanks or in reclaiming low land. The area selected should be at least 100-150 feet away from any habitation. No refuse should be left uncovered for more than 72 hrs.

(b) **Controlled Tipping.** Controlled tipping or sanitary landfill is the most satisfactory method of refuse disposal where suitable land is available. Chemical, bacteriological and physical changes occur in buried refuse.

(c) **Incineration.** Hospital refuse, which is particularly dangerous, is best disposed off by incineration .

(d) **Composting.** It is a method of combined disposal of refuse and night soil or sludge.

(e) **Manure Pits.** The garbage, cattle dung, straw and leaves should be dumped into the manure pits and covered with earth, after each days dumping.

(f) **Burial.** This method is suitable for small camps. A trench 1-5m wide and 2m deep is excavated. When the level in the trench is 40 cm from ground level, the trench is filled with earth and composted.

(g) **Sorting.** This method consists of storing_refuses in three separate parts for easy disposal:-

(i) **Breeze.** Cinders and pieces of coal are used for making bricks.

(ii) **Soft Core.** Animal and vegetable organic matter, which is used as manure.

(iii) **Hard Core.** Broken bottles and crockery is used for metaling of roads.

15. **Disposal of Human Waste.** Proper disposal of human night soil / excreta are very essential for prevention of various communicable diseases and also to prevent pollution / contamination of soil, water or food (through flies). Various methods are available for disposal of human waste / excreta as per the type of area ie, area with a proper sewage system (sewered areas) and areas without proper sewage system (unsewered areas).

(a) **Sewered Areas.** The latrines used in such areas are mainly the **Flush Latrines.** It implies that ample supply of water is available to flush the night soil away. It is simple and hygienic.

(b) **Unsewered Areas.** There are of various types latrines for such areas:-

(i) **Domestic Latrines.** These are those latrines which are used in houses in areas not having a sewage system. These are of following types:-

(aa) **Bore Hole Latrine.** The latrine consists of a circular hole 30-40 cm in diameter dug vertically in the ground to a depth of 4 to 8 mtr. In loose

sandy soil the hole is lined with bamboo matting or earthenware lining.

(ab) **Dug Well Latrine.** A circular pit about 75 cm in diameter and 3 to .5 cm deep is dug into the ground for the reception of the night soil . In sandy soil the depth of the pit may be reduced to 1.5 to 2 mtr.

(ac) **Water Seal Latrine.** The water seal performs two important functions e.g. it prevents access to flies and it prevents escape of foul odour. Out of many designs of water seal latrines, the RCA type is widely adopted.

(ii) **Camp Latrines.** These are of following types:-

(aa) **Deep Trench Latrines.** A pit three feet wide, at least eight feet deep and of a length suitable to the requirement is constructed and wooden seats placed over it with proper partitions and curtains. Soil may necessitate reverting of sides with sand bags, bamboos or wire netting. On vacation of camp, these are filled up with soil to assist in disintegration and prevent breeding of flies.

(ab) **Shallow Trench Latrines.** For camps of less than a week's duration, dig a row of trenches in parallel, each trench being 3 feet long, 1 foot wide and 2 feet deep. Each trench should be 2 feet apart. The ratio is 5 trenches for the first hundred users and three for each subsequent hundred. After defecation, the excreta is covered with loose earth with a shovel or a scoop. These trenches are filled up after 24 hours and new trenches are dug up.

(ac) **Urinals.** The most common urinal used for camps is the **Funnel Urinals** which are constructed over a simple soakage pit.

(c) **Soakage Pits.** These are essential for the disposal of liquid refuse like greasy water from kitchen and waste water from bathrooms. Dig a pit 4 feet by 4 feet and 5 feet to 6 feet deep. Fill with small stones and broken bricks. Cover the top with oiled sacking and put earth or sand 6 inches above. In the centre keep a perforated empty tin of kerosene oil. Fill this tin with layers of gravel or sand and gravel. In this fit remove the strainer daily and replace with fresh one.

(d) **Disposal of Garbage.** Disposal of solid refuse like kitchen garbage, bones etc, be done by burial or burning. The household refuse should be deposited in a covered bin placed outside. Improvised kerosene/oil tins are not advisable. Further disposal should be done under municipal arrangements.

16. **Disposal of Sewage.** Proper disposal and treatment of sewage has assumed great importance today. The disposal of sewage involves treatment and disposal as under :-

(a) **Treatment of Sewage.** Treatment of sewage is brought about by the action of anaerobic and aerobic bacteria. The different steps involved in this process are:-

- (i) Screening.
- (ii) Chambering.
- (iii) Primary Sedimentation.
- (iv) Trickling Filter.
- (v) Activated Sludge Process.

- (vi) Sludge Digestion.
 - (vii) Disposal of Effluent.
- (b) **Disposal of Sewage.** The sewage is collected by the water carriage system and where no treatment facility is available can be disposed off by:-
- (i) **Sea Out Fall.** The sewage is drained into the sea. This is applicable mostly for coastal cities / towns.
 - (ii) **River Out Fall.** The sewage is drained into the river. This is applicable mostly for cities / towns situated along the rivers or connected by drains.
 - (iii) **Land Treatment.** Here the sewage is allowed to drain out on the earmarked land / pits. This is mostly applicable to small villages.
 - (iv) **Oxidation Pond.**

CONCLUSION

17. Hygiene and Sanitation are two sides of a coin, which must be ensured together for best results. These are simple steps which, if taken regularly and correctly can be beneficial to both individuals and community as investing of time and effort in them can lead to saving of lives.

LESSON PLAN : H 3
PHYSICAL AND MENTAL HEALTH

Period	-	One
Type	-	Lec
Code	-	H 3
Year	-	III (SD/SW)

Training Aids

1. Computer Slides, Pointer, Charts, Black Board and Chalk.

Time Plan

2. (a) Introduction - 03 Min
- (b) Physical Health - 15 Min
- (c) Mental Health - 20 Min
- (d) Conclusion - 02 Min

INTRODUCTION

3. Earlier doctors defined health simply as 'an absence of disease or illness'. However, after the formation of World Health Organization (WHO) in 1948, health is defined as 'a complete state of physical, mental and social well being' and not merely the absence of disease or infirmity'. The mind and body are single system.

AIM

4. To teach the NCC Cadets about the importance of Physical and Mental Health.

PREVIEW

5. The class will be conducted in the following parts:-
 - (a) Part I - Physical Health.
 - (b) Part II - Mental Health.

PART I : PHYSICAL HEALTH

6. Physical health is the absence of disease and infirmity and it is assessed by taking health state measurements of the body.
7. **Elements of Good Health.** Good health is an essential condition for a purposeful existence. The main elements good health are:-
 - (a) Absence of disease.
 - (b) Ability to work hard with efficiency and enthusiasm.
 - (c) Ability to endure stress and strain.

- (d) Cheerfulness.
- (e) Courage.
- (f) Freedom from anxiety.
- (g) Self control and self confidence.
- (h) Sense of well being.
- (j) Wholesome mental attitude.

PART II : MENTAL HEALTH

8. **Importance of Mental Health.** Mental health refers to the successful performance of mental functions, resulting in productive activities, fulfilling relationship with other people, ability to adopt to change and cope up with adversities. It is of paramount importance, to lay due emphasis on the development of mental health of children. Any disregard to this may lead to mental disorder and conflicts, which ultimately may bring frustration, misery and unhappiness. Parents and teachers play a major role in providing an environment in which children develop healthy mental attitude.

9. **Characteristics of a Healthy Mind.** These are:-

- (a) Normal appetite.
- (b) Calmness.
- (c) Cheerful outlook.
- (d) Good temper.
- (e) Socially acceptable habits.
- (f) Well regulated instincts.
- (g) Normal physical vitality.
- (h) Receptivity to new ideas.
- (j) Sex consciousness.

10. **Mental Disorders.** Following are some of the indicators of mental disorders:-

- (a) Undue anxiety.
- (b) Embarrassment in presence of others.
- (c) Lack of courage.
- (d) Undeveloped habits and will.
- (e) Low intelligence.
- (f) Depressed and pessimistic outlook.
- (g) Moodiness.

- (h) Bad temper.
- (j) Full of prejudice.

11. **Measures to Improve Mental Health.** Following measures will help in improving mental health:-

- (a) Favorable and stress free home and school environment.
- (b) Regular medical examination.
- (c) Provision of educational and vocational guidance / counseling.
- (d) Provision of co-curricular activities.

CONCLUSION

12. Health is very important aspect for all living beings. Human have a tendency to get into bad life styles due to facilities available to them which results in their poor health .The subject of health must be understood by all of us to remain in good health.

LESSON PLAN : H 4
INFECTIOUS & CONTAGIOUS DISEASES AND ITS PREVENTION

Period	-	Two
Type	-	Lec
Code	-	H 4
Year	-	I (SD/SW)

Training Aids

1. Computer Slides, Pointer, Charts, Black Board and Chalk.

Time Plan

2. (a) Introduction - 03 Min
- (b) Classification of Diseases - 35 Min
- (c) Preventive Measures - 40 Min
- (d) Conclusion - 02 Min

INTRODUCTION

3. Many of the deadly diseases can be prevented from spreading to healthy persons if proper precautions are taken by checking infection and contagion of several diseases and by killing carriers of several other diseases.

AIM

4. To teach the NCC cadets about the different types of Infectious and Contagious Diseases and their Prevention.

PREVIEW

5. The class will be conducted in the following parts:-
 - (a) Part I - Classification of Diseases.
 - (b) Part II - Preventive Measures.

PART I : CLASSIFICATION OF DISEASES

6. Communicable diseases can be classified as follows:-
 - (a) **Excremental Diseases**. These are those diseases which are communicated or transferred through human excreta (urine and faeces). The excreta can contaminate food, water or hands of cooks and thus pass on the infection. Typhus fever, dysentery, diarrhoea, jaundice and intestinal worms are some of the important diseases belonging to this group.
 - (b) **Droplet Infection**. These are those diseases which are communicated or transferred through germs which are sprayed out from the nose, throat or lungs in the air, in small droplets of saliva during coughing, sneezing or even while talking. These germs are inhaled by a healthy man if he happens to be near the sick. Common cold, influenza,

diphtheria, meningitis, (inflammation of the brain) and tuberculosis are the common diseases in this group.

(c) **Contact Diseases.** These are those diseases which are communicated or transferred when the germs pass from a sick person to a healthy person by actual body contact. Venereal diseases i.e. syphilis, gonorrhoea and skin infection are some common examples.

(d) **Insect Borne Diseases.** These are those diseases which are communicated or transferred when the germs move from a sick person to a healthy person through Blood sucking insects known as 'Carriers'. These insects first bite a sick person and then bite a healthy person, transferring the germs of the diseases in the blood of the healthy person. These germs then multiply in the blood of the healthy person during the period of incubation, and at the end of which he starts showing symptoms of the disease carried by the insect. Some of the carrier insects and their disease are:-

- (i) Mosquito - Malaria, Dengue and Filariasis.
- (ii) Sand fly - Sand fly fever, Kala Zar, Oriental Sore.
- (iii) Lice - Typhus, Relapsing Fever.
- (iv) Flies - Diarrhoea, Dysentery, Cholera, Typhoid.
- (v) Fleas - Plague, Typhus.
- (vi) Ticks - Relapsing Fever, Typhus.

(f) **Water Borne Diseases.** Certain diseases spread due to infection carried through water. These are cholera, dysentery, diarrhoea, jaundice etc. These spread as water gets contaminated through vomits or faeces passing into it. Epidemics are likely to spread if immediate steps are not taken to disinfect water and to properly dispose off the excreta through efficient conservancy arrangements. All sources of the diseases ought to be eliminated.

(g) **Animal Borne Diseases.** The germs are transmitted through the agency of animals by drinking milk or through the agency of insects. Rabies, plague, anthrax and tuberculosis are some of the common diseases.

PART II : PREVENTIVE MEASURES

7. Specific measures to prevent diseases are as under:-

(a) **Prevention of Excremental & Water Borne Disease.**

- (i) Control of water route is easy by disinfecting water or providing safe water in place.
- (ii) Control of the milk route is easy by subjecting the milk to boiling or pasteurization.
- (iii) Food born infection may be controlled by standards of food hygiene, exclusion of sick persons from food handlings, strict attention to personnel hygiene, promotion of hand washing, protection of foods against flies and rodents and providing facilities for refrigeration.
- (iv) Safe disposal of excreta will block the transmission of disease by the faecal –oral route.

(b) **Prevention of Droplet Infection.** This can be achieved by :-

- (i) Use of mask.

- (ii) Bed spacing.
- (iii) Screening.
- (iv) Dust Control.
- (v) Avoid over-crowding.
- (vi) Proper ventilation.
- (vii) Avoid spitting in public places.
- (viii) Proper sunlight.
- (ix) Proper disinfection of air.

(c) **Prevention of Contact Disease.**

- (i) Complete segregation of patient.
- (ii) No direct personal contact between patient and the staff.
- (iii) The early diagnosis will help in preventing the spread in the patient.
- (iv) Proper disposal of all the excreta and disinfection of all articles of the patient.

(d) **Prevention of Insect Born Disease.**

- (i) Filling, leveling and drainage of breeding places and water management will help in eliminating larvae. Adequate collection, removal and disposal of sewage and waste water are important in preventing culex.
- (ii) Use kerosene oil, fuel oil, or special oil to prevent larvae.
- (iii) Use of residual sprays like malathion.
- (iv) Use of mosquito nets, screening of doors and windows, mosquito repellent and sun down sleeves.
- (v) Control the presence of rodents and fleas in and around the home.
- (vi) Avoid contact with any species of wild rodents, especially sick or dead rodents.
- (vii) Not to handle sick or dead animals or animal waste.

8. The following preventive measures are necessary to ward off these diseases;-

(a) **Segregation of the Patient.** Important points are as under:-

- (i) Preferably shift patient to an isolated room.
- (ii) Ensure room conforms to hygiene and sanitation standards ie adequate ventilation, sunlight and cleanliness.
- (iii) Nominate one healthy person to undertake nursing and care of the patient.
- (iv) Nominated person to take preventive measures like use of mask, gown, and gloves and avoid direct contact and hand washing before and after every visit.
- (v) Clothing and utensils used by patient to be cleaned / washed separately.

(vi) Safe disposal of patients excreta – Urine, Stool, Sputum, Refuse eg discarded dressings, garbage etc by burning.

(b) **Destroy Agents (Germs) Causing Infection in the Surrounding Area or Premises.** Immediately on detection of a communicable disease, the source of agents / germs causing infection should be destroyed by following actions :-

- (i) Removal / destruction of garbage.
- (ii) Cleaning the drains & keep them covered.
- (iii) Remove/ dry out waste water.
- (iv) Spray malathion mixed in water (ratio: malathion - 1 ml, water 1000 ml) in and around premises. (Caution - malathion is highly poisonous direct breathing / touch should be avoided). Wash hands after use.
- (v) Keep premises free of rodents (rats), stray dogs.
- (vi) Use mosquito nets, long sleeves, screening of doors & windows.

(c) **Disinfection.** All articles in contact with the patient should be disinfected by following means:-

(i) **Natural.** Sunlight and air can be used to disinfect articles like blanket, mattresses, pillows and also the rooms. The microorganisms thrive in darkness and need moisture for their survival, on being exposed to sunlight and air they die.

(ii) **Physical.** Physical agents like heat, cold radiation etc. can also be used for disinfection and sterilization.

(aa) **Heat.** Heat can be used in two ways for sterilizing.

(i) **Moist Heat.** Moist Heat in the form of 'boiling' kills germs very rapidly. In addition, 'autoclaving or Steam under Pressure' is the most effective method used to disinfect all hospital equipment which can be boiled like linen, bandage, dressing material, gloves and instruments.

(ii) **Dry Heat.** Dry heat like flaming or use of hot air oven. Sterilization by steam under pressure (autoclaving) is the commonest method for sterilization which is being used in the army.

(ab) **Cold.** Freezing or freeze-drying can inactivate bacteria. Some of them can however survive even at 0° C.

(ac) **Radiation.** It includes ionizing radiations like X rays, gamma beta and ultraviolet radiation. These are expensive methods and are not suitable for small-scale procedures.

(ad) **Other Methods.** Disinfection and sterilization can also be done by using other methods like of infrared rays, filtration etc.

(iii) **Chemical Agents.** Chemical agents like phenol, savlon, potassium permanganate, Hydrogen peroxide etc are commonly used for disinfection and sterilization. The strength of agent depends upon its used concentration being.

(iv) **Control of Food & Drink.** Salient points to be observed while feeding the patient:-

(aa) Clean water preferably boiled must be served to the patient Water container must be kept covered.

(ab) Balanced diet, well cooked, hygienically prepared food using less oil and condiments, should be served hot. Stale, cold and food exposed to flies & insects should not be served.

(ac) Food items sourced from restaurants / dhabas must not be served.

(v) **Inoculation and Vaccinations.** Important inoculations & vaccinations are provided free of cost under various Government programmers. These are administered at Primary Health Centers/Hospitals. If not available the same should be administered/ taken from market. Important inoculations and vaccination are as under:-

<u>Name of Vaccine</u>	<u>Disease Prevented</u>
Inj Rabipur	Rabies
Inj TAB	Typhoid
Inj Hepatitis 'B'	Hepatitis 'B'
Inj T T	Tetanus
Oral Polio	Polio

CONCLUSION

9. Communicable diseases as the name suggests are most easy to prevent if timely measures are taken as recommended above. As these diseases are communicated through some carrier or agent, their spread on occurrence is difficult to control. It is advisable to always follow the prevention measures to save precious human and animal lives national resources and effort.

LESSON PLAN : H 5
FIRST AID IN COMMON MEDICAL EMERGENCIES

Period	-	Two
Type	-	Lec/Demo/Prac
Code	-	H 5
Year	-	II (SD/SW)

Training Aids

1. Computer Slides, Pointer, Charts, Black Board and Chalk.

Time Plan

2.	(a)	Introduction	-	03 Min
	(b)	Injuries to Internal Organs	-	07 Min
	(c)	Burns and Scalds I	-	05 Min
	(d)	Snake Bite, Scorpion Bite & Rabid Dog Bite	-	15 Min
	(e)	Foreign Bodies in Eye, Ear and Nose	-	10 Min
	(f)	Asphyxia	-	15 Min
	(g)	Insensibility or Unconsciousness	-	10 Min
	(h)	Artificial Respiration	-	10 Min
	(i)	Conclusion	-	05 Min

INTRODUCTION

3 There will be number of occasions on which we may be faced with a situation where, we may be required to provide First Aid to the injured, because of an accident or due to any calamity. Therefore it is very important for all cadets to have knowledge of providing basic First Aid in common medical emergencies. In the succeeding paragraphs we will deal with certain medical emergencies and discuss about the methods First Aid to be provided.

PREVIEW

4. The class will be conducted in the following parts:-
 - (a) Part I - Injuries to Internal Organs.
 - (b) Part II - Burns and Scalds.
 - (c) Part III - Snake Bite, Scorpion Bite & Rabid Dog Bite.
 - (d) Part IV - Foreign Bodies in Eye, Ear and Nose.
 - (e) Part V - Asphyxia.

- (f) Part VI - Insensibility or Unconsciousness.
- (g) Part VII - Artificial Respiration.

PART I : INJURIES TO INTERNAL ORGANS

5. These injuries cannot be seen but can only be suspected, where bleeding instead of coming to the surface occurs into the cavity of chest or abdomen wherein, important organs like heart, lungs, liver or spleen might get ruptured. The following symptoms are observed in case of internal injuries:-

- (a) Cold clammy skin.
- (b) Weak and rapid pulse.
- (c) Shallow sighing and breathing.
- (d) Face pinched and pale.
- (e) Eyes deeply sunken with dark rings around them.
- (f) Patient usually restless and anxious and may lose consciousness.

6. **First Aid Treatment.**

- (a) Keep the patient warm and lying down with feet raised up and head kept low.
- (b) Apply cold application on the suspected injured region.
- (c) Cheer up the patient.
- (d) Arrange medical attention as soon as possible.

PART II : BURNS AND SCALDS

7. Burns may be caused by heat either, dry by contact with fire or flame, or wet, as caused by moist heat such as hot water, hot fluids and steam, which is called scalding. Chemical burns may be caused by strong acids or alkalis. .

8. **First aid Treatment.**

- (a) If the burn is chemical, let water from a pipe or hose flow freely on the burn so that the chemical flows off.
- (b) Protect the burnt area by applying bandage or cover exposed part with clean towel or cloth.
- (c) Give complete rest and plenty of fluids to the patient.
- (d) Re-assure the patient.
- (e) Give him **morphia**, if required.
- (f) Evacuate patient to the nearest hospital or dispensary.

PART III : SNAKE, SCORPION AND DOG BITE

Snake Bite

9. In Snake bite, the poison is injected by the snake through a pair of hollow and deeply grooved biting fangs. The majority of bites occur on parts of limbs which are exposed like hands, feet and lower legs.

10. **First Aid Treatment.** All cases of snake bite should be treated as being bitten by poisonous snakes. The First Aid treatment will be as follows:-

- (a) Make the victim lie down comfortably.
- (b) Give convincing reassurance against fear of death.
- (c) Apply a light constricting tourniquet with hand kerchief, bandage or shoe lace above the knee for a bite on the leg and above elbow for a bite on the arm. So that the poison does not flows to all parts of the body.
- (d) Wash with soap and water. Use water freely.
- (e) Incise into the skin 2"X ½" across the fang mark with a blade.
- (f) Suck the blood either with mouth or with a suction pump. Be careful that there is no cut out or ulcer in the mouth.
- (g) Evacuate the patient quickly to the nearest dispensary or hospital.
- (h) If breathing fails, start artificial respiration.

Scorpion Bite

11. Bite by scorpions should be treated like snake bite.

12. **First Aid Treatment.** If blood has been drawn, the wound should be cleaned well with antiseptic lotion.

Rabid Dog Bite

13. Rabies is a very dangerous disease transmitted by a rabid dog. The disease is preventable by giving anti-rabies vaccine.

14. **First Aid Treatment.**

- (a) Immediately wash the bite area with lots of water and soap.
- (b) Wound should be cleaned with available antiseptic.
- (c) Patient should be sent to hospital for an anti-rabies injection course.
- (d) Dog and the patient should be kept under observation for at least 10 days.

PART IV : FOREIGN BODIES IN EYE, EAR AND NOSE

Foreign Body in Eye

15. Particles of coal or dust may lodge on the eye-ball or inside the eye lid causing discomfort and damage to the tender structure.

16. **First Aid Treatment.**

- (a) Ask the patient not to rub the eyes.
- (b) Wash the eye with water repeatedly for a minute or two.
- (c) Search for the foreign body by lifting the upper eyelid and parting the lower eyelid down. The patient should face the light. If the foreign body is seen, it can be wiped off with the moistened corner of hand kerchief, cloth or cotton swab.
- (d) If foreign body is fixed to the eye-ball, patient should be sent to the hospital with a light eye bandage.

Foreign Body in Ear

17. This is common with children. They often put beads, peas, nuts and other objects into the ear or an insect may get into the ear.

18. **First Aid Treatment.** Do not try to remove the foreign body with the help of a pin or forceps as this may push the foreign body further in, causing damage to the ear drum. The patient should be sent to the hospital.

Foreign Body in Nose

19. This is a common occurrence among children. They might put peas, beads etc in the nostril.

20. **First Aid Treatment.**

- (a) Blowing the nose and sneezing may expel the foreign body.
- (b) Make the casualty breathe through the mouth.
- (c) Do not try to remove the foreign body.
- (d) Send the patient to the nearest hospital.

PART V : ASPHYXIA

21. The tissue and organs of the body are supplied with oxygen through respiration, essential for the functioning of body. Respiration consists of inspiration, expiration and a pause. During inspiration air is drawn inside causing the lungs to expand. During expiration the lungs contract and air is pushed out. The respiratory system consists of the air passage known as respiratory tract and lungs. The actions of muscles concerned with respiration are controlled and regulated by the respiratory centre of the brain.

Asphyxia

22. **Causes.** Anything which interferes with respiration producing irregularities in breathing, produces a condition known as Asphyxia. The **main causes** of Asphyxia are :-

- (a) Drowning – due to water entering the air passage.
- (b) Hanging and Strangulation – due to obstruction to entry of air.
- (c) **Suffocation.**
 - (i) Due to obstruction to entry of air through the air passage.

- (ii) Foreign body obstruction in air passage.
- (iii) Inhalation of poisonous gases e.g. carbon monoxide.
- (d) Over dosage of drugs such as sleeping pills, morphine, pethedine.
- (e) Electric Shock.
- (f) Diseases e.g. tetanus, epilepsy, rabies.

23. **Signs and Symptoms of Asphyxia.**

- (a) Dizziness and weakness.
- (b) Shortness of breath rate or breathing increase.
- (c) Rapid pulse.
- (d) Partial loss of consciousness.
- (e) Swelling of the veins of the neck.
- (f) Face, lips, nails, fingers and toes turn blue. ‘

24. **General Rules for Treatment of Asphyxia.**

- (a) Remove the cause if possible or the casualty from the cause.
- (b) Ensure that there is a free passage for air.
- (c) Lay the individual on his back. Press the head back-wards supporting the neck on your palm. Lift the tongue clear of the airway. Give mouth to mouth breathing.

25. **First Aid for Special Cases - Drowning.**

- (a) Wet cloths should be loosened.
- (b) Mouth, throat and nostril should be cleaned of mucus and any foreign body.
- (c) Patient should be made to lie down over his belly, face down, head turned to one side, arms stretched beyond the head, tongue pulled out.
- (d) Artificial respiration should be given till he starts breathing.
- (e) Cover the patient with a blanket.

26. **First Aid in Case of Strangulation or Hanging.**

- (a) Cut the constriction.
- (b) Clear the air passage.
- (c) Start artificial respiration.
- (d) Give inhalations if possible.
- (e) Make the patient warm and comfortable.

27. **First Aid in Case of Choking.** Bend the casualty's head and shoulders forward, to dislodge the obstructions. In case of small child hold him upside down and thump his back hard between the shoulder blades or encourage vomiting by passing two fingers to the back of the throat.

28. **First Aid in Case of Suffocation by Poisonous Gas.** Protect yourself and remove the casualty from the gas as early as possible.

29. **First Aid in Case of Electric Shocks.**

- (a) Switch off or break the current, if possible.
- (b) Remove the casualty from contact with the current, if possible. Stand on some insulating material such as rubber soled shoes or boots or piles of news papers.
- (c) Give artificial respiration.
- (d) Treat for shock and burns.

PART VI : INSENSIBILITY OR UNCONSCIOUSNESS

30. Insensibility or unconsciousness is caused due to interruption of the action of the brain, through some interference with the functions of the central nervous system.

31. **Stages of Unconsciousness.**

- (a) 1st Stage - Delirium – When the restlessness of body and mind are present.
- (b) 2nd Stage - Patient responds to loud commands, gives maximum response to minimum stimulus.
- (c) 3rd Stage - Semi- Coma- Patient responds to painful stimuli only (minimum response to maximum stimulus).
- (d) 4th Stage - When the patient makes no response to any Stimulus.

32. **Causes of Unconsciousness or Coma.**

- (a) Head injury.
- (b) Hemorrhage from brain.
- (c) Heart failure.
- (d) Diabetic coma, Hepatic coma, Uremic coma.
- (e) Excessive narcotics e.g. sleeping pills, morphine.
- (f) Intracranial or brain infections like meningitis, encephalitis.
- (g) Physical agents such as heat strokes, electric shocks.
- (h) Epilepsy.
- (i) Hysteria.

33. **General Rules of First Aid in Casualties of Unconsciousness.**

- (a) Make the patient lie down with head turned to one side. Pull out his tongue.
- (b) Loosen the clothing, ensure fresh air.
- (c) If breathing has stopped or is irregular, start artificial respiration.
- (d) Keep the air passage clear.
- (e) Nothing should be given by mouth. Remove false teeth, if any.

PART VII : ARTIFICIAL RESPIRATION

34. If there is any irregularity in breathing or a cardiac arrest, artificial respiration is given. If it is given correctly and in time, the patient's life can be saved.

35. **Types of Artificial Respiration.**

- (a) **Holger-Nielson Method.** Keep the casualty in prone position.
 - (i) **Movement 1.** Go down on the left opposite the casualty's head, placing the right foot on the ground. Place the casualty's arm carefully above his head and keep them there during the turn. Grasp his right upper arm and turn his face to one side. The mouth and nose must be unobstructed. The operator should be 6" to 12" from the top of his head. Place the hands on casualties back with the heel of the hand on the lower part of the shoulder blade, the thumb on spine and fingers pointing to casualty's feet. Keeping the arms straight rock gently forward until the arms are almost vertical, depending on the build of the casualty using no special force. The movement takes 2 seconds counting one, two. This pressure causes expiration. This is called movement 1.
 - (ii) **Movement 2.** The operator now rocks back counting 3 for one second and slides his hand and grips the upper arms near the elbow. He raises and pulls on the arms for 2 seconds counting 4, 5. He should take care not to raise the chest from the ground. This movement causes inspiration. Counting 6 the operator lowers the casualty's arm. The movements should be rhythmic in character and continued until breathing recommences. When the casualty begins to show signs of breathing the operator should continue with movement 2 only. For children the pressure on the shoulder blade should be considerably reduced or applied with fingers. The ratio should be 12 times in a minute.
- (b) **Schaefer's Method.**
 - (j) **Position of the Casualty.** Lay the casualty in prone position with hand one over other under his head, the head turned to one side, mouth and nose unobstructed.
 - (ii) **Position of the Operator.** Face the casualty's head; kneel on both knees at the side of casualty just below his hip joint. Sit back on your heels, place your hands on the loins of the casualty, one on each side of back bone with wrists almost touching, and thumbs as far forward as possible without strain, and fingers together.
 - (iii) **Movement 1.** Without bending your elbows swing slowly forward by unbending the knees until the thighs are in almost upright position, allowing the weight from your body to be communicated to the casualty's loins. This causes

abdominal organ compression against the ground and up against the diaphragm. Air is forced out of the lungs, thus expiration takes places.

(iv) **Movement 2.** Swing back slowly on to your heels, thus relaxing the pressure. This causes the abdominal organs to fall back and the diaphragm to come down thus inducing inspiration. These 2 movements must be carried out smoothly and rhythmically and should take 5 seconds (i.e. 12 times per minutes). Artificial respiration must be continued until natural breathing is restored, or unless a doctor decides that further efforts will be of no use.

(c) **Mouth to Mouth Respiration.**

- (i) Casualty should be in supine position.
- (ii) Clean the mouth and throat to maintain clear air passage.
- (iii) Extend the neck to straighten the air passage.
- (iv) Cover the patient's mouth with clean gauze and blow directly and slowly into it. (10 – 12 times per minutes).

CONCLUSION

36. First aid is a very simple and effective method which if known to an NCC cadet can save precious lives under various life threatening situations. The crucial aspects are promptness and correctness in administering first aid. A NCC cadet who reaches the victim must first quickly investigate the cause and type of injury before attempting to administer first aid.

LESSON PLAN : H 5
BASICS OF HOME NURSING

Period	-	Three
Type	-	Lec/Demo/Prac
Code	-	H 5
Year	-	III (SD/SW)

Training Aids

1. Computer Slides, Pointer, Charts, Black Board and Chalk.

Time Plan

2.	(a)	Introduction	-	05 Min
	(b)	Qualities of a Nurse	-	15 Min
	(c)	Bandage & its Application	-	15 Min
	(d)	The Sick Room Preparation	-	20 Min
	(e)	Recording of Temperature and Pulse	-	20 Min
	(f)	Feeding a Helpless Patient	-	20 Min
	(g)	Medicines and their Administration	-	20 Min
	(h)	Conclusion	-	05 Min

INTRODUCTION

3. Nursing plays a very important role in the recovery of a patient. While the doctors prescribe a course of treatment, it is the nurse who actually translates it into action. It is on the efficient nursing of the case that the whole success of the treatment depends. A large number of people have to be nursed at home either because their sickness is not severe or because on being discharged from hospital they recover at home. It is here that skill in home nursing comes in. A cadet trained in home nursing can be a great asset to a family

AIM

4. To make all the NCC cadets aware about the basics of Home Nursing.

PREVIEW

5. The class will be conducted in the following parts:-
 - (a) Part I - Qualities of a Nurse.
 - (b) Part II - Bandage & its Application.
 - (c) Part III - The Sick Room Preparation.

- (d) Part IV - Recording of Temperature and Pulse.
- (e) Part V - Feeding a Helpless Patient.
- (f) Part VI - Medicines and their Administration.

PART I : QUALITIES OF A NURSE

6. **Definition.** Home nursing can be defined as functioning of a nurse, in one's own home, taking care of the establishment and reducing the intensity and the frequency of sickness to the barest minimum. The meaning of the word-**Nurse** is:-

- N** - NOBILITY, KNOWLEDGE
- U** - USEFULNESS, UNDERSTANDING
- R** - RIGHTEOUSNESS, RESPONSIBILITY
- S** - SIMPLICITY, SYMPATHY
- E** - EFFICIENCY, EQUANIMITY

7. **Qualities of a Nurse.** A good nurse must possess the following qualities:-

- (a) **Honesty and Truthfulness.** A nurse should be honest to her profession. She should confess her mistake whenever she makes any, and not risk the life of the patient by hiding it.
- (b) **Sympathy and Understanding.** A good nurse should deal with the patient with understanding and sympathy. She should sympathetically appreciate the pain and suffering of the patient.
- (c) **Cheerfulness, Gentleness and Willingness.** A cheerful nurse reduces the sufferings of the patients to half. Her gentleness reduces their pain and discomfort. Her willingness and eagerness to help is instrumental in making them bear their troubles with a smiling face." A warm smile may be more therapeutic than a dose of medicine".
- (d) **Obedience and Discipline.** A nurse should have self discipline and should obey the orders of the doctor and carry them out without argument.
- (e) **Observant.** A Nurse should observe the minutest details of the patient's condition. If there is the slightest change in the patient's condition, she should immediately report it to the Doctor. She should also observe whether the hospital equipment is functioning properly or not.
- (f) **Tact and Sense of Humor.** A tactful nurse can deal easily with the patient who becomes irritable due to disease. Her sense of humor also helps her in bearing the hardships of her profession cheerfully.
- (g) **Courage.** To be brave or not to be afraid. He should not be afraid of any situation in professional practice.
- (h) **Team Spirit.** Spirit of team work is very essential for a nursing assistant as he is a vital link in the great chain of health work.

PART II : THE BANDAGE AND ITS APPLICATION

8. **General.** Bandages are made of various materials and are of various lengths and width according to the part on which they are to be applied. These are:-

- | | | | |
|-----|--------------------------|---|---------|
| (a) | Bandage for Finger | - | 1" wide |
| (b) | Bandage for Head and Arm | - | 2 ½ " |
| (c) | Bandage for Trunk | - | 6" |
| (d) | Bandage for Leg | - | 3 ½ " |

9. **General Rules for Application.** The rules for application of bandage are:-

- (a) Face the causality.
- (b) Hold the head of the bandage in the right hand.
- (c) Apply the outer side of the free end to the part and where possible lock it in position by a superimposed turn.
- (d) Bandage firmly from below upwards and from within outwards over the front of the limb.
- (e) Apply the layer of the bandage so that it covers neither too tight nor too loose.
- (f) When completed secure the bandage by a safety pin.

10. **Method of Application.** There are three methods of applying the roller bandages :-

- (a) **The Simple Spiral.** This is only used when the part is of uniform thickness, for example, finger or wrist. The bandage is carried out in a spiral direction.
- (b) **The Reverse Spiral.** This is used in bandaging those parts of the limbs where there is varying thickness. This is made by a number of spiral turns in which the bandage is reversed downward upon itself at each circuit of the limb.
- (c) **The Figure of 8.** It is used for bandaging in the neighborhood of a joint such as knee or elbow. This is applied by passing the bandage obliquely round the limb alternately upward and downwards.

PART III : THE SICK ROOM PREPARATION, CLEANING AND VENTILATION

11. **General.** The sick room should be that room of the house, which is away from all noise and through which there is no passage. However, it should have a bathroom and lavatory close by. It should face South or South-West.

12. **Preparation.** A sick room should not have too many things. However, it should be comfortably furnished. There should be a comfortable bed, a bed side table, two chairs and one easy chair. A cupboard for keeping equipment should also be there. A wash basin with jug of water, soap, nail brush and towel must be arranged on a stool or a small table. If possible, a curtain stand may be arranged. A waste paper basket should be kept at a convenient place.

13. **Cleaning.** Dirt and dust are depressing to a sick person and retard his recovery. Moreover, these are the biggest source of illness as they harbor germs of various diseases. Hence, due importance should be given to the daily cleaning of the room. The following points should be kept in view :-

- (a) All cleaning work should be done without disturbing the patient after the toilet is over and the bed remade.
- (b) Light furniture should be removed before the room is swept and dusted. After dusting, each piece should be wiped with a weak solution of disinfectant and then polished with dry cloth.
- (c) Dusting should be done with damp cloth. The floor should be cleaned after scattering damp tea leaves so that dust does not rise.
- (d) At night, flowers should be removed from the vases and fresh flowers arranged in the morning.

14. **Lighting.** The light should not fall direct on the face of the patient. It should come from behind or the sides. There should be a shaded lamp on the side of the patient. There should be another shaded light for the nurse, so placed, that she can do her job without disturbing the patient. A well protected light can quite serve the purpose.

15. **Ventilation.** Ventilation means the availability of pure, fresh air in abundant quantity. It also means bringing inside a house or a place of work, plenty of sunlight. This is done through doors, windows and open spaces. Fresh air is essential for human existence. One of the important processes of living is, inhalation and exhalation. The dirty air exhaled by the breathing process is replaced by clean, fresh air inhaled by nostrils. The foul breath breathed out gets mixed up with fresh air and is to be separated so that air is available for the breathing process to continue.

PART IV : TAKING / RECORDING OF PULSE AND TEMPERATURE

Pulse

16. The patient's quick recovery depends very much on the efficient routine care by the nurse. Daily routine should be planned according to the patient's habits and followed regularly unless some sudden change in the patient's condition requires some adjustment. The pulse is the heart beat and is most commonly felt at the radial on the point of the wrist. The average pulse rate is 72 beats per minute. In case of infants, it is 100 to 140 beats per minute and in case of children it is 90 to 100 beats per minute.

17. **Taking Pulse.** The rate or the pulse changes with the change in emotions and while doing exercise. To count pulse, the patient should be made to sit down in bed. The arm must be relaxed and in a prone position. To take pulse, the tips of the first three fingers should be laid down on the radial artery at the base of the palm. The index finger should be nearest to the palm of the patient's hand. The thumb should be placed at the second's hand in your watch. The result should be immediately entered in the pulse column of the TPR Chart.

Temperature

18. The normal temperature of a man is between 97 and 99 degrees F. There are slight $\frac{1}{2}$ F variations between the daily temperature in the morning and evening. The lowest temperature is between 2AM and 4AM.

19. **Measuring Temperature.** It is important to know how to measure temperature. The body temperature is taken by the clinical thermometer which is a device consisting mercury band. The

range of the thermometer is 95 F to 110 F. The degrees are indicated by black lines. A figure is written after every 5. An arrow indicates the normal level of level of temperature i.e.98.4 F.

- (a) Normal temperature by mouth is 98.4 F or 37 C.
- (b) By axilla or groin it is 1 F lower than by mouth.
- (c) By rectum, it is 1 F higher than by mouth.
- (d) Fahrenheit is changed to centigrade by the formula. $F - 32 \times \frac{5}{9} = C$.

20. **Method.** Keep the bulb of the thermometer pressed under the armpit or beneath the tongue or in the groin for 2 minutes. Take the reading and record in the Temperature column of the TPR Chart.

21. **Recording of TPR Chart.** The TPR Chart is a morning and evening record of the patient's temperature, pulse and respiration with some other details such as the number of times the patient had motions and the amount of urine passed. This helps the doctor in learning about the latest condition of the patient at one glance.

22. **Fever.** Whenever there is an inroad of disease germs in the body, due to some infection, it raises its temperature to put up a fight against the invasion. The state of more than normal temperature is called 'Fever.'

23. The normal temperature of the body is 97⁰ F to 99⁰ F. The temperature above 99⁰ causes pain, restlessness, headache and body ache. Moderate temperature from 99⁰ F to 103⁰ F is called PYearexia. High temperature from 103⁰ F to 105⁰ F is called High PYearexia. Very high temperature over 105⁰ F is called Hyper-PYearexia. Fever may be :-

- (a) **Constant.** In this the temperature remains the same all the 24 hours as in pneumonia and scarlet fever.
- (b) **Intermittent.** The temperature rises very high and falls very low. It appears when there is severe infection.

PART V : FEEDING A HELPLESS PATIENT

24. While feeding a helpless patient, the bed and the table should be properly and neatly arranged. The nurse should give full attention to the patient so that patient does not feel that he/she is being hurried through a meal.

- (a) **Feeding a Patient on Fluid Diet.** The mouth of the patient should be washed and wiped. If the patient can sit up, the fluid can be given in a cup or in a glass. If the patient wants to take fruit juice with a straw he/she should be given that. But it should be ensured that the straw is absolutely clean. If the patient cannot sit up, he/she should be fed with a feeding cup or a feeder. The bed clothes should be protected by placing a clean napkin beneath the patient's mouth. The nurse should place her left arm, under the first pillow to raise the patient's head slightly. The flow of the fluid should be regulated so that too much of it does not flow into the patient's mouth. One mouthful should be done with a tea spoon also. In case of jaw injuries, a small rubber tube is attached to the spout of the feeding cup and then put between the teeth. The patient should be given small quantity to swallow at one time. After feeding the patient, lips should be wiped with a clean towel.
- (b) **Feeding with Solid Food.** Food should be served in an attractive manner arranged attractively on a side table. One dish should be brought at one time. The food should be served hot. It should be put in a plate in the kitchen before bringing to the

patient. Patient should be fed with a spoon. As soon as food is finished the plate should be removed.

PART VI : MEDICINES AND THEIR ADMINISTRATION

25. A Nurse has to take great care with medicines. She should fully understand the doctor's prescription and keep the medicines well labeled and properly stored. There should be three separate shelves of a cupboard, one for lotion, one for medicines and the third one for poisons.

26. **Administering Medicines.** Proper administration of medicines is most important, as on it depends, the very life of the patient. Hence, if there be any doubt the doctor should be asked to clear it. The following points should be kept in mind while giving medicines:-

(a) **While Giving Liquid Medicines.**

(i) Check the label with the prescription. If handling a new medicine read the instructions carefully. Shake the medicine well.

(ii) Put your thumb near the correct marking of dosage on the medicine glass. Hold the glass in level with the medicine bottle. Pour away from the label so that it does not become illegible. Replace the cork immediately.

(iii) Read the instructions once again before actually giving the medicine to the patient.

(iv) Take the medicine on a tray with a glass of water and spoon in case the medicine requires stiffing. If the medicine has a bitter taste, give the patient some sweet drink.

(v) Never pour back any unused medicine, throw it away.

(b) **Other Medicines.**

(i) In case of pills, tablets, capsules and powder, remember that a pill has a sugar coating and a capsule has a gelatin coating and hence can be easily swallowed with water. Tablets if not swallowed by the patient may be crushed and put on the back of the tongue for swallowing. Powder must be poured at the back of the patient's tongue and water poured in his mouth.

(ii) Iron mixture should be given with straws so that the teeth are not stained. If the patient is not too weak, he/she should be asked to clean his/her teeth.

CONCLUSION

27. Home nursing is a common household practice prevalent in the society. NCC cadets can be of tremendous assistance at their homes or neighborhood whenever such the need arises for extending assistance to our relations and friends during sickness or injury. Knowledge of this subject is essential for cadets to be of assistance to other cadets during camps and adventure activities as also to victims during disaster management.

LESSON PLAN : H 6
TREATMENT AND CARE OF WOUNDS

Period	-	One
Type	-	L/P
Code	-	H 6
Year	-	II (SD/SW)

Training Aids

1. Computer Slides, Charts, Pointer, Black Board and Chalk.

Time Plan

2.
 - (a) Introduction - 03 Min
 - (b) Classification of Wounds - 10 Min
 - (c) First Aid for Wounds - 10 Min
 - (d) Dressing of Wounds - 15 Min
 - (d) Conclusion - 02 Min

INTRODUCTION

3. In our daily life, we do suffer from various types of wounds. Proper treatment and care of wounds is extremely important for a healthy life, especially in children because, if some wounds are not treated properly, they may cause serious diseases like gangrene or tetanus.

AIM

4. To teach the NCC cadets about the Treatment and Care of Wounds.

PREVIEW

5. The class will be conducted in the following parts:-
 - (a) Part I - Classification of Wounds.
 - (b) Part II - First Aid for Wounds.
 - (c) Part III - Dressing of Wounds.

PART I : CLASSIFICATION OF WOUNDS

6. **Definition.** Wounds can be defined as a break in continuity of the skin or muscles membrane. It is caused by violence.
7. **Classification.** Wounds can be classified as under:-
 - (a) **Inside Wound.** It is wound caused by a sharp instrument like knife, razor and so on. Its edges are clean.
 - (b) **Lacerated Wound.** It is caused by blunt instrument. The edges are torn or uneven.

(c) **Punctured Wound.** It is a deep narrow wound caused by a pointed instrument like knife, bayonet. The wound is small on the surface but may be very deep causing injuries to internal organs.

(f) **Contusion.** A contusion is an injury or a bruise in which some of the tissues or a part is irregularly torn or ruptured but, the skin may not be broken. It is caused by a blow or blunt instrument.

PART II : FIRST AID FOR WOUNDS

8. The method for giving first aid for different types of wounds are:-
- (a) Place the patient in a comfortable position.
 - (b) Stop the bleeding, if any.
 - (c) Remove any foreign body, if it is easily visible and can be easily removed.
 - (d) Prevent the entry of germs by applying sterilized dressing like first field or shell dressing.
 - (e) Give rest to the injured part by sling.
 - (f) Immobilize the part, if wound is large or complicated by fracture.
 - (g) Treat the patient for shock.
 - (h) Send the patient to nearest hospital.

PART III : DRESSING OF WOUNDS

9. A wound is to be cleaned with antiseptic lotion and covered with cotton or gauze piece with medication, before applying the bandage.

10. **Aim.** The aim of dressing a wound is as under:-

- (a) To protect the wound from infection.
- (b) To reduce swelling and early healing.
- (c) To support the effected part.
- (d) To enable the individual to carry out his day to day routine.
- (e) To stop the bleeding.

11. **Articles Required for Dressing of Wounds.**

- (a) Anti septic (A/S) lotion.
- (b) Cotton / Gauze piece.
- (c) Scissors.
- (d) Bandages of different size and band aid.
- (e) A/S ointment or powder.

12. **Procedure for Dressing of Wounds.** The following procedure is to be adopted while dressing of wounds:-

- (a) Reassure the patient and place him in comfortable position.
- (b) Stop the bleeding, remove foreign body and clean the wound with A/S lotion and cotton.

- (c) Apply A/S ointment or powder and cover it with gauze. Select suitable bandage, Start bandaging clock wise from outer aspect to inner aspect by covering 1/3 of previous lining.
- (d) Put the knot away from the wound.
- (e) Bandaging should not be either too tight or loose.

CONCLUSION

13. Wounds are a common feature among humans who are outdoor oriented. If cared properly during early stage the wounds heal quickly. Resultantly the wounded person suffers less and is available to the society as a healthy and fit person to resume work. NCC cadets by virtue of their routine are prone to injuries and hence must possess this basic knowledge to help fellow cadets or friends in school or at home.

LESSON PLAN : H 6
TREATMENT AND CARE OF FRACTURES

Period	-	One
Type	-	L/P
Code	-	H 6
Year	-	III (SD/SW)

Training Aids

1. Computer Slides, Charts, Pointer, Black Board and Chalk.

Time Plan

2.	(a)	Introduction	-	03 Min
	(b)	Causes, Classifications and Symptoms of Fractures	-	10 Min
	(c)	First Aid for Different Fractures	-	15 Min
	(d)	Dislocation, Sprain and Strain	-	10 Min
	(e)	Conclusion	-	02 Min

INTRODUCTION

3. In our daily life, we do suffer from various types of fractures. Proper treatment and care of fractures is extremely important for a healthy life, especially in children because, if some fractures are not treated properly, they may cause serious deformity or diseases like gangrene leading to amputation of the affected limb.

AIM

4. To teach the NCC cadets about the Treatment and Care of various types of Fractures.

PREVIEW

5. The class will be conducted in the following parts:-
 - (a) Part I - Fractures – Causes, Classifications and Symptoms.
 - (b) Part II - First Aid for Different Fractures.
 - (c) Part III - Dislocation, Sprain and Strain.

PART I : FRACTURES AND THEIR CAUSES

6. **Definition.** A **Fracture** is defined as a discontinuity or break in a bone, resulting in the dissolution of the supporting frame work of the body.
7. **Causes of Fracture.** Fractures can be caused due to the following:-
 - (a) **Through Direct Violence.** The bone breaks on the spot where direct violence is applied by a kick, bullet, blow etc.

(b) **Through Indirect Violence.** The bone breaks at some distant place from the spot of violence i.e. fracture of clavicle, base of skull etc, when the force is on out stretched hands or other extremities.

(c) **Through Forcible Muscular Contraction.** Fracture of patella (knee cap) by contraction of thigh muscle. Fracture of ribs may be caused by violent coughing.

(d) **Diseases of Bones.** Certain diseases of bones make them weak and easily breakable.

6. **Classifications of Fractures.** A fracture can be classified into the following three types:-

(a) **Simple or Closed.** In this type, the broken bones are covered with skin and there is no open wound.

(b) **Compound or Open.** In this type, the skin covering the fracture is broken or ruptured and sometimes the broken piece may protrude through it.

(c) **Complicated.** The broken bone damages the under lying structure like blood vessels nerves, lungs, brain etc.

7. **Symptoms & Signs of Fractures.** The visible signs and symptoms of fracture are:-

(a) Pain, swelling and tenderness over the fractured part and around it.

(b) Loss of power.

(c) Abnormal mobility.

(d) Deformity and irregularity of bones.

(e) Grating sound due to broken bones.

PART II : FIRST AID FOR DIFFERENT TYPE OF FRACTURES

First Aid

8. **In Case of Simple Fracture.** The first aid to be rendered is:-

(a) Reassure the patient and make him comfortable.

(b) Apply splints with any common article like stick or ply board or card board to immobilize the fracture.

(c) Relieve him of discomfort and pain and keep the patient warm.

9. **In Case of Compound Fracture.** The first aid to be rendered is:-

(a) Bleeding should be stopped immediately.

(b) Remove foreign objects, if any, but do not meddle too much.

(c) Cover the wound with a clean pad with light bandage.

(d) Apply appropriate splints.

(e) Transfer the patient to the nearest hospital immediately.

Treatment of Fractures

10. **Fracture of the Jaw Bone.**

(a) Apply Barrel Bandage.

- (b) Warn the patient not to speak.
 - (c) Instruct the patient to sit.
 - (d) In lying cases, place patient on his chest, his head projecting outside the stretcher canvas, properly supported with bandages secured on stretcher handle.
11. **Fracture of the Clavicle.** In fracture of the clavicle we need to:-
- (a) Support the arm of injured side by passing a narrow folded bandage under the arm pit and tying it on the back of the shoulder.
 - (b) Put a pad in arm pit, apply greater arm sling and fix the arm with a narrow fold bandage tied across the elbow to lower chest.
12. **Fracture of the Ribs.** When ribs are fractured following action is taken:-
- (a) **Uncomplicated.** Restrict the movement of chest on fracture side, with broad-fold bandage, one above and one below the fracture side, half overlapping each other. Support the arm of injured side with greater arm sling.
 - (b) **Complicated.** Put the patient on the affected side and support the position by long fold blankets. Send the patient immediately to the nearest hospital.
13. **Fracture of the Shoulder Blade and the Upper Limb.** Fix the elbow to the affected side and put the finger in a position touching the opposite shoulder. Secure the hand in position by cuff sling. Secure the limb firmly to the chest by two broad bandages one on shoulder and the other at the elbow level and knot on opposite side.
14. **Fracture of the Lower Limb.**
- (a) Fix the injured limb to the sound limb with four narrow folds.
 - (b) Apply long wooden splint from axilla to just beyond the foot on each side. Secure them by seven broad folds bandages tied at chest, pelvis, ankles, both thighs below the fracture, both legs, and knees.
 - (c) In case of fracture of the pelvis, apply Thomas splint if available, otherwise the methods described in (a) and (b) should be used for immobilization of lower limb before evacuation of injured person to the nearest hospital.
15. **Fracture of the Spine.** Fractures of spine are to be very carefully handled. We have to:-
- (a) Treat any case of back injury as a fracture of the spine. There will be severe pain and shock in all cases.
 - (b) Make the patient still. Do not allow the patient to move about.
 - (c) If unconscious see that the tongue does not fall back and choke the patient.
 - (d) Get medical aid at the earliest.
 - (e) Apply broad bandages for thigh and knees.
 - (f) Carry the patient face downwards on a board placed lengthwise on the stretcher.

16. **Fracture of the Skull.** It may injure the brain, nervous system or the arteries and cause concussion and compression. It may be caused by direct or indirect blow.

- (a) **If Breathing is Normal.** Lay the casualty on back with shoulders and head raised with cushions. Turn the head to one side.
- (b) **If Breathing is Abnormal.** Lay the casualty in a three quarter prone position. Apply pads under the chest and draw up the upper knee.
- (c) Do not give anything to drink.
- (d) Do not disturb the patient.
- (e) Keep air passage clear.
- (f) Treat for shock.

PART III : DISLOCATION, SPRAIN & STRAIN

17. **Dislocation.** Dislocation means displacement of one or more bones at a joint. The joints which are more frequently dislocated are the shoulder, elbow, lower jaw, thumb and the fingers.

- (a) **Signs and Symptoms of Dislocation.**
 - (i) Severe pain at or near the joint.
 - (ii) Fixity of the joint or loss of power.
 - (iii) Deformity of joint and un-natural position of the limb.
 - (iv) Swelling at the joint.
- (b) **First Aid in Dislocation.**
 - (i) Do not try to reduce the dislocation.
 - (ii) Tie sling or bandage to immobilize the joint, apply cold compress to reduce the swelling.
 - (iii) Send the patient to the nearest hospital for early treatment.

18. **Sprain.** A Sprain is the wrenching of the ligaments and tissues around the joint.

- (a) **Signs and Symptoms of Sprain.**
 - (i) Pain at the joint.
 - (ii) Inability to use the joint.
 - (iii) Swelling and later bruising.
- (b) **First Aid for Sprain.** Place the joint in a comfortable position and apply a firm bandage. Prevent movements. Keep the bandage wet with cold water to avoid swelling. Later gently massage over the muscle and apply a crepe bandage. Analgesics should be given. Whenever you are in doubt whether an injury is a sprain or dislocation or fracture, treat it as a fracture.

19. **Strains.** A strain is the over stretching of a muscle.

- (a) **Signs and Symptoms of Strain.**
 - (i) There is sudden sharp pain.

- (ii) There may be swelling or severe cramp.
- (iii) Further exertion is difficult or impossible.

(b) **First Aid for Strain.** Place the patient in the most comfortable position. Support the injured part. Give cold compress.

20. **Crepe Bandage.** A crepe bandage is made of elastic material which stretches and binds firmly around the joint to which it is applied. It thus helps in reducing swelling and movements at the affected joint, thereby minimizing pain and giving it rest. It is used in sprains and strains around joints. It can be washed and used again.

CONCLUSION

21. It is essential for all human beings to take proper precautions whenever they hurt themselves. Injuries can result in different kinds of fractures; the cadets should also be trained to treat various type of fractures to avoid complications at later stages.

LESSON PLAN : H 7
INTRODUCTION TO YOGA AND EXERCISES

Period	-	Two
Type	-	Lec/Demo/Prac
Code	-	H 7
Year	-	III (SD/SW)

Training Aids

1. Computer Slides, Charts, Pointer, Black Board and Chalk.

Time Plan

2.	(a)	Introduction	-	05 Min
	(b)	Historical Perspective and Purpose of Yoga	-	10 Min
	(c)	Potential Benefits of Yoga for Adults	-	10 Min
	(d)	Potential Problems	-	10 Min
	(e)	Asanas	-	40 Min
	(f)	Conclusion	-	05 Min

INTRODUCTION

3. Yoga is a commonly known activity for physical, mental, and spiritual disciplines which originated in ancient India. Yoga is one of the six orthodox schools of Hindu philosophy. One of the most detailed and thorough expositions on the subject are the Yoga Sutras of Patanjali. Various traditions of yoga are found in Hinduism, Buddhism, Jainism and Sikhism.

AIM

4. To teach the NCC cadets the practice of Yoga exercises.

PREVIEW

5. The class will be conducted in the following parts:-
 - (a) Part I - Historical Perspective and Purpose of Yoga.
 - (b) Part II - Potential Benefits of Yoga for Adults.
 - (c) Part III - Potential Problems.
 - (b) Part IV - Asanas.

**PART I : HISTORICAL PERSPECTIVE AND
PURPOSE OF YOGA**

6. Pre-philosophical speculations and diverse ascetic practices of first millennium BC were systematized into a formal philosophy in early centuries AD by the Yoga Sutras of Patanjali. By the

turn of the first millennium, Hatha Yoga emerged as a prominent tradition of yoga distinct from the Patanjali's Yoga Sutras. While the Yoga Sutras focus on discipline of the mind, Hatha yoga concentrates on health and purity of the body.

7. Hindu monks, beginning with Swami Vivekananda, brought yoga to the West in the late 19th century. In the 1980s, yoga became popular as a physical system of health exercises across the Western world. Many studies have tried to determine the effectiveness of yoga as a complementary intervention for cancer, schizophrenia, asthma and heart patients..

Definition

8. The Sanskrit word yoga which is "yoke", "to join", "to unite", or "to attach" from the root yuj, already had a much more figurative sense, where the yoking or harnessing of oxen or horses takes on broader meanings such as "employment, use, application, performance" , "to put something to some use". In Hindu philosophy, the word yoga is used to refer to one of the six orthodox (āstika) schools of Hindu philosophy.

Purpose

9. Generally put, yoga is a disciplined method utilized for attaining a goal. In this sense, the purpose of yoga depends on the philosophical or theological system with which it is conjugated. In Shaiva theology, yoga is used to unite Kundalini with Shiva. Mahabharata defines the purpose of yoga as the experience of Brahman or Ātman pervading all things. In contemporary times, the physical postures of yoga are used to alleviate health problems, reduce stress and make the spine supple. Yoga is also used as a complete exercise program and physical therapy routine.

PART II : POTENTIAL BENEFITS OF YOGA FOR ADULTS

10. Yoga as Exercise or Alternative Medicine.

(a) Many yoga practitioners have reported musculoskeletal and mental health improvements, as well as reduced symptoms of asthma in asthmatics. Regular yoga practice increases brain GABA levels and has been shown to improve mood and anxiety more than some other metabolically matched exercises, such as walking.

(b) The three main focuses of Hatha yoga (exercise, breathing, and meditation) make it beneficial to those suffering from heart disease. Overall, studies of the effects of yoga on heart disease suggest that yoga may reduce high blood pressure, improve symptoms of heart failure, enhance cardiac rehabilitation, and lower cardiovascular risk factors.

(c) For chronic low back pain, specialist Yoga for Healthy Lower Backs has been found 30% more beneficial.

(d) There has been an emergence of studies investigating yoga as a complementary intervention for cancer patients. Yoga is used for treatment of cancer patients to decrease depression, insomnia, pain, and fatigue and increase anxiety control.

(e) **Mindfulness Based Stress Reduction (MBSR)**. This program includes yoga as a mind-body technique to reduce stress. A study found that after seven weeks the group treated with yoga reported significantly less mood disturbance and reduced stress compared to the control group. Another study found that MBSR had showed positive effects on sleep anxiety, quality of life, and spiritual growth.

(f) Yoga has also been studied as a treatment for schizophrenia. Yoga is found to improve cognitive functions and reduce stress in schizophrenia, a condition associated with cognitive deficits and stress-related relapse.

(g) The practice of yoga in Hindu tradition also has psychological benefits, allowing one to develop control over one's mind and body. Rather than adapting the sick or mentally ill mind (which is also the primary focus of modern psychology), traditional Hindu psychology focuses on enhancing the normal and healthy mind through the practice of meditative techniques such as yoga.

(h) Implementation of the Kundalini Yoga Lifestyle has shown to help substance abuse addicts increase their quality of life according to psychological questionnaires like the Behavior and Symptom Identification Scale and the Quality of Recovery Index.

PART III : POTENTIAL PROBLEMS

11. Certain health problems associated with yoga have been brought to the attention of the general public. Yoga has been criticised for being potentially dangerous and being a cause for a range of serious medical conditions including thoracic outlet syndrome, degenerative arthritis of the cervical spine, spinal injuries, retinal tears, damage to the common fibular nerve, knee injuries, and headaches are common ailments which may result from yoga practice.

12. Some yoga practitioners do not recommend certain yoga exercises for women during menstruation, for pregnant women, or for nursing mothers. However, mediation and breathing exercises are encouraged.

13. The main reasons that experts cite for causing negative effects from yoga, beginners' competitiveness and instructors' lack of qualification are foremost. As the demand for yoga classes grows, many people get trained and certified to become yoga instructors. However, not every newly certified instructor can evaluate the condition of every new trainee in their class and recommend refraining from doing certain poses to avoid injuries. In turn, a beginning yoga student can overestimate the abilities of their body and strive to do advanced poses before their body is flexible enough to perform them.

Children and Yoga

14. Research in the countries which have advanced medical research and development facilities do not recommend , Yoga exercises for children under 16 because their bodies' nervous and glandular systems are still growing, and the effect of Yoga exercises on these systems may interfere with natural growth. However, meditation and simple breathing exercises (without breath-holding) are safe and can help children to manage stress, impulsiveness, and emotional situations.

PART IV : ASANAS

15. There are innumerable asanas. Some of the asanas useful for curing ailments and maintain good health are as follows:-

(a) **Padmasana**. Sit on the asan. Spread the legs forward, place your left foot on the join of your right thigh, and right foot on the joint of left thigh in such a way that both heels touch each other below your navel in the middle of abdomen. Place your hands on your knees. Keep the head and spinal column erect. Keep your eyes close or open. Stay in the final position for 1-2 minutes in the initial stage. Later increase the time gradually. This asan is useful for Jaap, Dhyana and Samadhi. This asan also helps in curing diseases like asthma, hysteria and insomnia.

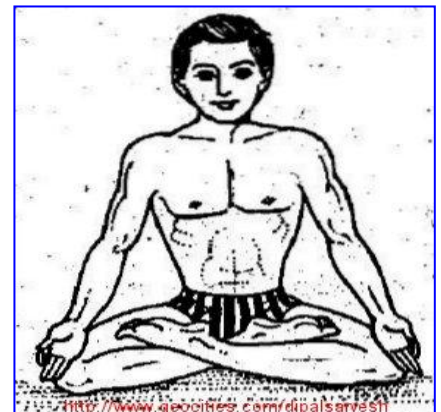

(b) **Baddha Padmasana**. Sit in Padmasana. Try to project the feet as far as possible. Take the hand behind your back. Catch the right toes with your right hand and left toe with your left hand. Keep the back bone straight and fix your eyes on the tip of the nose. This asana improves nervous system and the abdomen. It also cures drowsiness, sleepiness, laziness and night discharge.

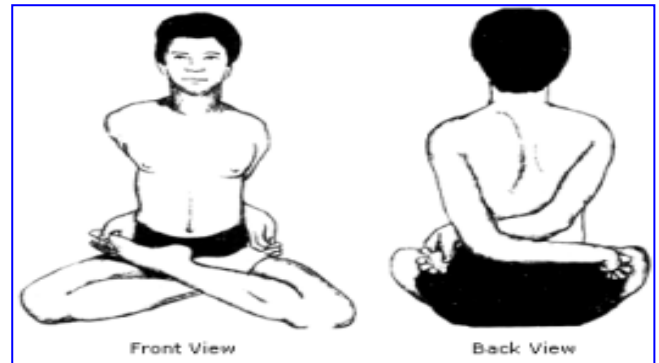

(c) **Siddhasana**. The main function of this asana is to awaken the power of Kundalini. Sit on the carpet. Place the heel of left foot under the testis on the prostate gland in such a way, that the sole of your foot should be placed at root of genitals. Place the hand on the knees so that palm face upward. This asana helps the mind to be firm, attentive and alert.

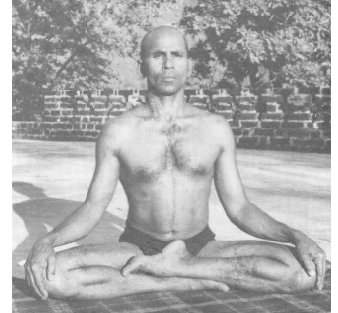

(d) **Gyan Mudra**. Sit in Padmasana or siddhasana. Put your Hands on your knees with palm facing upwards. Bend your index finger and place them at the root of your thumbs. Spread the remaining three fingers forward, all joined together. This asana is most suitable for pranayam and dhyana.



(e) **Trikonasana**. Stand erect keeping the distance between the feet 60 – 75 cm. Raise your right hand towards the sky and look towards its palm. Then bend the trunk to the left side and try to touch left toe with the left hand without bending your legs. Repeat this process with your left hand up and right hand down. This asana is useful to the eyes, spinal cord, neck and mental power. Timings 3 – 6 sec. 4 – 6 times.

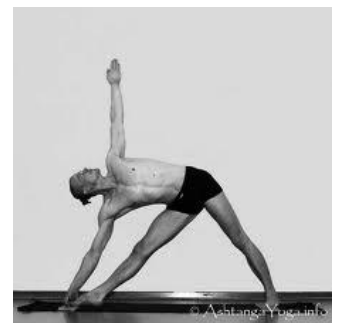

(f) **Ardha Chandrasana**. Stand erect. Raise your both hands and join them above your head. Bend towards left from the waist. After some time bring they body back in straight position. Repeat this by bending the body towards right. This asana improves the functioning of heart, liver, intestine, stomach, lungs and make the body flexible. Timing 4 - 6 sec, 4 - 5 times.



(g) **Suryanamaskara.** Suryanamaskara is a combined sequence of 12 positions. By this sequence of 12 positions, the whole body is well exercised. While practicing Suryanamaskara recite the different names of Sun god at each position.

Stage 1:- Stand in attention. Fold your hands in the centre of your chest. Now recite the first of the twelve mantras.

Stage 2:- Stretch your hands up and take the body backwards from the waist as far as possible. The hands must remain straight and touch your ears.

Stage 3:- Now bend down without bending the knees. Try to put the palms on the ground and touch the nose with knees without bending knees.

Stage 4:- Take left leg back. Bend your right knee, the knee will remain between the two arms, with the hands sticking to the ground, Now bend the neck backward as far as possible. Look forward and hold the breath.

State 5:- Take right leg back. Put both the toes and the knees together and pull your body up in such a way that it looks like inverted 'V'. Look backward through your legs keeping the head, the waist and the arms in a straight line.

State 6:- Bend down your body in such a way that your forehead, chest and knees should touch the ground except your hips which should be slightly raised from the ground.

State 7:- Stretch the arms, Inhale, put the chest forward and move back your neck as much as you can. Look up and hold the breath.

State 8:- Maintain same position as in Stage 5.

Stage 9:- Maintain same position as in Stage 4.

Stage 10:- Maintain same position as in Stage 3.

Stage 11:- Maintain same position as in stage 2.

Stage 12:- Maintain same position as in Stage 1 and then take your hand down. Make the rest posture.

(h) **Shavasana.** The main aim of this asana is releasing the mind from the body. By this asana we can achieve relaxation in the shortest possible time. This asana provides relief in disease like blood pressure, weakness of nerves and other ailments. Lie on your back and let your body be relaxed completely. Your feet should be 30-45 cm apart, arms in sides with palm upwards, eyes gently closed with attention on breathing. Keep body in a straight position. For proper blood circulation in the body, the legs, hand and neck should have no curves or



bend. Take a long and deep breath then concentrate on each and every part of your body, putting it in a relaxed state Timing 5-10 minutes.

(j) **Gomukhasana**. Sit on the seat comfortably. Place your left foot heel under your left hip. Now take the right leg over the left buttock in such a manner that the heel of your right foot is placed near your left hip. Take right arm behind back from above and left arm from below, so that fingers of the both hands are interlocked behind the back. Stay in this position for some time. Then repeat this with opposite side. Timings 20-30 seconds, 4-6 times.

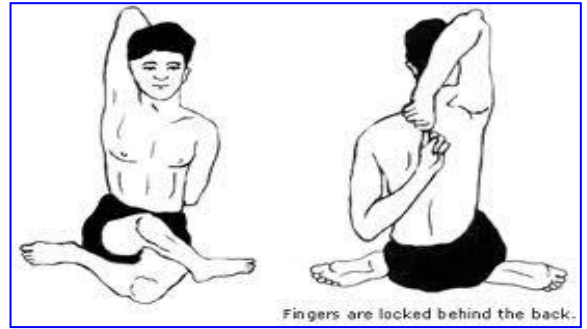

(k) **Vijrasana**. Bend the legs and sit on knees. Place the heels at the sides of the anus in such a way that thighs rest on the legs and the buttock rest on the heels. Stretch the arms and place the hands on the knees. Keep the knees close by. Sit erect. This asana can be done immediately after eating food. This helps digestion and eliminates gas troubles. Timing 1-3 minutes.

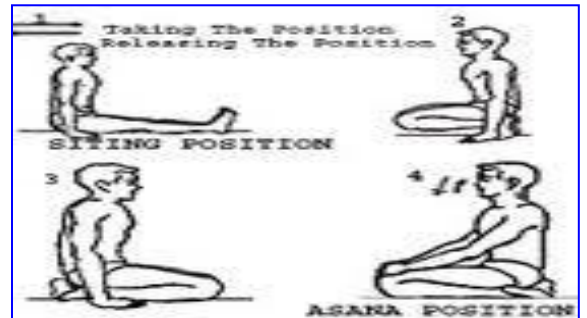

(l) **Dhanurasana**. Lie down on the chest, legs should be folded at the knees and the feet should be grasped with both the hands near the ankles. The thighs and the chest should be raised, making the body appear like a bow. This asana provides good exercise to the abdominal muscles, lower back and thighs, Timing 10-30 seconds, 4-5 times.

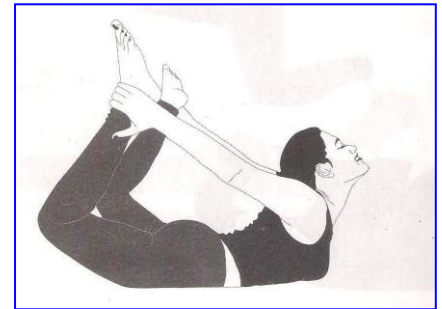

(m) **Bhujangasana**. Lie down on the chest. The hands should be below the shoulders with the fingers pointing forward. The legs are kept straight with the feet touching each other and the soles facing up. Raise the head, giving a backward bend to the spine. Try to keep the spine bent backward as much as possible without raising the navel. This asana is good for the spine, the chest, the neck and the head. Timing 20-30 sec. 4-6 times.



(n) **Chakrasana**. Lie down on the back. Bend the legs at the knees. Heels are close to the hips and sole touching the ground. Bend the arms at the elbows and place them on the ground on either side of the head. Place them in such a way that palms should rest on the ground and the direction of the fingers should be towards your feet. First raise your hips and waist, keeping the legs straight. Raise the back as far as possible. This asana helps in making the spine supple. Timing ½ -1 min, 1-2 times.

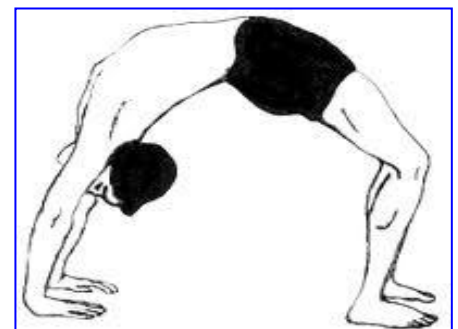

(o) **Sarvangasana.** Lie down flat on the back. Raise legs from the hips, push the trunk up until legs are in vertical position. The chin should press against the chest. The hands are giving support to lower ribs. Hold this position upto 2-10 minutes. Come back as slowly as possible. Do not give any jerks to the body. This asana improves circulatory, respiratory and alimentary systems of the body. Timings: ½ -1 minute.

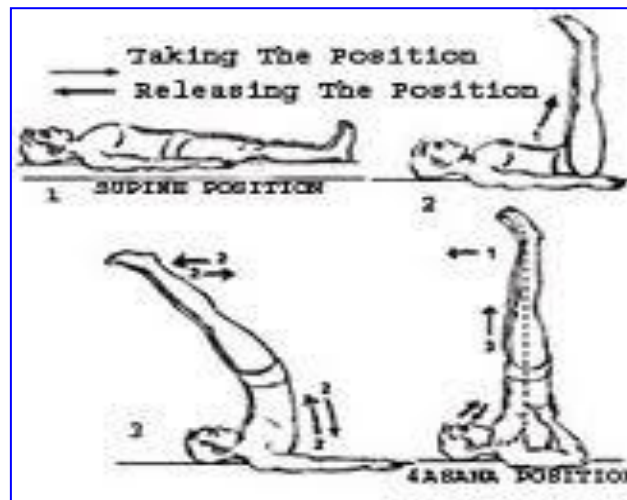

(p) **Halasana.** Lie down flat on the back. Place the arms by sides along the hips, palm facing the ground. The legs are raised up in a single motion and put down behind the head keeping knees unbent. The chin should touch the chest. In this exercise, the legs will remain straight and breathing should be normal. Hold this position for 30-50 seconds. This asana stimulates blood circulation and makes the spine flexible and elastic.

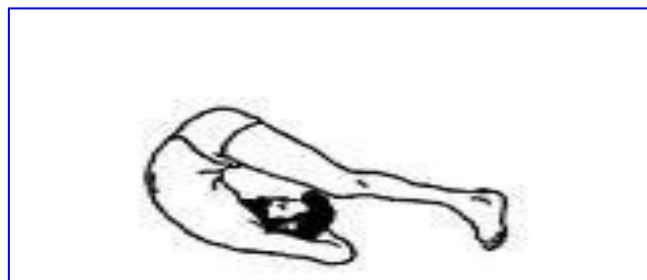

CONCLUSION

16. Yoga is a time tested, well researched, form of exercise having deep religious and medical overtones. The deep and positive effects of yoga on the body and mind of a practitioner can be felt better by doing it under a trained teacher. Once a person initiates himself into the medico-spiritual world of yoga, it is difficult for him to detach himself from it.

INDEX**ENVIRONMENT AWARENESS & CONSERVATION**

<u>Ser No</u>	<u>Lesson Code</u>	<u>Subject</u>	<u>Cat</u>	<u>Page No</u>
1.	E 1	Natural Resources - Conservation and Management	SD /SW	262
2.	E 2	Water Conservation and Rain Water Harvesting	SD /SW	266
3.	E 3	Waste Management	SD /SW	270
4.	E 4	Pollution Control - Water, Air, Noise and Soil	SD /SW	273
5.	E 5	Energy Conservation	SD /SW	277
6.	E 6	Wildlife Conservation & Projects in India	SD /SW	280

LESSON PLAN: E 1
NATURAL RESOURCES CONSERVATION & MANAGEMENT

Period	-	One
Type	-	Lecture
Code	-	E 1
Term	-	I (SD/SW)

Training Aids

1. Computer, Projector, Charts, Pointer, Black Board & Chalk

Time Plan

2. (a) Introduction - 05 Mins
- (b) Type of Natural Resources - 15 Mins
- (c) Conservation and Management of Resources - 15 Mins
- (d) Conclusion - 05 Mins

INTRODUCTION

3. A **natural resource** is any useful product which is produced by nature and is essential for our survival. Natural resources can be classified in different ways as per their nature or availability or type. A few examples of natural resources are air, water, wood, oil, solar energy, wind energy, fossil fuels, minerals and coal. Refined oil is not a natural resource since humans create it.

AIM

4. To acquaint the cadets about Natural resources, their conservation and Management.

PREVIEW

5. The lecture will be conducted in following parts:-
 - (a) Part I - Type of Natural Resources.
 - (b) Part II - Conservation and management of Natural Resources.

PART I : TYPES OF NATURAL RESOURCES

6. Natural resources can be classified by various methods, which include source of origin, stage of development and by their renewability. These classifications are described below.
7. Natural resources are basically classified as either renewable or non-renewable:-
 - (a) **Renewable Resources**. These are resources which can be replenished naturally. Some of these resources, like sunlight, air, wind, water etc, are continuously available and their quantity is not noticeably affected by human consumption.

(b) **Non-Renewable Resources.** These are resources which are formed extremely slowly and those which do not naturally form in the environment. Minerals and Fossil Fuels are the most common resources included in this category.

8. Resources can be further classified on the basis of origin as under :-

(a) **Biotic.** Biotic resources are obtained from the biosphere (living and organic material), such as forests and animals and the materials that can be obtained from them. Fossil fuels such as coal and petroleum are also included in this category because they are formed from decayed organic matter.

(b) **Abiotic.** Abiotic resources are those that come from non-living, non-organic material. Examples of abiotic resources include land, fresh water, air and heavy metals including ores such as gold, iron, copper, silver, etc.

9. Considering their stage of development, natural resources may be referred to in the following ways:

(a) **Potential Resources.** Potential resources are those that exist in a region and may be used in the future. For example, petroleum may exist in many parts of India, having sedimentary rocks but until the time it is actually drilled out and put into use, it remains a potential resource.

(b) **Actual Resources.** Actual resources are those that have been surveyed, their quantity and quality determined and are being used in present times. The development of an actual resource, such as wood processing depends upon the technology available and the cost involved.

(c) **Reserve Resources.** The part of an actual resource which can be developed profitably in the future is called a reserve resource.

(d) **Stock Resources.** Stock resources are those that have been surveyed but cannot be used by organisms due to lack of technology. For example, hydrogen.

PART II : CONSERVATION AND MANAGEMENT OF NATURAL RESOURCES

Need for Management and Conservation of Natural Resources

10. Most of natural resources on earth, especially the non renewable resources, have a finite limit. Excessive use of these may deprive the future generations their use. It is therefore extremely essential that we not only conserve natural resources but also plan their proper management so that the longevity of these resources increases. Some of the major effects of unrestricted use of natural resources are as under :-

(a) **Ozone Depletion.** This is a process by which the total volume of ozone in the Earth's atmosphere decreases. The major reason for this ozone layer depletion is the production of man-made refrigerants (CFCs, Freon, Halons). Since the ozone layer prevents most harmful UVB wavelengths (280–315 nm) of ultraviolet light (UV light) from passing through the Earth's atmosphere, depletion of the ozone layer has serious damaging effects.

(b) **Soil Erosion.** Erosion is the process by which soil and rock are removed from the Earth's surface by natural processes such as, wind or water flow and then transported and deposited at other locations. While erosion is a natural process, human activities such as deforestation and expansion of built up areas have dramatically increased the rate at of soil erosion. Excessive soil erosion causes problems such as desertification, decreases in agricultural productivity due to land degradation, sedimentation of waterways and ecological collapse due to loss of the nutrient rich upper soil layers.

(c) **Acid Rain.** It is a rain or any other form of precipitation that is unusually acidic, meaning that, it possesses added levels of hydrogen. Acid rain is caused by emissions of harmful chemicals such as sulfur dioxide and nitrogen oxide, which react with the water molecules in the atmosphere to produce acids. Chemicals in the acid rain cause paint to peel, corrosion of steel structures such as bridges and erosion of stone statues, besides causing total destruction to crop.

(d) **Global Warming.** Global warming is a phenomenon associated with the increase of earth's temperature. One of the major causes of global warming has been excessive production of Greenhouse gases. A greenhouse gas is a gas that absorbs and emits radiation within the thermal infrared range. The primary greenhouse gases in the Earth's atmosphere are water vapour, carbon dioxide, methane, nitrous oxide and ozone. Green house gases have a great affect on the earth's temperature.

Methods of Management and Conservation of Natural Resources

11. Following methods contribute immensely towards efficient conservation of resources :-

(a) **Recycling.** This is a method by which some of the resources can be conserved by recycling them or reusing them by adopting certain methods as under:-

(i) Recycling of paper will reduce the burden on trees.

(ii) Recycling of water including sewage will reduce the burden on sub soil / fresh water for irrigation.

(iii) Recycling of metal / plastic waste will conserve metal resources.

(b) **Water Harvesting.** This method can be used for storing rainwater for use at a later date. In villages, storing of rain water in ponds will increase the level of sub soil water.

(c) **Aforestation.** Planting more trees and avoid cutting of trees. This will prevent soil erosion as also increase good gases in the environment.

(d) **Proper Waste Management.** This will prevent pollution of soil and water sources like river, ponds and sea. This not only involves segregation of waste into biodegradable / non biodegradable and its subsequent treatment, but also treatment of industrial / sewage effluents before discharge into the river / sea.

(e) **Greater Use of Renewable Sources.** Using renewable sources of energy like solar and wind power will help in conserving electricity.

(f) **Avoid Wastage.** Excessive use / uncontrolled use leads to wastage. Wastage can be prevented by proper education, monitoring and controlled usage.

(g) **Increasing Energy Efficiency.** Use of energy efficient vehicles or equipment like CFLs will reduce consumption. Also use of alternate sources of energy like solar or wind energy will reduce consumption of electricity.

(h) **Monitoring and Control.** There is a strong need to put into place strong and stringent control and monitoring organizations so that uncontrolled wastage can be prevented.

Role of NCC in Conservation of Natural Resources

12. Every cadet can fulfill his obligation towards environment individually or collectively by following means :-

- (a) Avoiding cutting of trees and by Planting more trees.
- (b) Not polluting water sources like river, ponds, sea.
- (c) Avoiding use of plastic.
- (d) Avoiding noise pollution.
- (e) Recycling natural resources to ensure their efficient sustainable use.
- (f) Using renewable sources of energy like solar and wind power.
- (g) Saving energy in small matters like switching off fans, lights and other electric gadgets when not needed.

CONCLUSION

13. Natural resources are Mother Nature's gift to mankind. These need to be used with discretion. Large scale industrialization, urbanization and massive increase in population are leading to depletion of these meager resources. Natural resources are to be conserved and managed judiciously.

LESSON PLAN: E 2
WATER CONSERVATION & RAINWATER HARVESTING

Period	-	One
Type	-	Lecture
Code	-	E 2
Term	-	I (SD/SW)

Training Aids

1. Computer, Projector, Charts, Pointer. Black Board& Chalk

Time Plan

2.
 - (a) Introduction - 05 Mins
 - (b) Water Conservation - 15 Mins
 - (c) Rain Water Harvesting - 15 Mins
 - (d) Conclusion - 05 Mins

INTRODUCTION

3. Water is a very important and precious resource for survival of mankind. Water Conservation encompasses policies, strategies and activities to manage fresh water as a sustainable resource, to protect the water environment and to meet current and future human demands. Population growth, household size and affluence affect the quantity of water that is consumed. Factors such as climate change will increase pressures on natural water resources, especially in manufacturing and agricultural irrigation. Water is fast becoming scarce due to increase in population, industries and agricultural activities and due to poor rainfall.

AIM

4. To acquaint the cadets about Water Conservation and Rain Water Harvesting.

PREVIEW

5. The lecture will be conducted in following parts:-
 - (a) Part I - Water Conservation.
 - (b) Part II - Rain water harvesting.

PART I : WATER CONSERVATION

Need for Water Conservation

6. No other natural resource has had such an overwhelming response on the history of mankind as much as Water. As human population increases, the desire for a better standard of living will increase the demands on fresh water resources.

7. Much of the world's fresh water is consumed by the agricultural, industrial and domestic sectors. The failure in efficiently managing this resource to meet the increasing water demands of

these sectors has resulted in a situation of crisis in many parts of the world. In many parts of India, freshwater crisis already exists.

8. With only 1% of water available for human consumption, we must treat our water supply with more respect. Water conservation should not be considered an option any longer but is an inescapable necessity. Current circumstances require our full attention, if we hope to thrive as a civilization. Much of the world is currently suffering due to a lack of clean water. Therefore, it is extremely important to seek out, find and start using all the innovative water conservation solutions and methods that are available today.

9. **Ways to Conserve Water Indoors.** The best place to start Water Conservation is one's own house. Certain measures which can be adopted at home are:-

- (a) Ensure that there are no leaks in your house, in the pipelines, taps and toilets.
- (b) Use water efficient flushes and if possible, toilets with dual flushing systems.
- (c) Close taps while brushing your teeth, shaving or soaping your face.
- (d) Use water from washing of clothes for cleaning floors.
- (e) Use appropriate amount of detergent for washing clothes.
- (f) Close the shower tap whilst soaping your body.
- (g) When washing dishes by hand, don't let the water run while rinsing. Fill one sink with wash water and the other with rinse water.
- (h) Monitor your water bill for unusually high use. Your bill and water meter are tools that can help you discover leaks.
- (j) Water your lawn and garden in the morning or evening when temperatures are cooler to minimize evaporation.

10. **Water Conservation Practices for Water Utilities.** Common practices used by water supply utilities include metering, leak detection, repairing water lines, well capping, retrofitting programs, pricing, waste-water reuse and developing public education programs and drought management plans.

11. **Agricultural Water Conservation Practices.** Water saving irrigation practices fall into three categories, field practices, management strategies and system modifications. Practices such as drip irrigation can save large quantities of water. Careful and judicious use of water for irrigation can lead to irrigating much more land.

12. **Industrial and Commercial Water Conservation Practices.** Industries could save copious amounts of water by installing water recycling systems. 'Cooling Water Recirculation' and 'Wash Water Recycling' are the most widely used water recycling practices.

13. Other Methods to initiate Water Conservation would include, public outreach programmes, nukkad and community dramas and water audits. Rainwater harvesting is one of the most successful techniques being used in India.

PART II : RAIN WATER HARVESTING

14. Rainwater harvesting means capturing the runoff of the rainwater in our own house, village, town or city. It basically means accumulation and storage of rainwater for reuse, before it reaches the aquifer. Utilisation includes water for garden, livestock, irrigation, etc. In many places, the water collected is just redirected to a deep pit with percolation. The harvested water can be used for drinking water also, if the storage is a tank that can be accessed and cleaned when needed.

15. **Need for Rainwater Harvesting.** India is in a state of water crisis, both in rural and urban areas. Floods and droughts go hand in hand in this country, which causes water scarcity. Rainwater is a pure form of water if stored properly and can greatly reduce the pressures on treated water supply. Rainwater harvesting is therefore extremely essential for the following reasons:-

- (a) It helps to recharge sub soil and groundwater thus increasing the level of the water table.
- (b) It helps to create large quantity of pollution free potable water that can be stored in huge tanks or ponds for use later on. In cities, it reduces the dependence on treated water supply to a great extent.
- (c) It ensures ready supply of water on the land surface thereby reducing dependence on the groundwater.

Types of Rainwater Harvesting Systems

16. There are a number of ways to harvest rainwater, ranging from very simple to the complex industrial systems. Generally, rainwater is either harvested from the ground or from a roof. The rate at which water can be collected from either system is dependent on the plan area of the system, its efficiency and the intensity of rainfall.

- (a) **Ground Catchment Systems.** Channelise water from a prepared catchment area into a storage system. Generally, this method is only considered in areas, where rainwater is very scarce and other sources of water are not available. They are more suited to small communities than individual families. If properly designed, ground catchments can collect large quantities of rainwater. This method is ideally suited for villages in rural India.
- (b) **Roof Catchment Systems.** Roof catchment systems channelise rainwater that falls onto a roof, into a storage tank via a system of pipes. The first flush of rainwater after a dry season, should be allowed to run to waste as, it will be contaminated with dust, bird droppings etc. Rain Water from the subsequent showers can be harvested. Roofs and pipes should have sufficient incline to avoid standing water. They must be strong enough and large enough to carry peak flows. Storage tanks should be covered to prevent mosquito breeding and to reduce evaporation losses, contamination and *alge* growth. Rainwater harvesting systems require regular maintenance and cleaning, to keep the system hygienic and in good working order. This method is most suited for towns and cities.
- (c) **Subsurface Dyke.** A subsurface dyke is built in an aquifer to obstruct the natural flow of groundwater, thereby raising the groundwater level and increasing the amount of water stored in the aquifer. Example, the subsurface dyke at Krishi Vigyan Kendra, Kannur under Kerala Agricultural University with the support of ICAR, has become an effective method for ground water conservation by means of rain water harvesting technologies. India. The dyke is now the largest rainwater harvesting system in that region.

17. **Groundwater Recharge.** Rainwater may also be used to recharge groundwater where the runoff on the ground is collected and allowed to be absorbed, adding to the groundwater. In India this includes Bawdis and Johads, or Ponds which collect the run-off from small streams in a wide area. In India, reservoirs called tankas were used to store water; typically they were shallow with mud walls. Ancient tankas still exist in some places.

18. **Advantages In Urban Areas.** Rainwater harvesting in urban areas can have manifold advantages. Some of the reasons why rainwater harvesting can be adopted in cities, is to provide supplemental water for the city's requirements, to increase soil moisture levels for urban greenery, to increase the ground water table through artificial recharge, to mitigate urban flooding and to improve the quality of groundwater. In urban areas of the developed world, at a household level,

harvested rainwater can be used for flushing toilets, washing laundry, showering or bathing. It may however require some treatment before it can be used for drinking.

CONCLUSION

19. Water is the only resource for which there is no alternative. Earth sustains life primarily because there is water available on the earth. Inefficient management of this important natural resource has caused a situation of crisis in many parts of the worlds including India, therefore it is very important that we conserve this important commodity.

LESSON PLAN: E 3
WASTE MANAGEMENT

Period	-	One
Type	-	Lecture
Code	-	E 3
Term	-	II (SD/SW)

Training Aids

1. Computer, Projector, Charts, Pointer. Black Board & Chalk

Time Plan

2.
 - (a) Introduction - 05 Mins
 - (b) Types of Waste - 15 Mins
 - (c) Disposal and Management of Waste - 15 Mins
 - (d) Conclusion - 05 Mins

INTRODUCTION

3. Waste Management refers to the collection, transport, processing or disposal, managing and monitoring of waste materials. Waste materials usually relate to materials produced by human activity and the process is generally undertaken to reduce their effect on health, environment or aesthetics. All wastes materials, whether they are solid, liquid, gaseous or radioactive, fall within the gamut of waste management.

AIM

4. To acquaint the cadets about Types of Waste and its Management.

PREVIEW

5. The lecture will be conducted in following parts:-
 - (a) Part I - Type of Waste.
 - (b) Part II - Disposal and Management of Waste.

PART I : TYPES OF WASTE

6. Waste material can be of following types :-
 - (a) **Solid Waste**. This can be further classified into different types depending on their source as under :-
 - (i) Household waste is generally classified as municipal.
 - (ii) Industrial waste as hazardous waste.
 - (iii) Biomedical waste or hospital waste as infectious waste.

- (iv) Electronic wastes such as TV's, refrigerators and computers.
- (b) **Liquid Waste**. This can be classified into following types:-
 - (i) Chemicals released by industries.
 - (ii) Waste water released by households through the sewer lines.
- (c) **Radioactive Waste**. These are wastes that contain radioactive material. Radioactive wastes are usually by-products of nuclear power generation and other applications of nuclear fission or nuclear technology, such as research and medicine. Radioactive waste is hazardous to most forms of life and the environment and is regulated by government agencies in order to protect human health and the environment.
- (d) **Municipal Solid Waste**. Municipal solid waste consists of household waste, construction and demolition debris, sanitation residue and waste from the streets. This garbage is generated mainly from the residential and commercial complexes. This waste comprises of :-
 - (i) Organic waste such as vegetable and fruit peels, leftover foodstuff, etc.
 - (ii) Paper.
 - (iii) Cotton and Woollen clothes.
 - (iv) Wood.
 - (v) Plastic Bags.
 - (vi) Tin, aluminium and other metal items such as cans.
 - (vii) Glass Bottles.
- (e) **Hospital or Bio-Medical Waste**. Hospital waste is generated during the diagnosis, treatment, or immunization of human beings or animals or in research activities in these fields or in the production or testing of biologicals. It may include Soiled Waste, Disposables, Anatomical Waste, Discarded Medicines and Chemical Wastes.
- (f) **E-Waste**. Electronic waste or E-waste as it is popularly called, is a collective terminology for the entire stream of electronic wastes such as Used TV's, Refrigerators, Telephones, Air Conditioners, Computers, Mobile Phones etc.
- (g) **Hazardous Waste**. Sources of hazardous waste mainly include industries like textile, tannery, petrochemicals, pharmaceuticals, pesticides, paint and dye, petroleum, fertilisers, asbestos, caustic soda, inorganic chemicals and general engineering industries. Hazardous wastes contain heavy metals, cyanides, pesticides, complex aromatic compounds (such as PCBs), and other chemicals which are toxic, reactive, corrosive or have a serious damaging effect on the environment.

PART II : MANAGEMENT OF WASTE

Actions by Individuals

7. Some steps which all individuals can take whilst contributing to the waste management may include:-

- (a) Segregation of household waste into bio-degradable and non-biodegradable.
- (b) Reduce use of plastic bags and replace with paper or jute/cloth bags.
- (c) Recyclable waste such as paper, glass, cloth etc could be segregated and disposed off accordingly.
- (d) Keep the surroundings of your house and around the house clean. Do not dump waste just outside the house on the road.
- (e) Colonies could start vermin-composting and natural composting.
- (f) What is waste for you, is wealth for somebody else. There has been a tradition in India of finding an innovative use for everything - tyres, battery cases, plastic bins and what not. Think of reuse of the thing you would like to discard.

Actions by Civic Bodies

8. The major functions of civic body may include the following :-
- (a) Prohibiting littering of street.
 - (b) Organizing house to house waste collection.
 - (c) Conducting awareness programs to disseminate information to public.
 - (d) Providing adequate community storage facilities.
 - (e) Use of colour code bins and promotion of waste segregation.
 - (f) Transport of wastes in covered vehicles.
 - (g) Processing of wastes by adopting an appropriate combination of composting, anaerobic digestion, Pellatisation etc.
 - (h) Up gradation of the existing dump sites and Disposal of inert wastes in sanitary landfills.

CONCLUSION

9. Management of waste is an essential and an inescapable requirement today. We as individuals also have to play our part in handling our household waste and help the government in addressing this major problem.

LESSON PLAN: E 4
POLLUTION CONTROL – WATER, SOIL, AIR AND NOISE

Period	-	One
Type	-	Lecture
Code	-	E 4
Term	-	II (SD/SW)

Training Aids

1. Computer, Projector, Pointer. Black Board & Chalk

Time Plan

2.	(a)	Introduction	-	05 Mins
	(b)	Types Causes of Pollution	-	10 Mins
	(c)	Causes & Effects of Pollution	-	10 Mins
	(d)	Control Measures	-	10 Mins
	(e)	Conclusion	-	05 Mins

INTRODUCTION

3. Pollution means imbalance in the atmosphere caused by pollutants. Air gets polluted with the smoke from homes, factories and vehicles. Water gets polluted by city and factory wastes. Loud noises cause sound pollution. Pollution in fact, spreads diseases and makes life uncomfortable on earth. Man has played a very crucial role in destroying the very essence of life i.e. destruction of forests due to excessive urbanization. Due to increase in population and industrialization, the forests have been exploited for wood from trees and land space. Unscrupulous felling of trees has led to the destruction of the forest cover. Hence the air purifier i.e. the trees which give us oxygen to survive have been depleted. Depletion of greenery and forests and the pollution of the earth's atmosphere have led to reduction of the protective ozone layer and increase in global warming.

AIM

4. To acquaint the cadets about Types of Pollution and its Control Measures.

PREVIEW

5. The lecture will be conducted in following parts:-
 - (a) Part I - Types of Pollution.
 - (b) Part II - Causes and Effects of Pollution.
 - (c) Part III - Control Measures.

PART I : TYPES OF POLLUTION

6. **Soil Pollution.** Today's industrialised society produces a huge amount of garbage, the disposal of such wastes is a major problem, especially in the urban centers. Non-biodegradable wastes such as polythene bags, which cannot be decomposed by natural agents like bacteria have become a menace to the environment besides being health hazards. Use of chemical fertilizers and pesticides containing harmful substances contaminates the soil. Soil may become deficient in nutrients due to excessive cultivation or if the same crop is grown repeatedly on the same plot.

7. **Water Pollution.** Waste-water from our homes, hospitals and factories is usually discharged in to the water bodies. Such water contains excreta, disease-causing micro-organisms and harmful chemicals. It makes water unfit for drinking and may even kill aquatic plants and animals. Harmful substances seeping through earth rainwater contaminate groundwater. Plant nutrients derived from fertilizers and organic wastes like dead bodies thrown into water sometimes cause excessive growth of weeds. Many aquatic organisms die as a result of oil spills from tankers. Leaking pipelines also pollute water organisms. Many species of birds and fish die from contact with oil as it makes feathers and gills inactive.

8. **Air Pollution.** Air pollution is caused mainly by harmful substances emitted into the atmosphere by industries and automobiles. It causes respiratory diseases and affects the skin and eyes. Some of the gases emitted by industries dissolve in rainwater to produce acid rain, which can damage vegetation. Atmospheric ozone which protects us from harmful ultra-violet rays is depleted due to release of certain carbon compounds called chlorofluorocarbons (CFCs) into the atmosphere. This also increases the risk of skin cancer and eye damage in humans.

9. **Sound Pollution.** Sound produced from motor vehicles, trains, aero planes, factories, sound during religious and political public meetings, noise produced by the masses and other living creatures also plays an important role in producing sound pollution. It also affects the health of human beings. Loud sound affects the human heart, create auditory problems and causes mental stress.

PART II : CAUSES AND EFFECTS OF POLLUTION

Causes

10. **Soil & Water Pollution.**

(a) **Discharge of Domestic Waste.** Discharge of untreated domestic wastes like human excreta, urine, washing of kitchen and laundry wastes directly into reservoirs of water courses. The problem is particularly true of unsewered small towns or cities situated close to the flowing rivers.

(b) **Discharge of Industrial Waste.** Industrial wastes comprise of organic and inorganic chemical substances in minute or colloidal suspension which undergo microbial decomposition resulting in products odoriferous or unacceptable in tastes or appearance and are harmful to human beings.

(c) **Discharge of Agricultural Waste.** The agricultural wastes are primarily due to barnyard drainage or washing of chemical fertilizers, insecticides, pesticides and herbicides into surface or ground water sources with the impetus on agricultural development. The increasing use of such chemicals without forethought of health hazard involved is bound to accentuate the pollution problems.

11. **Air Pollution.**

(a) Smoke is produced due to incomplete combustion of coal in industrial plants, locomotives, furnaces etc. About 45% of smoke comes from industrial plants alone.

(b) Dust, salt particle from oceans, pollens, spores, rust etc remain suspended in air and is affected by large air movement, dispersing them into vast areas.

(c) Gaseous impurities from chemical manufacturing industries like sulphur dioxide, benzyl, carbon monoxide acid vapour, fumes etc often combine with the aqueous vapour of the air and then intermingle with the smoke already present in the air.

(d) Chloro Fluoro Carbons (CFCs) used in air conditioning is responsible for depletion of ozone layer of atmosphere.

(e) Automobile exhaust gases in particular, exhaust from trucks and buses, contain products of incomplete combustion, carbon monoxide, hydrogen, methane and unburnt carbon.

12. **Sound Pollution.** This has increased manifold over the years due to following :-

(a) Increase in number of vehicles on the road, excessive use of horns, increase in number of aircraft in the air.

(b) Use of Loudspeakers of extremely high wattage at night.

(c) Excessive use of fire crackers.

(d) Increase in ultrasonic and electromagnetic sound waves from mobile towers.

Effects of Pollution

13. **Soil & Water Pollution.**

(a) The principal effect of pollution is to deplete the excessive organic load, the dissolved oxygen content of receiving water to a point that stream becomes incapable of exercising the self purification process. The de-oxygenation may be sufficient to destroy practically all the aquatic life.

(b) Pollution of stream by causing suspended solids to deposit on the stream bed causing silting, and the organic matter undergoing purification with the solid matters buoyed up by gas rising to the top thus resulting in floating masses of sludge.

(c) Use of polluted water downstream by communities for their daily requirements may cause the sporadic outbreaks of water borne diseases.

(d) Polluted waters are also difficult to be treated and it is found that treatment plants have to incur increased costs in handling such waters.

(e) Agricultural soil becomes unfit for agriculture due to, excessive poisonous chemicals.

(f) Crop produced in contaminated soil or soil irrigated with contaminated water is unfit for human consumption. If consumed, it has short term as well as long-term serious health effects.

14. **Air Pollution.**

(a) Occurrence of diseases like silicosis (respiratory disease), rickets, dental caries.

(b) Deterioration of health in the form of nausea, headache, loss of appetite and irritation due to high sulphur dioxide content in air.

- (c) The incidence of cancer is being increasingly related with the smoke and fumes from industrial plants.
- (d) Smoke severely interferes with normal course of sunshine and visibility resulting in the possibility of untoward accidents.
- (e) Due to sound pollution from mobile towers, many birds like the sparrow have vanished from the cities, disturbing the ecological balance.

Measures to Control Pollution

15. Measures to control pollution include the following:-

- (a) To develop consciousness among common people to control all pollution. Plant more and more trees.
- (b) The use of loud horns or mindless blowing of horns by motor vehicles should be banned.
- (c) The water bodies should not be used as waste reservoirs.
- (d) Various sources of drinking water, and water resources should be well protected so that dirty water does not enter these water bodies.
- (e) Environmental education should be made compulsory in all educational institutions.
- (f) Excessive use of pesticides and insecticides should be avoided.
- (g) In all towns and cities there should be proper arrangement of dustbins to collect garbage being produced in the houses.
- (h) In the factories strict precaution should be instituted to avoid pollution of various types.
- (j) Running of old and pollution emitting vehicle should be banned.
- (k) The pollution control Administrative Authorities must have independent powers to implement their decisions.

Role of the NCC Cadets in Curbing the Menace of Pollution

16. NCC being one of the largest youth organisations has to play a significant role towards the pollution control. A youth can guide and contribute by educating others about the dangers of pollution. We have to respect our environment and natural resources and not pollute the same. Rivers and water bodies must be kept clean as water is an essential resource and it cannot be wasted. In fact every drop has to be saved. Cadets can visit villages and guide the farmers regarding the use of natural manure instead of chemical fertilizer produced after generating industrial waste.

CONCLUSION

17. In order to stop the pollution menace, we need to take help from every individual in society. It is the duty of every NCC cadet, to contribute towards this end through personal example and by educating others about various constitutional rights on the subject of pollution.

LESSON PLAN: E 5
ENERGY CONSERVATION

Period	-	One
Type	-	Lecture
Code	-	E 5
Term	-	III (SD/SW)

Training Aids

1. Computer, Projector, Charts, Pointer. Black Board & Chalk.

Time Plan

2.	(a)	Introduction	-	05 Mins
	(b)	Reasons for Increase in Energy Consumption	-	15 Mins
	(c)	Energy Conservation Measures	-	15 Mins
	(d)	Conclusion	-	05 Mins

INTRODUCTION

3. "ENERGY" means any form of energy derived from fossil fuels, nuclear substances or materials, hydro-electricity and includes electrical energy or electricity generated from renewable sources of energy or bio-mass connected to the grid. Energy conservation refers to various ways and methods of reducing energy consumption by economising on the use of a particular source of energy.

AIM

4. To acquaint the cadets about Energy Conservation.

PREVIEW

5. The lecture will be conducted in following parts:-
 - (a) Part I - Reasons for Increase in Energy Consumption.
 - (b) Part II - Energy Conservation Measures.

PART I : REASONS FOR INCREASE IN ENERGY CONSUMPTION

General

6. The main sources of energy which are under severe strain and in extremely short supply are electricity and fuel. Energy conservation is the management of processes and policies, designed to reduce energy usage. Energy conservation can be achieved only by reducing consumption of energy by, either preventing wasteful use of energy or by using energy efficient products.

7. **Reasons for Increase in Energy Consumption.** Over the years, the rate of energy consumption has been increasing at an alarming speed, leading to various environmental

problems, besides putting extra strain on the meager resources. The major causes for increase in higher energy consumption can be attributed to the following:-

- (a) **Population Explosion**. Exponential population growth has had a direct bearing on the energy consumption. More people means - more requirement of energy per person.
- (b) **Migration of Rural Population to Urban Areas**. Large chunks of rural population have migrated to urban centres including Tier II and Tier III cities in India. This population needs housing, electricity, transport etc which have put a heavy toll on energy consumption.
- (c) **Increased Manufacturing**. Increased manufacturing is the need of the day. However, more energy is required for the same.
- (d) **Increased Number of Vehicles**. As the per capita income of people all over the world is increasing especially in India, there has been a great upsurge in production of vehicles, thus needing increased amount of fuel.
- (e) **Transmission Losses**. Poor infrastructure across the country leads to higher energy losses due transmission or pilferage.
- (f) **Poor Usage Habits of Individuals**. This is one of the most significant reasons for high energy consumption in India. Insufficient knowledge and poor habits cause massive energy wastage.
- (g) **Poor Building Designs**. Buildings made with scant consideration to efficient energy usage were built all over the country thus increasing the consumption.

PART II : ENERGY CONSERVATION MEASURES

- 8. **Energy Saving Building Designs**. Construction of industrial / domestic buildings with energy efficient designs, to reduce the consumption of electricity on air conditioning and lighting.
- 9. **Use of Energy Efficient Equipment / Implements**. Use of energy efficient equipment / gadgets like ACs, Heaters, Tube lights, CFLs, Frost Free Refrigerators, Distribution Transformers, Induction Motors, Direct Cool Refrigerator, Geysers, Ceiling Fans, TVs / LCDs, Agricultural Pump Sets, LPG Stoves and Washing Machines etc contribute immensely in reducing the consumption of electricity. Use of solar lighting / heating gadgets also contributes towards saving large quantity of electricity.
- 10. **Public Lighting**. This is a large consumer of electricity. Hence, energy saving / efficient equipment like CFLs, Halogen Lamps, Distributors and Solar Lighting must be used in a big way to conserve electricity.
- 11. **Usage Habits**. Everyone must be passionate about preventing wasteful use of electricity. Strict measures should be enforced to switch off all lights which are not required during day or at night at homes, offices or public places.
- 12. **Public Transport System**. Efficient, speedy and reliable public transport system with fuel efficient vehicles must be employed. This can reduce a large burden of the fuel energy, by reducing the number of personal vehicles on the road.
- 13. **Energy Efficient Infrastructure**. This includes creation of high quality roads, rails and transmission methods to reduce wasteful use of electric and fuel energy.
- 14. **Preventing Pilferage**. Large quantity of electricity, coal and fuel is pilfered by people during transmission and transporting causing huge losses. This pilferage must be reduced at all costs.

CONCLUSION

15. The increasing preference for commercial energy has led to a sharp increase in the demand for electricity and fossil fuels. There is still a considerable potential for reducing energy consumption by adopting energy efficiency measures at various sectors of our country including individual and collective community level initiatives.

LESSON PLAN : E 6
WILDLIFE CONSERVATION PROJECTS IN INDIA

Period	-	One
Type	-	Lecture
Code	-	E 6
Term	-	III (SD/SW)

Training Aids

1. Computer, Projector, Charts, Pointer. Black Board & Chalk.

Time Plan

2. (a) Introduction - 05 Mins
- (b) Wildlife Conservation - 15 Mins
- (c) Wild Life Projects - 15 Mins
- (d) Conclusion - 05 Mins

INTRODUCTION

3. The Indian subcontinent is blessed with a natural habitat of a large and varied wildlife. We can find some of the most magnificent as well as the rarest wildlife species of the world in the country. The beauty and variety we see in the jungles of India is difficult to be expressed in words. However, the past few decades have seen the greed and negligence of human beings leading to large-scale poaching, habitat destruction, resulting in animal - human conflict with rapid decline in the population of most of the wild animals and birds.

4. Conservation of Wildlife in India has slowly and gradually been understood by all. Today, efforts are being made towards wildlife conservation to preserve this natural wealth. Numerous wildlife conservation projects have been undertaken in India, both, at the government, as well as the individual level, to protect the wildlife of the subcontinent.

AIM

5. To acquaint the cadets about Wildlife Conservation and Projects in India.

PREVIEW

6. The lecture will be conducted in following parts:-
 - (a) Part I - Wildlife Conservation.
 - (b) Part II - Wildlife Projects in India.

PART I : WILDLIFE CONSERVATION

Need for Conservation

7. **Threats to Wildlife.** The major threats being faced by the wildlife in India are:-

- (a) **Decreasing Capacity.** The wildlife sanctuaries of India have become overcrowded and their capacity has decreased to quite an extent. This is one of the major reasons for the depleting population of wild animals in India.
- (b) **Increasing Fatalities.** Tourism in the national parks of the country is increasing day by day. One of the reasons for this is a rise in the popularity of eco-tourism and adventure tourism. This has led to a growth in vehicle pollution increasing wildlife road fatalities, apart from leading to a damage of the natural habitat of birds and animals.
- (c) **Increasing Forest Fires.** Increase in forest fires due to campfires by visitors or deliberate fires by poachers / villagers has had a damaging effect. These fires not only kill animals, but also destroy their natural habitat.
- (d) **Increased Motor Boat Activity.** The wildlife of coastal areas is constantly disturbed by personal watercrafts, like jet skis or wave runners. These personal watercrafts enter shallow waters and expel nesting birds from their roosts. Such activities are disturbing the mating pattern of birds.
- (e) **Release of Chemicals/Toxins.** Releasing of chemicals and other toxic effluents into the water bodies has led to poisoning of the water. The animals and birds drinking such water face a fatal threat. Even the population of fish, living in such water bodies, is declining at a fast pace.
- (f) **Climate Changes.** The climate changes taking place in the world today, are affecting not only humans, but also the wildlife. The natural habitat as well as migration patterns of the animals and birds is experiencing disturb patterns.
- (g) **Increase in Poaching.** The threat of poaching has been haunting the wildlife of India since ages. Even after the establishment of wildlife sanctuaries and national parks, the threat of poaching has not been totally eliminated.

8. **Maintenance of Food-Chain.** Conservation of wildlife is extremely important for sustaining the natural ecosystem. All living organisms of the biosphere are connected to each other by a common factor of food. Animals form a very important part of this food chain and there is a need to maintain equilibrium. Any disruption to this food chain can have major effects. Herbivores and carnivores are required to maintain the appropriate balance of nature. If all lions, tigers and other big cats vanish from the earth, the deer population would increase manifold thus bringing a disastrous effect on the plants and grass. Therefore it is essential that the population of carnivores is maintained through wildlife conservation.

Wildlife Conservation Measures

9. **Wildlife Projects.** Measures to conserve Indian Wildlife include various Projects such as Project Tiger, Jungle Lodges and Nature Camps. These are the measures taken towards the conservation of Indian wildlife. It also includes reduced cutting of trees, since it is clear that when forests are cut down, wildlife is naturally threatened. Some beautiful and interesting species have already become extinct. Further, measures for conservation of Indian wildlife have been taken for curbing secret poaching and shooting that can lead to the complete extinction of rhinoceros, the famous Royal Bengal tiger and the elephant.

10. **Expansion of Sanctuary System.** Habitat creation was another important measure, like for instance, various National Parks, Zoological Parks, Botanical Gardens, Sanctuaries and Biosphere Reserves have been constructed that serve as protected areas for the wildlife. They help in conserving the wild life in their state.

11. **Breeding in captivity** has also helped in the survival of many wild life species.

12. **Mass Awareness and Education.** Another important significant measure of conservation of Indian wildlife is mass awareness and education. Awareness about the endangered species and

wildlife is considered essential for protecting them. People are educated and encouraged to participate in preservation processes of wildlife.

13. **Wildlife Protection Act 1972.** Hunting has been made punishable by law in many countries including India. In 1972, Wildlife protection Act was passed which provides legal protection to wildlife and endangered species in particular.

PART II : WILDLIFE PROJECTS IN INDIA

14. **General.** The need to create wild life projects is to preserve the endangered species. It must be understood that some animal species are more endangered than others, because their numbers have fallen to alarming levels due to poaching, reduction of habitat, pollution of water bodies and other man made disturbances like electromagnetic waves from mobile towers. Some of these projects are funded by the World Wildlife Fund (WWF) while, others are funded by the Government.

15. **Project Tiger.** In order to save the Tiger, the Indian government started the 'Project Tiger' in 1973-74, with the objective of restraining, as well as augmenting the declining population of tigers in the country. Under the project, nine wildlife sanctuaries were taken over and developed into tiger reserves. These reserves were developed as exact replicas of the varied terrains of the country, with their core area being free of any human movement. With time, the number of sanctuaries under the ambit of 'Project Tiger' was increased and by 2003, it had been increased to 27. Project Tiger helped increase the population of these tigers from 1,200 in the 1970s to 1700 in 2011.

16. **Project Elephant.** Project Elephant (PE), is a centrally sponsored scheme, launched in February 1992, to provide financial and technical support to major elephant bearing States in the country, for protection of elephants, their habitats and corridors. It also seeks to address the issues of human-elephant conflict and welfare of domesticated elephants. The Project is being implemented in 13 States / UTs , viz. Andhra Pradesh , Arunachal Pradesh , Assam , Jharkhand , Karnataka , Kerala , Meghalaya , Nagaland , Orissa , Tamil Nadu , Uttarakhand, Uttar Pradesh and West Bengal. 25 Elephant Reserves (ERs) extending over about 58,000 sq km have been formally notified by various State Governments till now. The estimated population of wild elephants is in excess of 25000.

17. **Project Hangul.** The Kashmiri stag also called Hangul is a subspecies of Central Asian Red Deer native to Northern India. This deer lives in groups of two to 18 individuals in dense riverine forests, high valleys and mountains of the Kashmir Valley and Northern Chamba, in Himachal Pradesh. In Kashmir, it is found in the Dachigam National Park, at elevations of 3,035 meters. The population of these deers has fallen from 5,000 animals in the beginning of the 20th century to about only about 150 animals by 1970. However, the state of Jammu & Kashmir, along with the IUCN and the WWF prepared a project for the protection of these animals, named as Project Hangul. This brought great results and the population of this species has now increased to over 340 by 1980.

18. **Crocodile Conservation Project.** The Indian Crocodile Conservation Project is considered among the more successful of conservation initiatives in the world. It has pulled back the once threatened crocodilians from the brink of extinction and placed them on a good path of recovery. The Project has not just produced a large number of crocodiles, but has contributed towards conservation in a number of related fields as well.

19. **Project Sea Turtle.** A significant proportion of world's Olive Ridley Turtle population migrates every winter to Indian coastal waters, for nesting mainly at Eastern Coast I Orissa. The Ministry of Environment & Forests in 1999 has initiated the Sea Turtle Conservation Project in collaboration with UNDP, with the objective of conservation of Olive Ridley Turtles and other endangered marine turtles. The Wildlife Institute of India, Dehradun has been designated as the Implementing Agency. The project is being implemented in 10 coastal States of the country with special emphasis in the State of Orissa.

20. **Vulture Conservation in India.** India has nine species of vultures in the world. The population of three species i.e. White-backed Vulture, Slender-billed Vulture and Long-billed Vulture in the wild has declined drastically over the past decade. The decline of Gyps genus in India has been put at 97% by 2005. Due to this evidence, all three vulture species were listed by IUCN, the World Conservation Union, in 2000 as 'Critically Endangered'. The workshop to prepare an Asian Vulture Recovery Plan held at Parwanoo in Himachal Pradesh, India in February 2004 recommended the establishment of captive holding and captive breeding facilities for three species of Gyps vultures at six different places in South Asia, besides implementing a ban on veterinary use of Diclofenac. These centres would serve as source for reintroduction of the birds after removal of the cause of mortality from the environment.

21. **Indo-Russian Cooperation on Migratory Birds.** MoEF has also signed a protocol with Russian counterpart, for conservation of migratory bird species between the two countries. It has been agreed to develop joint projects of mutual interest on migration and nesting behaviour of Siberian Cranes and common cranes and also to exchange scientific and official information on issues relating to wetland management, conservation of avi-fauna etc.

22. **Other Projects.** After the success of animal projects, the government has now initiated several new projects for conservation of other endangered animals like, The Himalayan Musk Deer Ecology and Conservation Project, Project Lion, Project Snow Leopard and endangered Birds / Pheasant Projects.

CONCLUSION

23. The Indian subcontinent is blessed with a natural habitat of a large and varied wildlife. We can find some of the most magnificent as well as the rarest wildlife species of the world in the country.

INDEX**ADVENTURE TRG**

<u>Ser No</u>	<u>Lesson Code</u>	<u>Subject</u>	<u>Cat</u>	<u>Page No</u>
1.	ADV 1	Para Sailing	SD/SW	285
2.	ADV 2	Slithering	SD/SW	288
3.	ADV 3	Rock Climbing	SD/SW	291
4.	ADV 4	Cycling and Trekking	SD /SW	296

LESSON PLAN : ADV 1
PARASAILING

Period	-	Four
Type	-	Lecture/Demo -1/ Prac - 3
Code	-	ADV1
Term	-	II (SD / SW)

Training Aids

1. Computer Slides, Pointer, Charts, Black board & Chalk.

Time Plan

2.	(a)	Introduction	-	05 Min
	(b)	Parasailing Gear	-	10 Min
	(c)	Types of Parasailing	-	10 Min
	(d)	Parasailing Safety Tips	-	10 Min
	(e)	Conclusion	-	05 Min

INTRODUCTION

3. Parasailing is also known as Parascending or Parakiting. It is a recreational kiting activity where a person is towed behind a vehicle or a boat while attached to a specially designed canopy wing that reminds one of a parachute, known as parasail wing. On land or over water the manned kite's moving anchor may be a car, truck or a boat. Parasailing just by kiting in heavy winds should be discouraged. The vehicle pulling the parasail should have enough pulling power. The parascender has little or no control over the parachute.

4. There are six parts of a parasail. The harness attaches the person to the parasail, which is connected to the vehicle through the tow rope. The sport should not be confused with paragliding. The first international competitions were held in the mid 80's and continue to run today.

AIM

6. To acquaint the cadets about Parasailing as a part of adventure activity.

PREVIEW

7. The lecture will be conducted in following parts :-
 - (a) Part I - Parasailing Gear.
 - (b) Part II - Types of Parasailing & Parasailing Safety Tips.

PART I : PARASAILING GEAR

8. One of the most popular recreational activities today is parasailing. If you have researched parasailing and you have decided that this is something that you would like to pursue there are

many things that you should know prior to making your first launch. One of the most important things that you should consider is the appropriate gear that is involved to perform in parasailing activities. It is also important to have the will and nerve to take your first launch in parasailing. However, if you have the appropriate parasailing gear, parasailing can be easy for anyone who wishes to pursue it. Parasailing gear that will be required to perform this activity is as follows :-

(a) One of the most important things to parasailing is the clothes that you choose to wear while performing this activity. While you have the freedom to wear whatever you want to wear, it is very important that you select clothing that will be comfortable and easy for you to maneuver in. You can actually buy jumpsuits and clothing that are appropriate for parasailing. While many people see this as an added expense, there are many people who see this as an added bonus.

(b) Another important piece of parasailing gear is the actual paraglide. Basically this is a parachute that has the added features of a bar that you can use to help you fly effectively in parasailing.

(c) When you perform in parasailing activities, you should have a harness that you strap that will attach you to the paraglide. This way, if you slip or lose contact with your hands. The harness will help hold you in place.

(b) You may want to purchase a pair of gloves to hold the paraglide with to ensure that your hands are protected while you are flying in parasailing.

(e) Many people choose to have a helmet when they participate in parasailing activities. Many accidents can occur while you are parasailing and it is extremely important that you protected. The head is one area that should be properly protected when you are engaging in parasailing.

(f) You should ensure that the boat that is pulling you along in the air has a experienced driver and the correct amount of fuel. It is important that the boat that pulls you while you are parasailing is sturdy and dependable, You do not want to be up in the air and have your harness fall from the boat. In the same respect you do not want to be parasailing and the boat run out of fuel.

(g) When you decide to go parasailing it is important that you make sure that you have all the proper gear in order to do so. Ensuring that you are prepared and you are safe is the single most important aspect of parasailing gear.

(h) The **Parasailing Equipment** mainly consist of a **Glider**, which in its inflated firm offers resistance to the wind and the air, Then there is a **harness** which is attached to the paraglide and the pilot for safety purpose. **A helmet and a extra parachute** is there for the safety and the emergency landing of the pilot **VARIOMETER** is the main instrument for gauging the ascent and the descent of the pilot.

PARTII : TYPES OF PARASAILING & PARASAILING SAFETY TIPS

9. In India, mainly three type of Parasailing are the most popular ones:-

(a) **Winch Boat Parasailing.** In this sort of Parasailing the ascent and descent of the parasail or takes place from the boat itself. The boat in the sea is well equipped with parasailing equipments. It has a parasail inflation system and hydraulic winch powered by the main drive engine, These two help in launching and retrieving the parasail or from the flight deck.

(b) **Beach Parasailing.** As the name suggests the beach is the main ground for the ascent and descent of the parasail or It is much more complicated than the Which boat

Parasailing , Even the most experienced par sailors are not approved for this without prior permission.

(c) **Platform Parasailing.** In this sort of Parasailing one flies under the winds which are below 5 to 15 mph, away from rough ocean and poor weather conditions and other things close to proximity.

11. **Safety.** Safety tips advised by the Parasail Safety Council are as follows:-

(a) **Licensing.** Make sure you parasail with a fully licensed (state & local) company operating from a well established location insured by a licensed insurance company. Don't pay for your ride on the boat This operator may not have a licensed or be insured.

(b) **Established Operators.** Only parasail with established business operators. Don't be afraid to ask how long they ve been in business if there business permits are current with the City and if the operator onboard is a US Coast Guard Licensed Captain.

(c) **High Winds.** You should avoid parasailing in high wind conditions (over 15 knots at sea level) due to an increased difficulty and complications during emergency water landings updates 09/201.

(d) **Visibility.** Never go up in rain fog or an approaching storm.

(e) **Passenger Age And Weight Restrictions.** Parasailing is not recommend for individuals under the age of 16 or who's exceeds 300 lbs.

(f) **Types of Equipment.** Make certain that you get adequate safety briefing prior to your flight This safety briefing should include, a) a description of the activity itself, b) safety procedures in the event of an unexpected emergencies, C)the porper use signals while landing fire or capsizing e) precluding any participant who appears to be afraid or intimidated prior to their aerial excursion.

(g) **Altitude** Parasailing at an altitude of more than 600 feet is discouraged especially in close proximity to the shoreline or other objects The recommended altitude for using hand signals and recovery during water landings over Open Ocean is 600 and 300 feet over small lakes bays or sounds (figures based on ideal wind and sea conditions with limited traffic).

(h) **Ask Questons.** Ask all the right questions How long have you been in business? Do you have Insurance by a licensed Agent in this State? is good flying weather today?

(j) **Release From.** Read the release form carefully before you sign it. Parasailing does have physical requirements, especially in the event of a water landing.

CONCLUSION

10. A special parachute with wing like extensions that lifts a rider in its harness up and through the air when towed by an automobile or motorboat gives an absolutely thrilling experience It also instills adventurous spirit and develops courage to face the challenges.

LESSON PLAN : ADV 2
SLITHERING

Period	-	Two
Type	-	Lecture Demo
Code	-	ADV 2
Term	-	I (SD/SW)

Training Aids

1. Computer Slides, Charts, Pointer, Black board & Chalk.

Time Plan

2.	(a)	Introduction	-	05 Min
	(b)	General information	-	10 Min
	(c)	Slithering equipment	-	10 Min
	(d)	Uses and techniques of slithering	-	10 Min
	(e)	Conclusion	-	05 Min

INTRODUCTION

3. The literal definition of the word slithering is to slide or glide, like a reptile. This can be better explained as descending from a height, most of the times a bridge, slowly at a controlled pace and touch the surface underneath. the thrill in this sport is to see the ground coming closer and closer as you descend down and feel the wind in your hair and with no support besides a rope, which one is tied with.

4. **It is also known as fast roping. Fast-roping**, also known as **Fast Rope Insertion Extraction System (FRIES)**, is a technique for descending a thick rope. It is useful for deploying troops from a helicopter in places where the helicopter itself cannot touch down. First developed by the British with UK rope manufacturer Marlow Ropes, its first combat use was during the Falkland War . The original rope was a thick nylon that could be used in a manner akin to a Firepole. The special ropes used today are braided (plaited), which results in pattern on the outer circumference that is not smooth and so is easier to grip. Originally, each person would hold the rope for the next person; however this has been phased out.

AIM

5. To acquaint NCC cadets with Slithering as an adventure activity.

PREVIEW

6. The lecture will be conducted in following parts:-
 - (a) Part I - General Information.
 - (b) Part II - Slithering Equipment.
 - (c) Part III - Equipment Usage and Slithering Techniques.

PART I : GENERAL INFORMATION

7. Slithering is quicker than abseiling (rappelling), although more dangerous, particularly if the person is carrying a heavy load, because the rope is not attached to them with a descender . The person holds onto the rope with his gloved hands and feet and slides down it. The British method advises not to use the feet as this can make the descent for following personnel more dangerous because boot polish or the leather of the boot can make the rope extremely slippery. Several people can slide down the same rope simultaneously, provided that there is a gap of approximately 3 meters (9.8 ft) between them, so that each one has time to get out of the way when they reach the ground. The rope must be thick, typically 40 millimeters (1.6 in) diameter, to prevent it from being wildly jerked about from the rotor blast of the helicopter. It is essential to wear gloves , as sliding down a rope generates great heat from friction.
8. Fast roping onto a ship can take approximately 30 seconds, and is used when a rapid build up of boarding forces is required.
9. What can go wrong? Three things:
- (a) You can see in the first video that people who are fast-roping are vulnerable to small arms fire, both as they exit the helicopter and as they descend the rope.
 - (b) People who are new to fast-roping can misjudge their speed and land hard. This can also happen if the backpack weighs a hundred pounds or the gloves are too thin (the following 17-second video may contain one expletive at the end, but contains an excellent example of a fast-roping error).

PART II : SLITHERING EQUIPMENT

10. **Equipment.**
- (a) **Rope.** The rope has to be that thick for two reasons. Firstly if it is too thin it is hard to grip and causes too much friction (even with gloves). Secondly if it is too thin, all the wind from the props down wash will whip it around. Worst case scenario is that a thin rope somehow whips into the main rotor or the tail rotor. The rope should meet the following specifications:-
 - (i) The rope should be made of polyester aramide.
 - (ii) The diameter of the rope should be 12mm.
 - (iii) The rope should have a working load of minimum 700 Kgs.
 - (iv) The rope should have a tenacity of minimum 700 K.
 - (b) **Gloves.** Each member of the team must wear proper fast rope gloves when sliding down the rope. The gloves need some thought as well. Braking your descent with your hands means friction and therefore heat. Too much heat can be a real problem, so thick or padded gloves are preferred. You do not want to fast-rope with a pair of thin gloves or bare hands.
 - (c) **Boots.** They must also wear a reliable pair of boots to provide support both in the slide and the landing.
 - (d) **Helmet and Knee Pads.** It is advisable that protection such as a helmet and knee pads be worn to protect the soldier in the event of a rough landing.

PART III : USES AND TECHNIQUES OF SLITHERING

12. **Uses.** Slithering is most commonly used in three situations which make landing a helicopter a potential safety hazard which are as follows :-

- (a) When ground is soft or uneven making for a dangerous landing situation.
- (b) Deployment into an urban setting with low building rooftops can be completed using a fast rope without having to find a large clearing to set down the helicopter.
- (c) A slithering deployment can be used when there is risk of fire from the opposition as fast roping shortens the time required to get the soldiers down and on to the ground, then the helicopter moved is out of danger.

13. **Techniques.** Proper technique for the sliders is essential in ensuring that an individual on the line does not deploy too fast, risking injury on landing or falling off the line altogether. Going too slowly can cause a logjam, forcing a longer deployment time. To fast rope, the soldier grabs onto the rope with both hands then steps out of the helicopter. Using both feet the soldier pinches the rope between their boots and then increases the pressure on the rope to regulate their speed.

CONCLUSION

14. Fast roping is an insertion technique used by Special Forces in the military to deploy into a location rapidly. Whether the helicopter carrying the soldiers cannot land because of the terrain or because of fire on the helicopter from enemy forces on the ground, dropping fast ropes allows the soldiers to disembark safely and the helicopter to leave the dangerous area. Although fast roping has many benefits, it is not without its risks to the soldiers deploying. While the helicopter is deploying the troops it is a sitting duck, a situation which led to the famous "Black Hawk Down" encounter in Somalia in which helicopters deploying US Special Forces troops were shot down. Additionally, if the helicopter is forced to perform evasive maneuvers it can endanger soldiers on the rope or near the exit to the helicopter, as can a loss of grip as a soldier is sliding down the rope.

LESSON PLAN : ADV 3
ROCK CLIMBING

Period	-	Five
Type	-	Lecture -1 / Demo/Practice - 4
Code	-	ADV 3
Term	-	II / III (SD/SW)

Training Aids

1. Computer Slides, Charts, Pointer, Black board & Chalk.

Time Plan

2. (a) Introduction - 05 Min
- (b) Rock Climbing Equipment - 10 Min
- (c) Rock Climbing Techniques - 10 Min
- (d) Safety Tips - 10 Min
- (e) Conclusion - 05 Min

INTRODUCTION.

3. **Rock climbing** is an activity in which participants climb up, down or across natural rock formations or artificial rock walls. The goal is to reach the summit of a formation or the endpoint of a pre-defined route without falling. Rock climbing competitions have objectives of completing the route in the quickest possible time or the farthest along an increasingly difficult route.

AIM.

4. To acquaint NCC cadets with Rock Climbing as a part of Adventure training.

PREVIEW.

5. The lecture will be conducted in following parts :-
 - (a) Part I - Rock Climbing Equipment.
 - (b) Part II - Rock Climbing Techniques.
 - (c) Part III - Safety Tips.

PART I : ROCK CLIMBING EQUIPMENT

8. **A Wide Range of Equipment Is Used During Rock Climbing.** They are as follows :-
 - (a) **Rope and Webbing.** Ropes used for climbing can be divided into two classes:-
 - (i) **Dynamic Ropes.** These are designed to absorb the energy of a falling climber, and are usually used as Belaying ropes. When a climber falls, the rope stretches, reducing the maximum force experienced by the climber, their belayer.

- (ii) **Low Elongation Ropes.** Low elongation ropes are also called static ropes which stretch much less, and are usually used in anchoring systems. They are also used for abseiling (rappeling) and as fixed ropes .
- (b) **Webbing Or "Tape" Made Of Nylon.** When webbing is sewn or tied together at the ends, it becomes a sling or runner. Webbing has many uses such as:-
- (i) Extending the distance between protection and a tie-in point.
 - (ii) An anchor around a tree or rock or an anchor extension or equalization.
 - (iii) Makeshift harnesses.
 - (iv) Carrying equipment (clipped to a sling worn over the shoulder).
 - (v) Protecting a rope that hangs over a sharp edge (tubular webbing).
- (c) **Carabiners.** Carabiners are metal loops with spring-loaded gates (openings), used as connectors and they are primarily made from steel. There are two major varieties: locking and non-locking carabiners.
- (d) **Quickdraws.** Quickdraws (often referred to as "draws") are used by climbers to connect ropes to bolt anchors, or to other traditional protection, allowing the rope to move through the anchoring system with minimal friction.
- (d) **Harnesses.** A harness is a system used for connecting the rope to the climber. There are two loops at the front of the harness where the climber ties into the rope at the working end using a figure eight knot. Most harnesses used in climbing are pre-constructed and are worn around the pelvis and hips, although other types are used occasionally.
- (e) **Belay Devices.** Belay devices are mechanical friction brake devices used to control a rope when belaying. Their main purpose is to allow the rope to be locked off with minimal effort to arrest a climber's fall.
- (f) **Rappel Devices (Descenders).** These devices are friction brakes which are designed for descending ropes. Many belay devices can be used as descenders.
- (g) **Ascenders.** Ascenders are mechanical devices for ascending on a rope. They are also called Jumars.
- (h) **Helmet.** The climbing helmet is a piece of safety equipment that primarily protects the skull against falling debris.
- (j) **Climbing Shoes.** Specifically designed foot wear is usually worn for climbing to increase the grip of the foot on a climbing wall or rock face.
- (k) **Belay Gloves.** Belay gloves are constructed from either leather or a synthetic substitute. They typically have heat resistant padding on the palm and fingers.

PART II : ROCK CLIMBING TECHNIQUES

9. A climbing technique is any type or combination of body posture , movement, or hold used in climbing. These are described as follows:-

- (a) **General Terms.**
- (i) **Arm Bar, Elbow Bar.** Jamming an arm into a crack and locking it into place.

- (ii) **Bridging or Stemming**. Climbing a corner with the legs apart, one against each face, with the feet relying on friction or very small holds.
- (iii) **Campusng**. Campusing arms. The word itself is derived from the power training done on a set of campus boards.
- (iv) **Chest Jam**. Jamming the torso into a wide crack, for resting.
- (v) **Chimneying**. Climbing between opposing rock faces, with the back and hands against one face, and the feet against the other face, or alternating between both.
- (vi) **Crimp or Crimping**. Grabbing on to a hold with the fingertips alone.
- (vii) **Dyno**. The term is an abbreviation of dynamic maneuver. Using the momentum of a movement or jump to reach a hold beyond your reach. Ideally, gravity brings the movement to a stop at the "dead point", i.e., when the hands reach the hold. When using this technique, the climber often leaves all contact with the wall.
- (viii) **Egyptian, Drop Knee or Lolotte**. Method for reducing tension in arms when holding a side grip. One knee ends up in a lower position with the body twisted towards the other leg. It can give a longer reach as the body and shoulders twist towards a hold.
- (ix) **Egyptian Bridging**. The same position as bridging, but with one leg in front and one behind the body.
- (x) **Extremity Jams**. Jamming involves taking advantage of a body part in a crack for the friction it produces to support a share of body weight.
- (xi) **Gaston**. Pulling sideways and outwards, akin to opening a pair of sliding doors. Normally cracks are climbed by jamming hands or fingers—or any part of the body that fits—in the crack to hold oneself.
- (xii) **Heel Hook**. Using the back of the heel to apply pressure to a hold, for balance or leverage; this technique requires pulling with the heel of a foot by flexing the hamstring. This technique is notable since in most forms of climbing one uses the toes to push.
- (xiii) **Laybacking**. Climbing a vertical edge by side-pulling the edge with both hands and relying on friction or very small holds for the feet.
- (xiv) **Manteling or Mantel Shelving**. Boosting upwards using only the arms and ending with arms fully extended downwards. The motion is akin to getting out of a swimming pool without using the ladder.
- (xv) **No-hands Rest**. Method for resting without using the hands, such as standing on footholds, or using a knee bar (jamming a knee into a large crack).
- (xvi) **Smearing**. Relying solely upon the friction of a flat surface, usually with the feet, to keep from falling. This is possible primarily due to the sticky rubber soles ubiquitously used in modern climbing shoes.
- (xvii) **Toe Hook**. A toe hook is securing the upper side of the toes on a hold. It helps pull the body inwards—towards the wall. The toe hook is often used on overhanging rock where it helps to keep the body from swinging away from the wall.

(b) **Jams Using Feet.**

(i) **Foot Jam.** This technique is also known as the heel-to-toe jam. It involves jamming the foot into a larger crack by twisting the foot into place, the contact with the crack being on the heel and toes.

(ii) **Toe jam in a crack:** When the foot is too large, the toe jam is used by locking the toes into a crack and lowering the heel down.

10. **Flagging.** Where one foot is not placed on a foot hold and the leg is held in a position to maintain balance, rather than to support weight. This is often useful to prevent barn-dooring. The flagging foot may be pressed against the wall or may simply hang in space depending on what will best maintain balance.

11. **Basic Flagging Positions.**

(a) **Normal Flag.** Where the flagging foot stays on the same side, (e.g. flagging with the right foot out to the right side of the body).

(b) **Reverse Inside Flag.** Where the flagging foot is crossed in front of the foot that is on a foot hold.

(c) **Reverse Outside Flag.** Where the flagging foot is crossed behind the foot that is, on a foot hold.

PART III : SAFETY TIPS

12. Use the following 10 tips to keep safe when you're out rock climbing:-

(a) **Always Check Harnesses.** After you've geared up, always check that both the climber's and belayer's harness buckles are doubled back.

(b) **Always Check Knots.** Before you start climbing, always double check that leader's tie-in knot (usually a Figure-8 Follow-Through) is tied right and finished with a backup knot. Also check that the rope is threaded through both the harness waist loop and the leg loops.

(c) **Always Wear a Helmet.** A climbing helmet is essential if you want to live long and prosper. Always wear one when climbing or belaying. Helmets protect your head from falling rocks and from the impact of falling.

(d) **Always Check the Rope and Belay Device.** Before you lead a route, always double check that the rope is properly threaded through the belay device. Also, always make sure the rope and belay device are attached with a locking carabineer to the belayer's harness.

(e) **Always Use a Long Rope.** Make sure your climbing rope is long enough to reach the anchors and lower back down on a sport route or to reach a belay ledge on multi-pitch routes. When sport climbing, if you have any doubt that the rope is too short, always tie a stopper knot in the tail end to avoid being dropped to the ground.

(f) **Always Pay Attention.** When you're belaying, always pay attention to the leader above. He's the one taking the risks of a fall. Don't visit with other climbers at the base, talk on a cell phone, or discipline your dog or kids. Never take the leader off belay unless you are absolutely certain he is tied in and safe and he communicates that to you.

(g) **Always Bring Enough Gear.** Before you climb a route, always eyeball it from the ground and determine what you need to bring. You know best. Don't rely strictly on a

guidebook to tell you what to bring. If it's a sport route, verify visually how many bolts need quick draws. If in doubt—always bring more than you think you need.

(j) **Always Climb With the Rope Over Your Leg.** When you're leading, always make sure the rope is over your leg rather than between them or behind one. If you fall with the rope in this position, you will flip upside down and hit your head. Wear a helmet for protection.

(k) **Always Properly Clip the Rope.** Make sure you always clip your rope through carabineers on quick draws correctly. Avoid back clipping, where the rope runs front to back rather than back to front in the carabineer. Make sure the carabineer gate faces opposite your direction of travel, otherwise the rope can come unclipped. Always use locking carabiners on important placements.

(l) **Always Use Safe Anchors.** At the top of a pitch or route, always use at least two anchors. Three is better. Redundancy keeps you alive. On a sport route, always use locking carabineers if you're lowering down to top-rope off the anchors.

CONCLUSION

13. Rock climbing is a physically and mentally demanding sport, one that often tests a climber's strength, endurance, agility and balance along with mental control. It can be a dangerous sport and knowledge of proper climbing techniques and usage of specialized climbing equipment is crucial for the safe completion of routes. Because of the wide range and variety of rock formations around the world, rock climbing has been separated into several different styles and sub-disciplines. While not an Olympic event, rock climbing is recognized by the International Olympic Committee as a sport.

LESSON PLAN : ADV 4
CYCLING / TREKKING

Period	-	Four
Type	-	Lecture/Practice
Code	-	ADV 4
Term	-	III (SD/SW)

Training Aids

1. Computer Slides, Pointer, Black board & Chalk.

Time Plan

- | | | | | |
|----|-----|--------------|---|--------|
| 2. | (a) | Introduction | - | 05 Min |
| | (b) | Cycling | - | 15 Min |
| | (c) | Trekking | - | 15 Min |
| | (d) | Conclusion | - | 05 Min |

INTRODUCTION

3. **Cycling** on refers to cycling over long distances – prioritizing pleasure and endurance over utility or speed. Cycling can range from single day rides to multi-day trips. Tours may be planned and organised by the Cadets for themselves and also for organizing rallies for various Social activities to spread awareness as well as to convey a message to people in remote and far flung areas.

4. **Trekking** is a long, adventurous journey undertaken on foot, in areas where common means of transport are generally not available. Trekking is not necessarily mountaineering. It is walking for a number of days, usually on uncharted paths, in challenging environments which are likely to be hilly or mountainous. The Himalayan routes are famous for attracting a large number of trekkers.

AIM

5. To acquaint the cadets about Cycling and Trekking as a part of Adventure Activity.

PREVIEW

6. The lecture will be conducted in following parts :-

(a)	Part I	-	Cycling and Safety Measures.
(b)	Part II	-	Trekking and safety Measures.

PART I : CYCLING AND SAFETY MEASURES

Types of Cycle Touring / Expeditions

7. In cycling distances vary considerably. Depending on fitness, speed and the number of stops, the rider usually covers between 50–150 kilometres (30–90 miles) per day. A short tour over a few days may cover as little as 200 kilometres (120 miles) and a long tour may go right across a country or around the world. Various types of expeditions are as follows:-

- (a) **Lightweight Touring**. Informally called *credit-card touring*, in this a rider carries a minimum of equipment and a lot of money. Overnight accommodation is in youth hostels, hotels, or Bed & Breakfast houses. Food can be bought at cafes, restaurants or markets.
- (b) **Ultralight Touring**. This differs from credit card touring in that, the rider is self-sufficient but carries only the bare essentials and no frills.
- (c) **Fully Loaded Touring**. Also known as *self-supported touring*, cyclists carry everything they need, including food, cooking equipment, and a tent for camping. Some cyclists minimize their load, carrying only basic supplies, food, and a Bivouac sack or lightweight tent.
- (d) **Expedition Touring**. In this the cyclists travel extensively, often through developing nations or remote areas. The bicycle is loaded with food, spares, tools, and camping equipment so that the traveler is largely self-supporting.
- (e) **Mixed Terrain Cycle-Touring**. Also called rough riding, cyclists travel over a variety of surfaces and topography on a single route, with a single bicycle. Focusing on freedom of travel and efficiency over varied surfaces, cyclists often adopt an ultralight camping approach and carry their own minimal gear.
- (f) **Supported Touring**. Cyclists are supported by a motor vehicle, which carries most equipment. This can be organized independently by groups of cyclists or commercial holiday companies. These companies sell places on guided tours, including booked lodging, luggage transfers, route planning and often meals and rental bikes.
- (g) **Day Touring**. These rides vary highly in their size of the group (from solo cyclists, group rides, to large organized rides with hundreds to thousands of riders), in their length (from a few miles to Century rides of 100 miles — or longer), in their purpose (from riding for pleasure to raising money for a charitable organization) and in their methods of support (from self-supported day rides, to organized rides where cyclists pay for support or accommodations provided by event organizers — including rest and refreshment stops, marshalling to aid safety, and SAG service).

Safety Measures During Cycling

8. The following guidelines and procedures are required to be followed for the safe conduct of the cycling or cycling expedition / tours:-

- (a) **Qualified Supervision**. All unit, district, council, and national event activities must be supervised by a mature and conscientious adult at least age 21 who understands and knowingly accepts responsibility for the safety of children in his or her care, who is experienced with the skills and equipment involved in the activity, and who is committed to compliance with these BSA safety guidelines.
- (b) **Physical Fitness**. Biking is strenuous. Long treks and hill climbing should not be attempted without training and preparation. For scouting activities, all participants must present evidence of fitness with a complete health history from a physician, parent, or legal

guardian. The adult supervisor should adjust all supervision, discipline, and protection to anticipate any potential risks associated with individual health conditions. In the event of any significant health conditions, proof of an examination by a physician should be required by the adult leader.

(c) **Helmets and Clothing**. All cyclists must wear a properly sized and fitted helmet approved by either the Snell Memorial Foundation, CPSC, or ASTM standard. Layer your clothing for warmth on cool days so you can avoid chilling or overheating. Cover up for sun protection on clear days.

(d) **Buddy System**. When the program activity is a bicycle expedition or trek, the buddy system must be used. When a program element emphasizes individual performance skills, one buddy observes while the other takes his turn. In competitive activity where the buddy concept cannot be applied practically, all activity must be directly observed by the adult supervisor. (Youth members should be taught that biking with a buddy is best. When biking alone, apart from scouting activities, youth members should be encouraged to tell someone their route, schedule, and destination before departing.)

(e) **Position in Traffic**. Ride with the traffic flow, as far to the right as is safe. Avoid curbs, storm drains, soft or loose gravel on shoulders, and other hazards.

(f) **Safety Rules**. Obey all traffic laws, signs, signals, and street markings. Watch for changes in road conditions. Ride only one to a bike. Do not ride after dark. No stunts -- trick riding is only for professionals who use special equipment. Yield to motor vehicles even if you think you have the right-of-way. Never hitch a ride on another vehicle. Keep your head and ears open and do not wear headphones while riding.

(g) **Turns and Intersections**. Look left, right, back, and ahead before turning. Stop and search all directions when entering a street from a driveway, parking area, sidewalk, or alley. Signal all turns using universal hand signals. Walk your bike through or across busy intersections.

(h) **Equipment**. Ride only a bike that fits you. Select a bike that permits you to put both feet on the ground while standing over the top tube. The handgrips should be no higher than your shoulders or lower than your seat.

(j) **Bicycle Accessories**. Every bike needs a horn or bell and reflectors (front, back, and sides). Items should be carried only in baskets, in saddlebags, or on a rear carrier rack. If you must ride in traffic, a bike- or helmet-mounted mirror is recommended. For long trips, a bike-mounted container for drinking water is recommended.

(k) **Maintenance**. Keep your bike clean and well maintained, especially the brakes and drive chain.

(l) **Racing**. Open street racing is dangerous. Race only with supervision on marked courses that have been set up to exclude other vehicle or pedestrian traffic, to eliminate fall hazards and minimize collision risks. Clearly define "start" and "finish" points.

(m) **Planning**. Plan both the route and timing of bike trips to avoid heavy traffic and hazardous conditions. Biking is unsafe on wet pavement and on windy days. Plan for at least hourly rest stops and a maximum of approximately six hours on the bike per day.

(n) **Discipline**. All participants should know, understand, and follow the rules and procedures for safe biking, and all participants should conscientiously and carefully follow all directions from the adult supervisor.

PART II : TREKKING AND SAFETY MEASURES**Trekking Gear / Material**

9. Each trek teaches oneself how to appreciate the beauty of nature, how to get adjusted with the situation and the importance of planning. A well planned trek will allow you to enjoy it and avoid any inconvenience. A list of items which are essential for such an activity are listed below:-

- (a) A good rucksack in proper condition.
- (b) Clothing incl wind cheater, woollens as per your requirements of the stay and season in which trek is going to be done.
- (c) Water, food and cooking utensils (if you are going to cook your own food).
- (d) Camera and its accessories (if interested in photography, always carry an extra pair of batteries and camera roll).
- (e) First Aid box.
- (f) Sleeping Matt or Sleeping Bag.
- (g) Oral rehydration solution (ORS).
- (h) Rope.
- (j) A good pair of shoes.
- (k) Cap (preferably of cotton)
- (l) Toiletry items.
- (m) Torch and batteries.
- (n) Marker and chalk.

Useful Hints / Tips for Trekking

10. Before setting out for a trek, following hints and tips are required to be considered during the planning phase carefully:-

- (a) Keep toilet items handy. This will ensure that no germs/infection enters the body through consumption of water or food.
- (b) Carry all possible essentials in the ruck sack with the expedition. Heavy items could be ferried by road.
- (c) Carry sleeping mattress or durrie for night halts.
- (d) Carry adequate woollens for the period of the trek.
- (e) Take off your shoes at drink and lunch halts. This will give relaxation to your feet.
- (f) Take small steps when ascending up slope.

- (g) Ensure good consumption of water at regular intervals.
- (h) Carry essential medicines to cater for minor injuries or disorders.
- (j) Acclimatisation is a must for high altitude marches.
- (k) Wear appropriate clothing to prevent dehydration, sunburn and fatigue.

Safety Measures for Trekking

11. To make your trip more adventurous and safe, do follow certain safety guidelines and tips mentioned below:-

- (a) Before heading for your adventure trekking trip, do study weather forecast of that area. Avoid trekking during bad weather or adverse climatic situations.
- (b) Newbie's should always carry a raincoat or windsheeter with them. Climate can change frequently in several trekking points.
- (c) Do carry multi-pocket carry bag engrafted with zipper closure and cushioned shoulder straps, especially for trekking trips. The bag should be spacious enough to carry all the important trekking essentials while trekking.
- (d) Must keep a lighter, Swiss army knife, space blanket, water bottle and winter attire in your carry bag or pocket before heading for trekking.
- (e) To prevent insect bite, do wear full sleeves shirts and full pants. Do carry sleeping bag and trekking rope of about 50 meters of length with you.
- (f) A direction compass and topographical map is must while trekking in mountains.
- (g) An ice cutting axe should always be carried if heading into snowy terrain.

Health Guide For Trekking

12. Following precautions should be taken for having a trouble free trek:-

- (a) Accessories add grace to your personality. During travel keep such accessories which are easy to carry and may add grace to your overall look.
- (b) While planning your trekking trip, it is preferable to have a medical fitness check up done. It is most essential to be fit and fine before heading for trekking. You may also prefer to have medical precautions against diseases like malaria, cholera, tetanus, typhoid and hepatitis. Do arrange and carry medicines related to ailments from which you are previously suffering.
- (c) If suffering from any kind of ailment, do carry proper prescribed medicines to prevent serious health problem including heatstroke, sever headache, cough, dehydration and hypothermia.
- (d) Always wear proper trekking shoes while trekking. Uncomfortable pair of shoes can harshly hurt your feet and can lead to serious foot injuries while trekking. Therefore do spend some time to arrange proper and comfortable trekking shoes before heading for trekking tour.
- (e) Choose those trekking shoes that are a half-size bigger than your regular shoes to allow space for some swelling caused while trekking and to hold heavier trekking socks.

- (f) Do carry food items which carry larger amount of carbohydrates.
- (g) Always take important medicine and first aid box with you.
- (h) Do always cover your neck area, particularly in frequently changing weather .It can lead to serious neck problems and pains if left uncovered.
- (j) Do wear thick woolen socks or stockings while trekking. Synthetic blended socks can be used for trekking purpose, as these socks are specially designed to preclude feet moisture.

CONCLUSION

13. Cycling and Trekking are a very enjoyable and satisfying adventurous activity, in which proper health and fitness is must for every trekker. It instills confidence, sense of achievement and team spirit amongst the trekkers. It also adds to your knowledge and awareness about the nature and environment. This activity can be undertaken by people of all ages, provided you are physically fit.

INDEX**OBSTACLE TRAINING**

<u>Ser No</u>	<u>Lesson Code</u>	<u>Subject</u>	<u>Cat</u>	<u>Page No</u>
1.	OT 1	Obstacle Training	SD/SW	303

LESSON PLAN : OT 1
OBSTACLE TRAINING COURSE

Period	-	Six
Type	-	Lecture/Practice
Code	-	OT 1
Term	-	I / II / III (SD/SW)

Training Aids

1. Obstacle Course, Chart, Pointer, Black board & Chalk.

Time Plan

2.	(a)	Introduction	-	05 Min
	(b)	Obstacle Course	-	15 Min
	(c)	Demo	-	15 Min
	(d)	Conclusion	-	05 Min

INTRODUCTION

3. The training in negotiating the obstacles by NCC cadets is a very important aspect of NCC curriculum. The obstacle course training not only makes the cadets physically tough but develops a very high degree of confidence and inculcates the qualities of patience and courage to face challenges.

AIM

4. To acquaint the cadets about Obstacle Course Training.

PREVIEW

5. The lecture will be conducted in following parts:-
 - (a) Part I – Introduction to Obstacles and Method of Negotiation.
 - (b) Part II – Practice in Negotiating the Obstacle Course.

PART I : OBSTACLE COURSE

6. The Standard Obstacle Course that the NCC cadets are required to negotiate consists of ten obstacles. The obstacles, depending upon the structure are constructed of wood, bricks, concrete and mud. Each obstacle is placed at an distance of about 30 feet from each other. The details of each obstacle course are given in the succeeding paragraphs.

- (a) **Straight Balance**. It is a wooden plank of 3 inches thickness, 4 inches width and 12 ft in length, which is 1 ½ ft above ground level. A cadet crosses this obstacle running, keeping his arms open and balancing his body.

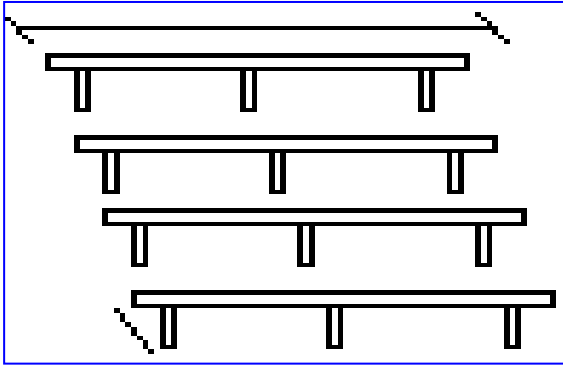

Straight Balance

(b) **Clear Jump**. Its structure is just like a straight beam. This wooden beam is 2 ½ ft from the ground. Cadet has to jump over it without touching or using any part of the body.

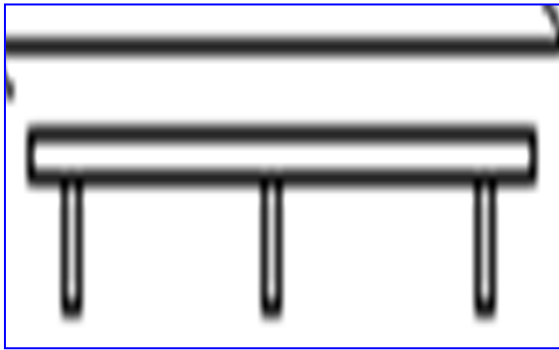

Clear Jump

(c) **Zig-Zag Balance**. It is a Zig-Zag a structure of wooden beam 18 ft in length, with 3 inch width and 1 ½ ft above the ground and is constructed in a zig-zag manner. The Cadet has to cross the obstacle lengthwise with open hands and balancing the body similar to straight balance.

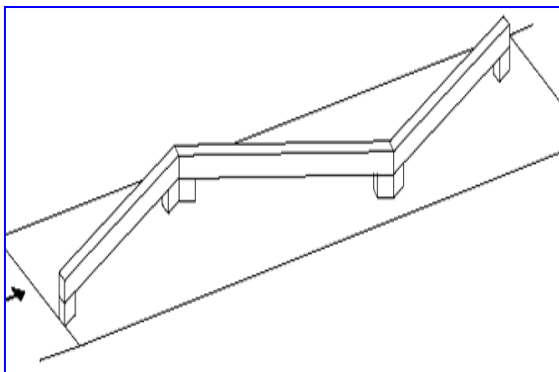

Zig Zag Balance

(d) **High Wall**. It is a 6 feet high and 12 feet long brick wall with plaster on both sides. For crossing this obstacle, a cadet has to run, jump, kick the wall with one leg and take leap putting both hands on the wall and then push his body upwards and jump over the other side.

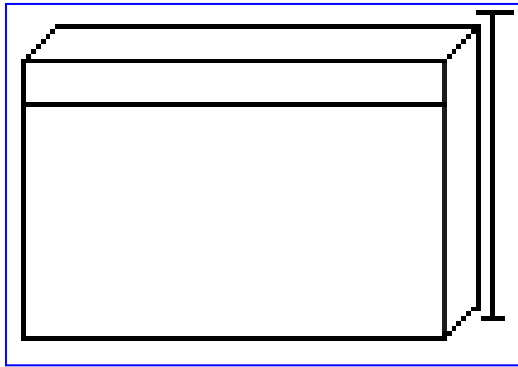

High Wall

(e) **Double Ditch**. The obstacle is composed of two ditches each of approximately 6-8 ft in length, 4-5 ft wide and 3-4 ft deep separated by a small gap of approx 9-12 inch. The Cadet have to jump across the two ditches by jumping over the first ditch, placing one foot on the gap and jumping across the second ditch.

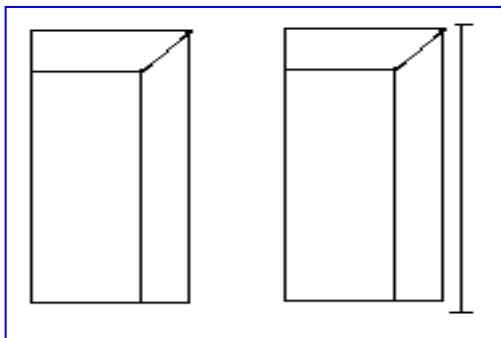

Double Ditch

(f) **Right Hand Vault**. This wooden structure is 3 ½ ft above the ground and 1 ½ feet long. The Cadet is required to jump over using the right hand as support on the beam, throwing both leg up and jump across.

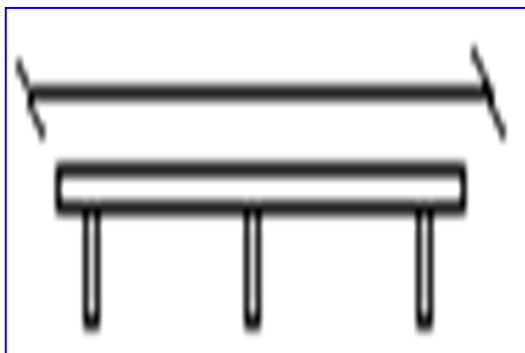

Right Hand Vault

(g) **Left Hand Vault.** This wooden structure is 3 ½ ft above the ground just like Right Hand Vault. The Cadet is required to jump over using the left hand as support on the beam, throwing both leg up and jump across.

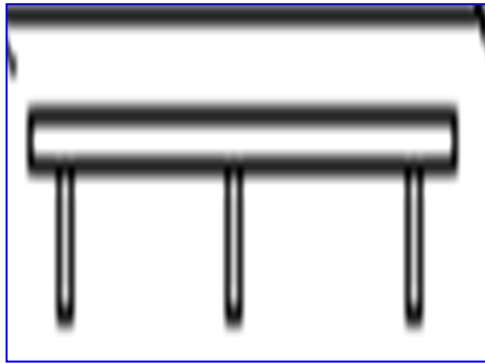

Left Hand Vault

(h) **Gate Vault.** This is a wooden structure which has two beam at height of 3 ft and 5 ft respectively, both 18 ft long. Once has to cross the gate by holding upper beam with both hands and by putting one's feet on 3 ft gate and jump across.

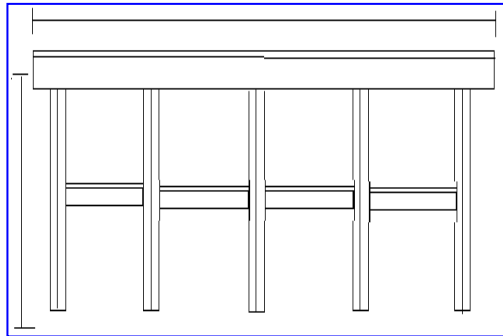

Gate Vault

(j) **Ramp.** It is a 15 feet long, 18 feet wide and 4 ½ feet high sloppy hillock. For crossing it a cadet has to run in and climb over the ramp and take long jump after reaching the top and landing on a pit on both the feet.



Ramp

(k) **Straight Balance.** It is a wooden plank of 3 inches thickness, 4 inches width and 12 ft in length, which is 1 ½ ft above ground level. A cadet crosses this obstacle running, keeping his arms open and balancing his body.

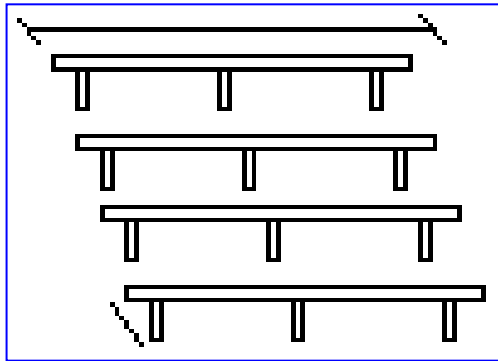

Straight Balance

7. **Safety Measures.** Following Safety Measures must be ensured during the conduct of Obstacle Course training to cadets

- (a) Suitable and physically fit cadets only to be selected.
- (b) Training to be given first in PT dress, later on with packs and weapon.
- (c) Emphasis to be given on closing of individual timings and later team timings.
- (d) Wet and slippery obstacles and area to be avoided.
- (e) Obstacles to be done under supervision of qualified instructors and correct technique only to be used.
- (f) Arrangement of first aid to be ensured.

8. **Benefits.** Benefits of Obstacles courses are as under:-

- (a) Ensures physical fitness.
- (b) Ensures agility
- (c) Ensures mental robustness.
- (d) Coordination and balance of mind and body.
- (e) Improves risk taking ability.
- (f) Evaluating problem solving skills.
- (g) Over all team spirit.

PART II : DEMONSTRATION

9. The demonstration will be given by a trained cadet under the supervision of PI Staff.

CONCLUSION

10. The training in NCC is comprehensive. The basic training of regular Defense services (Army, Navy and Air force) is imparted to the students. The cadets receive training throughout the NCC tenure. Intensive training is given to cadets in the camps especially in Thal Saink Camp. Obstacle course is one such training activate conducted for making the NCC cadets physically fit and mentally robust. Obstacle training infuses Courage, patience and makes them physically fit.

INDEX**PERSONALITY DEVELOPMENT AND LEADERSHIP**

<u>Ser No</u>	<u>Lesson Code</u>	<u>Subject</u>	<u>Cat</u>	<u>Page No</u>
1.	P 1	Introduction to Personality Development	SD/SW	310
2.	P 2	Factors Influencing / Shaping Personality : Physical, Social, Psychological and Philosophical	SD/SW	315
3.	P 3	Self Awareness – 1	SD/SW	318
4.	P 3	Self Awareness – 2	SD/SW	323
5.	P 3	Self Awareness – 3	SD/SW	326
6.	P 4	Change Your Mind Set	SD/SW	329
7.	P 5	Interpersonal Relationship and Communication	SD/SW	333
8.	P 6	Communication Skills – 1	SD/SW	337
9.	P 6	Communication Skills – 2	SD/SW	341
10.	P 6	Communication Skills – 3	SD/SW	346
11.	P 7	Leadership Traits	SD/SW	349
12.	P 8	Types of Leadership	SD/SW	353
13.	P 9	Attitude – Assertiveness and Negotiation	SD/SW	356
14.	P 10	Time Management	SD/SW	361
15.	P 11	Effects of Leadership with Historical Examples	SD/SW	369
16.	P 12	Stress Management Skills	SD/SW	374
17.	P 13	Interview Skills	SD/SW	380
18.	P 14	Conflict Motives – Resolution	SD/SW	389
19.	P 15	Importance of Group / Team Work	SD/SW	394
20.	P 16	Influencing Skills	SD/SW	398
21.	P 17	Body Language	SD/SW	404
22.	P 18	Sociability : Social Skills Ettiquettes And Mannerism	SD/SW	411
23.	P 19	Values / Code of Ethics	SD/SW	416

LESSON PLAN : P 1
INTRODUCTION TO PERSONALITY DEVELOPMENT

Period	-	One
Type	-	L/P
Code	-	P 1
Term	-	I (SD/SW)

Training Aids

1. Computer Slides, Charts, Marker Pens, Black Board, Chalk.

Time Plan

2.	(a)	Introduction	-	05 Min
	(b)	Understanding Various Skills	-	15 Min
	(c)	Understanding the Concept of Life Skills	-	15 Min
	(d)	Conclusion	-	05 Min

INTRODUCTION

3. An individual's personality is the complex of mental characteristics that makes them unique from other people. It includes all patterns of thought and emotions that cause us to do and say things in particular ways. Personality development is, developing a personality so as to create a strong positive impression about self with the targeted group. It is very important to maintain one's personality to prove in a long run.

AIM

4. To appraise cadets about Personality Development and enhancing the same through application of Life Skills.

PREVIEW

5. The class will be conducted in the following parts:-
 - (a) Part I - Life Skills vs Other Skills.
 - (b) Part II - Define the Concept of Life Skills.
 - (c) Part III - Practical use of Core Skills in daily life.

PART I : LIFE SKILLS VS OTHER SKILLS

6. The class will be introduced to subject by activity method.

7. **Activity – Skills.**

- (a) **Step1.** Write the words 'SKILLS' in big bold letters on the flipchart. Ask the participants to name a few skills they are familiar with.

(b) **Step 2.** Categorize the responses as Vocational, Functional, Literacy, Language, Numeric skills, Cultural, Recreational and Life Skills.

(c) **Step 3.** Initiate a discussion on the following topics:-

- (i) The difference between skilled and unskilled persons.
- (ii) Why is it necessary to have skills?
- (iii) How does one acquire skills?
- (iv) Why should the skills be enhanced?

8. Based on the brainstorming session the following will be elaborated about the various types of skills:-

- (a) **Literacy Skills** : Reading, writing and arithmetic skills.
- (b) **Language Skills** : Communicating using a language in writing and speech.
- (c) **Functional Skills** : Filling up bank forms to deposit or withdraw money, able to read map, booking railway tickets, fix a fused bulb or leaky tap etc.
- (d) **Vocational Skills** : Enhancing livelihood opportunities – carpentry, tailoring. Making handicrafts, fisheries etc.
- (e) **Sports Skills** : Capable of playing on the field as part of a team or as a single player.
- (f) **Cultural Skills** : Capacity to lighten the spirits of the group he or she belongs to with activities that can break the monotony. For example, use of jokes, energizers etc.
- (g) **Life Skills** : Self-awareness, empathy, creative thinking, critical thinking, effective communication, interpersonal relationship, decision making and problem solving, coping with stress, coping with emotions.

PART II : THE CONCEPT OF LIFE SKILLS

9. Skills are acquired through practice and patience. A skilled person uses less time, energy and resources to do a job and produces quality results. Enhancing Life Skills enables us to adapt to situations and people and helps us to lead a healthy and positive life.

10. The class will now be introduced to definition by WHO “Life Skills are abilities for adopting positive behaviour that enable individuals to deal effectively with the demands and challenges of everyday life”- WHO.

11. There are ten core Life skills which helps in enhancing the personality of an individual. They are as follows:-

- (a) **Self Awareness.** Recognition of “self”, our character, our strengths and weaknesses, desires, likes and dislikes, and skills. Being aware of the good points about oneself helps young people build a sense of self-esteem and self-confidence. Being aware

of their weaknesses will make young people be willing to learn more. This also helps them utilize the opportunities available to them in relation to their abilities. Self-awareness is necessary for developing a positive attitude towards life.

(b) **Empathy.** Is the ability to be sensitive to another person's situation, to understand his/her concerns, worries, fears and needs and how they feel. Empathy works wonders when we apply it to our relationships – with our loved ones, classmates, parents, friends, cousins and colleagues. It helps us move closer to solutions, to resolve conflicts, and enhance our quality of life.

(c) **Critical Thinking.** Is the ability to analyze information and experience in an objective manner. It can help us recognize and assess the factors that influence our attitude and behavior, such as media and peer pressure influences.

(d) **Creative Thinking.** Creativity is the ability to generate new ideas by combining, changing, or reapplying existing ideas. It helps us to look beyond our direct experience, and to respond adaptively and with flexibility to situations in our daily lives.

(e) **Problem Solving Skills.** Enable us to deal with problems in our lives in a constructive manner. The process of problem solving involves various steps. They are identifying the problem, exploring the available alternative and deciding on the best possible solution.

(f) **Decision Making.** Decision making is to choose from the varied options based on the existing knowledge of the topic under consideration keeping in mind the positive or negative consequences of each of the option.

(g) **Interpersonal Relationship.** Ability to establish positive relationships helps us to relate in positive ways with the people we interact with. This means being able to make and maintain friendly relationships, which can be of great importance to our mental and social well being. It may also mean being able to end relationships constructively. Positive relationships help in the growth of the individuals involved.

(h) **Effective Communication.** Is the ability to express, verbally through spoken or written language and non-verbally through gestures and body movements, in ways that are culturally acceptable.

(j) **Coping with Emotions.** Being aware of the predominant emotion that preoccupies the mind at any point of time, knowing how emotions influence behavior, and being able to respond to emotions appropriately.

(k) **Coping with Stress.** Means recognizing the source of stress in our lives, recognizing how this affects us physically and emotionally, and acting in ways that help us control our levels of stress, by changing our environment or life style and learning how to relax.

PART III : USE OF CORE SKILLS IN DAILY LIFE

12. Now the class will be introduced to the practical use of core life skills through a daily life activity.

(a) **Activity – Life Skills In Daily Life.**

(i) **Step 1 - Game Kho-Kho.** Inform the participants that it is time For 'Kho-Kho', a popular game in rural and urban areas. Both teams of boys and girls can play this game. Randomly divide the participants into two teams and ask them to organize the game and play. Observe the process adopted by the groups (who

takes the leadership, how they organize themselves, how they interact with each other, whether they function as a team, what decisions are being made, body language used and how they carry on the game etc.).

(ii) **Step 2 - Analysis of the Game for Understanding Life Skills.** On completion of the game, initiate an interactive discussion to understand their experience in the whole process and their feelings while playing the game. The following questions may be asked:-

- (aa) Who took the lead?
- (ab) Who gave instructions?
- (ac) Was there team work?
- (ad) Was there any pressure on the team to perform? How did the team cope up with that?
- (ae) Was there a chance for the team to perform better than what they did? If yes, why?
- (af) How was the communication between the opponents? (Body language, sign language, shouting etc.)
- (ag) Was there any new technique used in the game?
- (ah) If someone got hurt, how did the others feel about it?
- (aj) Who resolved problems in the team? (A player not moving fast enough or not actively participating).
- (ak) Who cheered the team?
- (al) Who pointed out the shortcoming of the game?

(ii) **Step 3.** On completion, explain the game in terms of Life Skills:-

- (aa) **Self Awareness.** What strength and weakness each one has – (can run very fast, very strong etc.).
- (ab) **Empathy.** Response of the team members when one of them gets hurt.
- (ac) **Critical Thinking.** Think how the opponent is planning the next move; identify the shortcomings of the game.
- (ad) **Creative Thinking.** Use a new technique to capture a player.
- (ae) **Effective Communication.** Verbal and non-verbal communication within and between teams.
- (af) **Interpersonal Relationship.** Accepting other team members as friend and being with them as a team.
- (ag) **Critical Thinking, Problem Solving and Decision Making.** When someone did not play as per team's requirement to decide to change the strategy immediately.

(ah) **Coping with Stress.** Stress of not being caught, not being eliminated for not following rules or for foul play, to win the game along with others.

(aj) **Coping with Emotions.** Reaction on winning or losing the game.

13. The following story of **“Hunter and Pigeons”** will be narrated to the class and Life skills therein will be internalized through Brain Storming Session.

14. **Story of Hunter and Pigeons.**

(a) A group of pigeons enjoyed the fresh grains in a field every day. One day a hunter spotted them and decided to catch them. He spread a net in the field and waited for them to come. The pigeon were caught in the net. They realized that the hunter will take them away soon. The leader pigeon said, “We have to get out. There must be a way out. Let us think.” But they could not find a way out. The net was strong. Each pigeon tried to escape by pulling the net indifferent directions. But it is increased the fear and confusion among them more than helping them.

(b) A young pigeon said, “Why don’t we all try and fly together instead of trying to escape individually? When we pull individually, we waste our energy.” The leader pigeon was not in agreement. He said, “No it may be difficult.” But the young pigeon insisted that they try it once. The leader finally agreed when he spotted the hunter at a distance. When he said “fly all of them lifted together and flew away with the net. The hunter arrived at the scene to see the pigeons fly away together as one group with his net.

15. **Life Skill Used by the Characters.**

(a) **Self – Awareness.** The pigeons knew that they were in trouble and had to find a way out of the net.

(b) **Creative by the Hunter.** Spreading grains under the net to catch the pigeons.

(c) **Creative Thinking by the Pigeons.** Identified a creative solution of flying together.

(d) **Critical Thinking.** The young pigeon identified that they were wasting energy and time by trying to fly individually.

(e) **Decision Making.** They decided to fly as a group.

(f) **Effective Communication.** The young pigeon assertively communicated his suggestion of flying together.

(g) **Interpersonal Relationship.** The young pigeon could make suggestion to the leader without fear.

CONCLUSION

16. Life Skills help in building self-confidence and self-esteem and enable us to adapt to situations and people. Life skills are learnt from our own experience, perceptions, insight, stories, books, parents, teachers, religion, media, culture etc. Life Skills are presents in every individual. To get the best out of them we need to sharpen them regularly.

LESSON PLAN : P 2
FACTORS INFLUENCING / SHAPING PERSONALITY :
PHYSICAL, SOCIAL, PSYCHOLOGICAL AND PHILOSOPHICAL

Period	-	Two
Type	-	L/P
Code	-	P 2
Term	-	I (SD/SW)

Training Aids

1. Computer Slides, Charts, Marker Pens, Black Board, Chalk.

Time Plan

- | | | | | |
|----|-----|---|---|--------|
| 2. | (a) | Introduction | - | 05 Min |
| | (b) | Physical and Social Factors | - | 35 Min |
| | (c) | Psychological and Philosophical Factors | - | 35 Min |
| | (d) | Conclusion | - | 05 Min |

INTRODUCTION

3. Personality is the characteristics and patterns of feelings, thoughts, and behaviors, which make a person exceptional, one of a kind and exclusive to his or herself. Personality originates within an individual and remains consistent throughout life. People are different from one another is evident. Every person born is unique to his or herself. Including identical twins, they differ in fingerprints and personalities. A healthy self-image is the core determining factor of a strong personality. Your personality is your identity; it is the sum total of your inherent and acquired characteristics. It is not necessarily something you are born with, but something you definitely need to take responsibility for it is primarily you alone, who can shape your personality and create your reality.

AIM

4. The aim of this class is to acquaint the cadets about the Factors Influencing / Shaping Personality.

PREVIEW

5. The class will be conducted in the following parts:-

(a)	Part I	-	Physical and Social Factors Influencing / Shaping Personality.
(b)	Part II	-	Psychological and Philosophical Factors Influencing / Shaping Personality.

PART I : PHYSICAL AND SOCIAL FACTORS INFLUENCING / SHAPING PERSONALITY

6. Traditionally, modern psychological studies suggest that factors such as the ones below have a lasting effect on an individual's personality.
7. **Hereditary.** Your personality can be influenced by the genes you may have inherited from either your mother's or your father's side or a combination of both. Apart from inheriting physical attributes, like height, weight and skin/hair colour, psychologists have ascertained that our mental aptitudes and temperaments which have the potential for influencing our personality, are to a certain extent, hereditary.
8. **Self-Development.** Of the other factors, self-development is the most important factor that can influence one's personality. Self-awareness is the key; it entails believing in oneself and one's capabilities. It implies that despite one's family and environmental background or one's current circumstance, one remains in control/charge of molding his/her personality. Such a person is aware that personality is a changing, evolving process and does everything possible to enhance his/her personality.
9. **Environment.** Our environment can also play a significant role on our personality. Right from early childhood through all the stages of development, our home and family, our school and teachers, our friends and colleagues at work, all exert influence on the development of our personality. Besides these, the location where we live and the society we associate with, the country of our birth and the culture we have adopted, are all critical factors that influence our personality.
10. **Education.** Education falls into two categories; school smarts and street smarts. Thus, the most effective way of shaping one's personality is to have a taste of both types and experience both worlds. School smarts are the knowledge gained from school while street smarts are the learning that came from even the most unlikely sources.
11. **Life-situations.** Our situations in life are constantly changing and these can affect our personality in varying degrees. Some have greater opportunities in life like better amenities, better schools and greater advantages than others. Learning skills, life skills, communicative skills and language skills although partially latent in some, can only be acquired through personal effort and gained through practice and experience. Hence it is our competence in handling life-situations that can positively influence our personality.

PART II : PSYCHOLOGICAL AND PHILOSOPHICAL FACTORS INFLUENCING / SHAPING PERSONALITY

12. A healthy self-image is the core determining factor of a strong personality. Your personality is your identity; it is the sum total of your inherent and acquired characteristics. It is not necessarily something you are born with, but something you definitely need to take responsibility for it is primarily you alone, who can shape your personality and create your reality.
13. **Past Experiences.** Experience is one of the major determinants of personality, it could affect a person either positively or negatively. For instance a person who has harsh experiences of say, being left behind, may display characteristics of distrust and may isolate himself from others. On the other hand, good experiences can fuel us either consciously or subconsciously to be motivated to work towards achieving the same results. People respond depending upon their experiences whether good or bad.
14. **Dreams and Ambitions.** Dreams and ambitions shape our personality in a way that it facilitates our goals. We start to set priorities and change the way we are in order for such priorities to be fulfilled. Hence, these aspirations are perhaps the strongest factors that develop our attitude towards work and career.

15. **Self-Image.** Each person views himself quite different from how other people perceived him. Thus, one's self-image usually breeds personality characteristics that stick within the self-image. People who feel highly with their selves display a certain aura of confidence and make it always seem that they are a cut above the rest.

16. **Values.** Personality of an individual is greatly influenced by the values a person strongly believes in. A person who adheres to high moral standards is a well-respected member of the society. He is known for his integrity and is trusted by not only his family members, but also by his colleagues and friends. The characteristics of such a person having a strong moral fiber ingrained into his character, can have a significant influence on the personality of an individual.

CONCLUSION

17. In reality, you may be playing many roles i.e. husband/wife, mom/dad, son/daughter, teacher/ student, boss/employee; each of these enact different aspects of your personality and require a different set of behavior and responsibilities. A combination of the roles you play each day, becomes the sum total of your personality. Developing a fine personality can be within anybody's grasp. It can be attained through systematic steps in personal development. It can be the direct result of man's positive attitude combined with all the above factors. In the final analysis, it is your skill in maintaining a balanced approach to making your life healthier and happier.

LESSON PLAN : P 3
SELF AWARENESS - 1

Period	-	Two
Type	-	L/P
Code	-	P 3
Term	-	I (SD/SW)

Training Aids

1. Flipchart, Marker pens, Pictures of / original gift items, Copies of the stories Hunter and the Pigeons, Crocodile and the Monkeys.

Time Plan

2.	(a)	Introduction	-	05 Min
	(b)	Dimensions of Self Awareness	-	35 Min
	(c)	Self-Exploration and Self-Realization by SWOT Analysis	-	35 Min
	(d)	Conclusion	-	05 Min

INTRODUCTION

3. Self-awareness sounds very simple - after all don't we know ourselves. But if we are blatantly honest with ourselves, we might become uncomfortable and experience stress since we will see our deficiencies and failure. Self-awareness is a unique human capacity. Self-awareness is the concept that one exists as an individual, separate from other people, with private thoughts. Self-awareness is a personal understanding of the very core of one's own identity. Self-awareness includes our recognition of ourselves, our character, strengths, weaknesses, desires and dislikes. It can help us to recognize when we are stressed or feel under pressure. It is often a pre-requisite for effective communications, interpersonal relationship and developing empathy for others.

AIM

4. The aim of this class is to know various dimensions of self-awareness and to know one self with the help of a Johari Window exercise.

PREVIEW

5. The class will be conducted in the following parts:-

- | | | | |
|-----|---------|---|--|
| (a) | Part I | - | Dimensions of Self Awareness. |
| (b) | Part II | - | Self-realization and Self exploration through SWOT Analysis. |

PART I : DIMENSIONS OF SELF AWARENESS

6. Self-awareness involves knowing ourselves and our personality, and accepting oneself in spite of our imperfection. It includes all aspects of our selves – our thoughts, emotions, likes, dislikes, strengths, weaknesses, fears, fantasies, ambitions, values, priorities, goals, desires,

needs, etc. It acknowledges the fact that I may be imperfect, but still I like myself since I am a good human being and possess many qualities. To have complete self awareness one needs to concentrate on two aspects the first being how we perceive ourselves our strengths, weakness, abilities etc and secondly how others perceive us. Both the views together gives a person a complete picture about one self.

7. Every person perceives oneself in three aspects as:-

- (a) The perceived self--the way we see that part of ourselves.
- (b) The real self--the way we truly are.
- (c) The ideal self--the way we would like to be in that area.

8. Unhappiness and poor adjustments in persons are mainly because of discrepancies between the perceived and the real or ideal self. These unhappiness and poor adjustments are due to misperceptions of self which there by leads to discontentment.

9. The following dimensions of Self-awareness will be dwelt with as many people limit their self awareness to their bio-data which is usually things known by everybody. However at a deeper level there is so much inside each one of us that it has many dimensions :-

(a) **Self Realization.** Self-realization is the ultimate of self-awareness when one realizes one self and the requirement of their existence in the world.

(b) **Self Knowledge or Self Exploration.** This is a process through which we undo or explore ourselves. This exploration and understanding and knowledge about three important areas Physical self- Knowledge about our own body, Social self – Knowledge about how we relate and interact with society; whether we are social, extroverts or introverts; helping nature; empathetic, etc. Inner self – Knowledge about our goals, dreams, aspirations, secrets, fears, etc.

(c) **Self Confidence.** Self-confidence builds in from self-esteem and this is possible only one is completely aware about ones abilities and limits. Success, appreciation, care, love etc, are factors that boost up the self-confidence.

(d) **Self Talk.** These automatic thoughts can be positive or negative. Some of our self-talk comes from logic and reason. Other self-talk may arise from misconceptions that we create because of lack of information. This is the endless talks and conversations that runs through our minds through the day. This is also a strategy for raising ones' self-confidence if one practices positive thinking.

(e) **Self Motivation.** Self-Motivation is what makes an individual work towards a goal or target, not for external reasons but because of his own internal will to do it. It is an important quality required by everybody to do various activities like studying, working, earning and building relationships.

(f) **Self Esteem.** Self-esteem or self-worth includes a person's subjective appraisal of himself or herself as intrinsically positive or negative to some degree. Developing high self-esteem would improve our self-confidence, the way we look at ourselves, what we can do for ourselves, our well-being, our relationships and our happiness.

(g) **Self Image.** Self-image is how one perceives himself – positively or negatively. Self-image is important because how one feels and thinks about himself affects the way he acts. Self-image about our body is called body image, which is very often a cause for low self-esteem. By body image one is keeping in mind both internal and external aspects of it.

(h) **Self Control.** The ability to control your thoughts, emotions, urges, desires, fantasies, actions is called self-control. It is part of our will power, and includes delayed gratification.

(j) **Self Purpose.** This is the ability to find a purpose for ourselves in relation to this world. What are our goals in terms of family, friendships, career, hobbies, interests. When taken to the extreme –what are our goals in terms of our own selves in this world and universe – that is self-realization.

(k) **Individuality and Uniqueness.** Every single human being is born in this world with different qualities inherent and later they acquire some as they live and learn. This helps individuals to become unique in skills giving them an identity of their own. This describes their individuality and describes each and every person in an different manner.

(l) **Personality.** Personality can be defined as the distinctive and characteristic patterns of thought, emotion and behavior that define an individual's personal style of interacting with the physical and social environment. Our personality has various dimensions, including our openness, conscientiousness, nature, etc. There are numerous courses available for personality development.

(m) **Values.** Value is a concept that describes the beliefs of an individual or culture. Love, care, courage, bravery, respect, integrity and compassion, and respecting our elders are examples of values.

(n) **Attitude.** Attitude is a mindset – the 'way' we think and look at things. All of us, at one time or another, express the three different types of attitudes: positive, negative and neutral. Attitude is the way you look at things. Half a glass of water may appear half empty to one and half full to another.

(o) **Character.** This is defined as the collective qualities or characteristics that distinguish a person, including his reputation, morals and will power.

PART II : SELF REALIZATION AND SELF EXPLORATION **THROUGH SWOT ANALYSIS AND JOHARI WINDOW**

10. An interesting way to become self aware is the use of SWOT analysis. A SWOT analysis focuses on the internal and external environments, examining strengths and weaknesses in the internal environment and opportunities and threats in the external environment. The table below will give you a clear understanding.

INTERNAL	Your Strengths	Your Weaknesses
EXTERNAL	Opportunities in Your Career Field	Threats in Your Career Field

11. The purpose of a SWOT is to actively promote the identified strengths, minimize weaknesses by planning them out of existence, exploit the opportunities before the window closes and have contingency plans in place to minimize threats before they materialize. While we mention about the strengths we understand – Internal positive aspects that are under control and upon which you may capitalize in planning.

- (a) Work Experience.
- (b) Education, including value-added features.
- (c) Strong technical knowledge within your field (e.g. hardware, software,).
- (d) Specific transferable skills (e.g., communication, teamwork).
- (e) Personal characteristics (e.g., strong work ethic, self-discipline, creativity, optimism, or a high level of energy).
- (f) Good contacts/successful networking.
- (g) Interaction with professional organizations.

12. While we are mentioning about our weakness we intend to include – Internal negative aspects that are under your control and that you may plan to improve:-

- (a) Lack of Work Experience.
- (b) Low Marks, wrong major.
- (c) Lack of goals, lack of self-knowledge, lack of specific job knowledge.
- (d) Weak technical knowledge.
- (e) Weak skills (leadership, interpersonal, communication, teamwork).
- (f) Weak job-hunting skills.
- (g) Negative personal characteristics (e.g., poor work ethic, lack of discipline, lack of motivation, indecisiveness, shyness, too emotional).

13. The above mentioned are the internal factors which are to be included in the SWOT analysis in case of the External factors firstly it's the opportunities – Positive external conditions that you do not control but of which you can plan to take advantage.

- (a) Positive trends in your field that will create more jobs (e.g., growth, globalization, technological advances).
- (b) Opportunities you could have in the field by enhancing your education.
- (c) Field is particularly in need of your set of skills.
- (d) Opportunities for advancement in your field.
- (e) Career path you've chosen provides unique opportunities.
- (f) Strong network.

14. And further while we include threats we should mention – Negative external conditions that you do not control but the effective of which you may be able to lessen:-

- (a) Negative trends in your field that diminish jobs (downsizing).
- (b) Competitors with superior skills, experience, knowledge.
- (c) Competitors who went to colleges with better reputations.
- (d) Obstacles in your way (e.g, lack of the advanced education).
- (e) Limited advancement in your field, advancement is cut-throat and competitive.
- (f) Companies are not hiring people with your degree.

15. This SWOT analysis would help an individual to not only understand oneself and their present situation but also plan for ahead.

CONCLUSION

16. Self-Awareness is called the mother of all skills. It is a thinking skill, a social skill and a coping skill. It is one of the most difficult skills to master. Many great saints spend their life meditating and looking inward but only a few like Buddha actually achieve complete self-awareness. Knowing others is wisdom but knowing oneself is enlightenment – Tao Tzu. Awareness about our self is the first step towards creation. This understanding then gives us the opportunity and freedom to change those things you'd like to change about yourself and create the life you want.

LESSON PLAN : P 3
SELF AWARENESS - 2

Period	-	One
Type	-	L/P
Code	-	P 3
Term	-	II (SD/SW)

Training Aids

1. Computer slides, Flip charts , Marker Pens, Papers, ten strips with numbers 1-10 (each strip will have one number only), Ten (numbered from 1-10) small strips of paper with the following words written on them: Happy, Frustrated, Sad, Angry, Shocked, Shy, Guilt, Jealousy, Irritated, Fearful; Four plain cards, Two face masks/ signs: I have AIDS, I am HIV+ve.

Time Plan

2.	(a)	Introduction	-	05 Min
	(b)	Sympathy vs Empathy and Altruism	-	20 Min
	(c)	Importance of Empathizing with Others	-	10 Min
	(d)	Conclusion	-	05 Min

INTRODUCTION

3. Empathy is an ability to be is the ability to be sensitive to another person`s situation, to understand his/her concerns, worries, fears and needs and how they feel. Empathy works wonders when we apply it to our relationships – with our loved ones, classmates, parents, friends, cousins and colleagues. It helps us move closer to solutions, to resolve conflicts, and enhance our quality of life.

AIM

4. To internalize the concept of Empathy, an important Life skills in the cadets facilitating Personality development and to understand the difference between Sympathy, Empathy and Altruism and appreciate the importance to empathize with others.

PREVIEW

5. The class will be conducted in the following parts:-
- (a) Part I - Sympathy vs Empathy and Altruism.
 - (b) Part II - Importance of Empathizing with Others.

PART I : SYMPATHY VS EMPATHY AND ALTRUISM

6. The class will be introduced to emotions through an interesting Game.

(a) **Step -1.** Tell the participants to shake hands with others and ask each others names. Encourage each participant to shake hands with as many participants as possible within a minute.

(b) **Step- 2.** Tell the participants to share their feelings during the exercise by asking following questions:-

(i) Did you feel comfortable while shaking hands with others?

(ii) What stopped you to do this exercise?

(c) Discuss with the participants that in this exercise, some people would have felt comfortable and some would have been hesitant to shake hands. To know why people feel the way they felt, it is necessary to understand oneself.

(d) **(Note:** If shaking hands is not culturally acceptable just finding names and greeting in the traditional way – for example, saying ‘namaste’ or ‘hello’ may be sufficient. Modify the other steps accordingly).

7. Empathy is the ability to imagine what life is like for another person. Without empathy our communication with others will be one sided and we will be bound to face problems in relationship as we will be indifferent to emotions of others. We have many relationship to nurture with : parents, brothers , sisters, aunt, uncle, cousins, friends and neighbours etc.

8. The class will be open to discussion with the help of following examples to elaborate that Empathy is not Sympathy:-

(a) Rajesh lost his pet dog in an accident :-

(i) His friend laughed when he heard the story. (This is lack of empathy).

(ii) His friend cried along with him. (This is sympathy).

(iii) His friend said, “I understand the loss. Let us see how we can come out of the grief.” (This is empathy).

(b) Reena was bothered that she has more hair on her arms and legs :-

(i) Seema said, “Only people with masculine character will have to excess hair and made fun of her.” (This is lack of empathy).

(ii) Seema said, “I do not know why it is happening like this for you. What can we do? You know, I am also feeling bad with you, believe me.” (This is sympathy).

(iii) Seema said, “I understand your distress. Why can’t we ask our local doctor why this happens? She would be able to help us?” (This is empathy).

(c) Rakesh did not submit his assignment on time due to ill-health :-

(i) His class monitor complained to the class teacher. (This is lack of empathy).

(ii) His class monitor spoke on his behalf and got an extension on the submission date for Rakesh. (This is empathy).

9. **Altruism.** A motive to increase another's welfare, without conscious regard for one's self-interests. It is Self-sacrifice for the benefit of others. Empathy is feeling another's feelings but the arousal of empathy increases helping behavior and gets us closer to **pure altruism**. In this we focus more on the distress of the other person than on our own distress.

PART II : IMPORTANCE OF EMPATHIZING WITH OTHERS

10. Empathy is the ability to understand and accept others who are different from us. It is the ability to imagine what it is like for another person by putting oneself in the other person's place/situation and to understand what he or she is going through.

11. Empathy allows us to find the common ground between ourselves and others. On this ground, we are able to make decisions that benefit ourselves without hurting others.

12. Empathy encourages a positive behavior towards people in need of care and assistance, not to laugh at others who are in need or difficulty. Empathy is most effective when both parties are willing to apply it. Someone however, has to take the lead. If we simply wait for others to empathise with us, it may never happen. If you are a parent, you can make efforts to understand your child first if you are the child, you train yourself to see the viewpoints of your parents first.

13. Empathy works wonders when we apply it to our relationships-with our loved ones class mats, parents, friend, cousins and colleagues. It helps us move closer to solutions, to resolve conflicts, and enhance our quality of life.

CONCLUSION

14. We can reflect empathy by caring for people and animals around us, by sharing people's grief and being with them in difficult circumstances, by assisting differently abled people, by not considering anyone as different or lower and in many other such actions, by helping any animal in pain, by not killing or hurting, by not making fun of people who are different from us, by not considering anyone as different or lower, by not mocking people who may not score high marks or lack talents, by helping those who are in need.

15. No matter what role we play in life, empathy remains the primary tool by which we come to understand and communicate effectively with others.

LESSON PLAN : P 3
SOCIAL AWARENESS - 3

Period	-	Two
Type	-	L/P
Code	-	P 3
Term	-	III (SD/SW)

Training Aids

1. Flipchart, Marker pens, Pictures of / original gift items, Copies of the stories-Hunter and the Pigeons, Crocodile and the Monkeys.

Time Plan

2.	(a)	Introduction	-	05 Min
	(b)	Self Awareness through Activity	-	35 Min
	(c)	Self Awareness – Body Image	-	35 Min
	(d)	Conclusion	-	05 Min

INTRODUCTION

3. Self-Awareness is recognition of “self”, our character, our strengths and weaknesses, desires, likes and dislikes, and skills. Being aware of the good points about oneself helps young people build a sense of self-esteem and self-confidence. Being aware of their weaknesses will make young people be willing to learn more. This also helps them utilize the opportunities available to them in relation to their abilities. Self-awareness is necessary for developing a positive attitude towards life.

AIM

4. The aim of this class is to create Self-Awareness in each cadet of the class and throw light on Body Image.

PREVIEW

5. The class will be conducted in the following parts:-
- | | | | |
|-----|---------|---|----------------------------------|
| (a) | Part I | - | Self-Awareness through Activity. |
| (b) | Part II | - | Body Image. |

PART I : SELF-AWARENESS

6. The Self Awareness class will start with an Activity Method. It is very important to let the class know each other. This will done through a “Warming Up activity”.

7. **Activity – Warming Up.**

(a) **Step - 1.** Tell the participants to shake hands with others and ask each others names. Encourage each participant to shake hands with as many participants as possible within a minute.

(b) **Step - 2.** Tell the participants to share their feelings during the exercise by asking following questions:

(i) Did you feel comfortable while shaking hands with others?

(ii) What stopped you to do this exercise?

8. Discuss with the participants that in this exercise, some people would have felt comfortable and some would have been hesitant to shake hands. To know why people feel the way they felt, it is necessary to understand oneself.

9. (**Note:** If shaking hands is not culturally acceptable just finding names and greeting in the traditional way – for example, saying ‘namaste’ or ‘hello’ may be sufficient. Modify the other steps accordingly).

10. The Self Awareness life skills will be further internalized by another activity as follows:-

11. **Activity – Open Your Heart.**

(a) **Step-1.** Give each participant an A-4 size paper. Ask them to draw an outline of a heart. Then divide the heart into four sections-

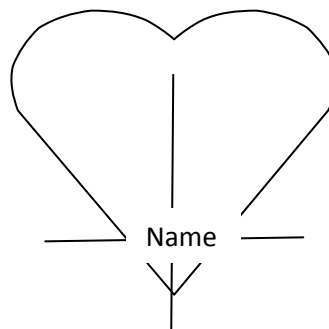

(b) **Step-2.** Encourage them to write down the following inside the heart. Significance / Meaning of their name-in the top left section. If they do not know the meaning of their name, ask them to write their name vertically and then.

PART II : BODY IMAGE

12. The class will be explained about the body image how they have arrived at a particular quality of themselves and all about Body Image.

(a) **What is Body Image?** Body image is the way we perceive our body. It also means how we believe others see our body. It is one of the factors that affects or self-esteem, and influences the way we accept or reject ourselves. It determines whether we feel attractive and confident in society.

(b) **What Decides our Body Image?** Any external factors decide the way we view our body. These may be current fashion fads, role models, comments from parents, media

and peer pressure. By seeing slim models in TV programs, girls get the impression that “thin is in” and therefore try to lose weight and go on diets. With so many fancy advertisements for fairness creams, a dark complexioned boy or girl may have poor body image. Boys may dream of developing muscles like their favourite film heroes. All these concerns are not from their bodies and that of their role model.

(c) **What is Poor Body Image.** A person is said to be suffering from “poor body image” when he/she focuses on the negative (real or imaginary) aspects as perceived by himself or herself about his/her body. The positive aspects are totally or partially excluded by him/her. He/she thus develops poor self-esteem.

(d) **What are the Harmful Effects of Poor Body Image?** Poor or negative body image can produce a feeling of inferiority in the minds of adolescents. It can also lead to anxiety, depression, withdrawal, and in extreme cases, suicide. A lot of money is wasted on attempts to change their bodies. Some people indulge in high-risk behavior, to prove that he/she is attractive to others. A desire to look like an adult also arises due to body image concerns. These may include smoking, consumption of alcohol, substance abuse and unsafe sex. Poor body image is also the cause of many eating disorders seen in adolescent girls and boys.

13. **Tackling Poor Body Image.**

(a) **Enhance Self-Esteem.** This can be done by peers, teachers, family and friends. The positive points of the adolescent should be highlighted to him/her. He/she should be motivated to concentrate on personal strength not related to physique, e.g. hard work, determination, patience, courage etc.

(b) **Build Up Critical Thinking.** “Is physical beauty the only criteria for success / popularity?” Even film stars have to work very hard to make a movie successful. Many successful and famous people may not be very good looking.

(c) **Build up Positive Qualities.** Everyone has some positive qualities. These should be identified and highlighted e.g. caring, confident, hardworking etc.

(d) **Understand Cultural Variation.** The colour of skin and shape of body and facial features vary from country to country and even within a country from state to state. The definition of “beauty” also varies from region to region.

(e) **Dispel Myths Like.** “Being thin is in”, “fair & lovely”, “fair & handsome”.

(f) **Utilise Life Skills.** Life skills like critical thinking and self-awareness can be utilized to promote or develop a positive body image.

CONCLUSION

14. Being aware of the good points about oneself helps young people build a sense of self-esteem and self-confidence. Being aware of their weaknesses will make young people be willing to learn more. This also helps them utilize the opportunities available to them in relation to their abilities. Self-awareness is necessary for developing a positive attitude towards life.

LESSON PLAN : P 4
CHANGE YOUR MIND SET

Period	-	One
Type	-	LEC
Code	-	P 4
Term	-	I (SD/SW)

Training Aids

1. Computer Slides, Pointer, Charts, Black Board and Chalk.

Time Plan

2.	(a)	Introduction	-	05 Min
	(b)	Understanding Mindset	-	10 Min
	(c)	How to Change Mindset	-	20 Min
	(d)	Conclusion	-	05 Min

INTRODUCTION

3. Mindset is something which constantly carries on in a persons mind. It is an attitude towards someone or something. It can form a permanent impression on the mind and is very difficult to change. At times it can develop into a negative attitude leading to disaster. Mindset is a simple idea that makes all the difference. What we say to ourselves each day can be the difference between maintaining the status quo and living the life we dream of and deserve. Most of what holds you back comes from within rather than from the judgements or actions of others. If you want to start making great changes in your life then start with looking at the ways you could be holding yourself back.

AIM

4. To acquaint the cadets about Mindset and how to change it.

PREVIEW

5. The class will be conducted in the following parts:-
 - (a) Part I - What is Mindset.
 - (b) Part II - How to Change your Mindset.

PART I : WHAT IS MINDSET

6. Most people keep a running account of what's happening to them, what it means, and what they should do. In other words, our minds are constantly monitoring and interpreting. That's just how we stay on track. But sometimes the interpretation process goes awry. Some people put more extreme interpretations on things that happen—and then react with exaggerated feelings of anxiety, depression, anger or superiority. Your mindset is the sum of your knowledge, including

believes and thoughts about the world and yourself in it. It is your filter for information you get in and put out. It determines how you receive and react to information. It's often used for a specific part in your life, as in "the mindset of an entrepreneur" or "the growth mindset."

7. Developing the right mindset is the way learning something new and strip out the most relevant information. Then you develop the beliefs that are most helpful for where you want to go or how you want to be. This belief-system is then your mindset. A good mindset will reflect reality and will help you. But not in that order, the order has to be like this:

- (a) Find the beliefs that are most supportive.
- (b) Check if the beliefs are in harmony with (a potential) reality.

8. You want to use your mindset to make a positive change. That's why your beliefs don't necessarily have to reflect your current reality. But of course the reality you believe in should be possible. If you believe "I am a successful entrepreneur", you will act in that way. If you believe "I want to be a successful entrepreneur", you will act in this way too: like you are NO successful entrepreneur. Adopting beliefs that seem slightly out of reach is very powerful. Because it changes your mindset and therefore how you behave. For the better. It let's you grow.

9. In a fixed mindset, people believe their basic qualities, like their intelligence or talent, are simply fixed traits. They spend their time documenting their intelligence or talent instead of developing them. They also believe that talent alone creates success without effort. They're wrong.

10. In a growth mindset, people believe that their most basic abilities can be developed through dedication and hard work. Brains and talent are just the starting point. This view creates a love of learning and a resilience that is essential for great accomplishment. Virtually all great people have had these qualities. Teaching a growth mindset creates motivation and productivity in the worlds of business, education, and sports. It enhances relationships.

PART II : HOW TO CHANGE YOUR MINDSET

11. **Get the Best Information Only.** Try to find the very best information in your field. Then focus on learning this information only. In any worthwhile field there is more information available as needed, especially in the internet. You have to narrow down the information input to the most effective. One of the critical personal skills today is not to find information, but to select the best information and avoid the rest.

12. **Role Model the Best People.** Look for the best people in your field and try to model what they did right. Adopt their kind of thinking and mindset. Follow them. Of course, keep and only add what you think is right for you. That way you can actually improve and personalize their mindset to fit perfectly for you. It's never copying, it's taking what works for you by getting inspiration and quality input.

13. **Examine Your Current Beliefs.** Examine your mindset by looking at your current belief-system. Are these beliefs supporting you or are there self limiting beliefs? You have to identify those possible blocks and turn them around, because whether you know about limiting beliefs or not, they are working in your subconscious mind. To uncover your beliefs ask yourself the right questions about where you want to go and what is standing in your way right now. The key then is to turn those beliefs around by declaring supportive statements on the same belief. To internalize these new supportive beliefs you can make use of affirmations.

18. **Shape Your Mindset with Vision and Goals.** A proactive approach to build your mindset is to clearly see where you want to go. Seeing a vision, images describing your end result clearly in your minds eye, will create a strong pull towards this end result. Then go on and break your vision into goals. It will shape your mindset to become conform with your vision. Learn and

adapt from your own experience and always try to look deeper for the real reasons why you get the results you are getting.

14. **Find Your Voice.** One of the most beautiful things is when you find your very own way, something what you could call finding your voice. To help you find this, answer these four questions.

- (a) What are you good at? That's your mind.
- (b) What do you love doing? That's your heart.
- (c) What need can you serve? That's the body.
- (d) And finally, what is life asking of you? What gives your life meaning and purpose? What do you feel like you should be doing? In short, what is your conscience directing you to do? That is your spirit.

15. **Protect Your Mindset.** One thing you have to do is to protect your mindset against the nay sayers and people who want to drag you down. You also have to protect it against bad information and against overload. Keeping your confidence is a big thing. So please stay on the right path, look to improve yourself and to help others along the way. You can't go wrong with that.

16. **Let Go of Comparisons.** Where you are at this very moment is all that matters. Try to stay focused on your own situation, needs and dreams without worrying about what other people are doing. A lot can be said for the gratitude movement – focusing on your own successes and what you have in your life is the path to true joy. When you switch that focus to what others may have or be doing you take a detour that will not end well. The reality of other people's situations is not transparent so your desires and jealousies are not even based on the full picture. The family with two luxury cars and a large house may be deeply in debt. The woman who seems to have it all may be lonely while her husband works 90 hour weeks so they can have those material possessions. What are your values and goals? Those are the key questions you can use to direct your path.

17. **Put An End To Perfectionism.** Perfectionism is often the biggest roadblock we face. Too many people feel that if they can't deliver 100% with everything right and "just so", then they should abandon the idea completely. Learn to take one step at a time, build on things (skills, tasks, writing) and accept that it will never be perfect. It is important to look at growth over time and accept that putting something imperfect out there in the universe is better than staying safe and never attempting anything new.

18. **Look At The Evidence.** When you hear yourself saying you can't do something or are not good enough force your own hand and demand the evidence to back up the negative thoughts. Most of what you are thinking can be counter argued and disproved when you look at what you have done in the past, the feedback you received, etc. You may tell yourself you are not as good a blogger as someone else who is in the limelight, no one comments or cares about what you write. When you challenge that thought and look for evidence you see you do receive some comments and positive feedback. You may feel alone and like you are "never" included in social events, but when questioning this you admit you have been to a BBQ last month and had coffee with a friend last week. You may not be as busy as you wish, but you are actually included and can make the decision to organise a social event yourself.

19. **Redefine What Failure Means.** Fear of failing holds many of us back, especially high achievers who may be afraid to deviate from their comfort zones. If you go through life afraid to fail you often end up living a life where you never try anything new. When you re-define "fail" to mean "lessons learned" you can start to see how every step you take brings you closer to your dreams. When an idea or project fails to take off it offers you an opportunity to learn. What could you do differently? What did not work and why? Is there a better path for you to travel down?

20. **Stop Worrying About What “People” Think.** You will never please everyone so basing your decisions on what other people will think of what you do or say is an exercise in frustration. This is true whether it is business where you cannot have everyone as your target market or your personal life where your friends and family have their own ideas separate to your own. Most people are not even thinking about you and your actions on a day to day basis so why hand over power to them and let their potential reactions influence your actual actions.

CONCLUSION

21. Developing the right mindset is really crucial to succeed in anything. Work to make changes in the mindset areas that are acting as the roadblocks to your success.

LESSON PLAN : P 5
INTERPERSONAL RELATIONSHIP AND COMMUNICATION

Period	-	Two
Type	-	L/P
Code	-	P 3
Term	-	II (SD/SW)

Training Aids

1. Computer Slides, Charts, Marker Pens, Black Board, Chalk.

Time Plan

2.

(a)	Introduction	-	05 Min
(b)	Interpersonal Relationship	-	35 Min
(c)	Role of Communication in Interpersonal Relationship	-	35 Min
(d)	Conclusion	-	05 Min

3. A strong bond between two or more people refers to interpersonal relationship. Attraction between individuals brings them close to each other and eventually results in a strong interpersonal relationship. Communication is said to be the basis of every interpersonal relationship. Infact effective communication is the key to a healthy and long lasting relationship. If individuals do not communicate with each other effectively, problems are bound to come. Communication plays a pivotal role in reducing misunderstandings and eventually strengthens the bond among individuals. A relationship loses its charm if individuals do not express and reciprocate their feelings through various modes of communication. A healthy interaction is essential for a healthy relationship.

AIM

4. The aim of this class is to know about Interpersonal relationship and the role of communication in Interpersonal relationship.

PREVIEW

5. The class will be conducted in the following parts:-

(a)	Part I	-	Interpersonal Relationship.
(b)	Part II	-	Role of Communication in Interpersonal Relationship.

PART I : INTERPERSONAL RELATIONSHIP

6. **Forms of Interpersonal Relationship.** An interpersonal relationship can develop between any of the following:-

- (a) Individuals working together in the same organization.

- (b) People working in the same team.
- (c) Relationship between a man and a woman (Love, Marriage).
- (d) Relationship with immediate family members and relatives.
- (e) Relationship of a child with his parents.
- (f) Relationship between friends.

7. Relationship can also develop in a group. Relationship of students with their teacher, relationship of a religious guru with his disciples and so on.

8. **Must Have in an Interpersonal Relationship.**

- (a) Individuals in an interpersonal relationship must share common goals and objectives. They should have more or less similar interests and think on the same lines. It is always better if individuals come from similar backgrounds.
- (b) Individuals in an interpersonal relationship must respect each other's views and opinions. A sense of trust is important.
- (c) Individuals must be attached to each other for a healthy interpersonal relationship.
- (d) Transparency plays a pivotal role in interpersonal relationship. It is important for an individual to be honest and transparent.

9. **Interpersonal Relationship between a Man and a Woman.** A strong interpersonal relationship between a man and a woman leads to friendship, love and finally ends in marriage. A sense of commitment is essential in marriages and love affairs. Partners must feel attached to each other and most importantly trust each other. Famous psychologist Robert Sternberg proposed the triangular theory of love in interpersonal relationship. According to triangular theory of love following three components lay the foundation in love affairs and marriages.

- (a) Passion.
- (b) Intimacy.
- (c) Commitment.

10. The amount of love in any relationship is directly proportional to the above three components. More the three components, stronger the relationship is.

- (a) **Passion.** Passion refers to the physical and sexual attraction between two individuals. Individuals must feel physically attracted to each other for the charm to stay in relationship for a much longer period of time.
- (b) **Intimacy.** The amount of closeness between two individuals in a relationship refers to intimacy. Partners must gel with each other and a strong bond between them is essential.
- (c) **Commitment.** The decision of two individuals to stay together forever is called commitment. Commitment is nothing but two people deciding to be with each other life-long either by staying together or by entering the wedlock.

11. If any of the above factors is missing from a relationship, love fades away in a short span of time giving rise to troubles and sorrows.

12. **Relationship Between Friends.**

- (a) Friends must be honest to each other.
- (b) Stand by your friends at times of need.
- (c) Avoid leg pulling, criticism and making fun of your friends.
- (d) Try not to mix friendship with love as it creates problems and misunderstandings.

13. Interpersonal relationship between children and their parents, brother and sister, immediate family members or relatives revolve around trust, commitment and care.

PART II : ROLE OF COMMUNICATION IN INTERPERSONAL RELATIONSHIP

14. It is not always an individual needs to talk to express his /her feelings. Feelings can be expressed through non verbal modes of communication as well. Your body movements, gestures, facial expressions, hand movements communicate something or the other. Make sure you do not make faces at anyone. You should look happy and contented for the other person to enjoy your presence. Do not always look sad and irritated. Eye movements also have an important role to play in relationships. One can make out whether you are angry, unhappy or frustrated through your eyes only.

15. **Take Care Of Your Tone And Pitch.** Make sure you are not too loud or too soft. Being loud might hurt the other person. Speak softly in a convincing way. The other person must be able to understand what you intend to communicate.

16. **Choice of Words is Important in Relationships.** Think twice before you speak. Remember one wrong word can change the meaning of an entire conversation. The other person might misinterpret you and spoil the relationship. Be crisp. Express your feelings clearly. Do not try to confuse the other person. Being straightforward helps you in relationships.

17. **Interact Regularly.** An individual must interact with the other person regularly for the relationship to grow and reach to the next level. Speaking over the phone. SMSing are ways of communicating and staying in touch especially in long distance relationships where individuals hardly meet.

18. **Be Polite.** Never ever shout on your partner even if he has done something wrong. Discuss issues and try to sort out your differences amicably. Abusing, fighting, criticizing spoil the relationship and in adverse cases might end it as well. Being rude is a crime in relationships.

19. **Try To Understand The Other Person's Point Of View As Well.** Be a patient listener. Unless you listen carefully, you will never be able to communicate effectively.

20. **Individuals Can Also Communicate Through Emails.** If you do not get the time to call your partner regularly, drop him/her a mail. The other person would feel happy and important. Emails are also an effective mode of communication at workplace. For better relations at workplace, try to communicate through written modes of communication. Be careful about the mail body and make sure they are self explanatory. Using capital letters in emails is considered to be rude and loud. Do not share any information with any of your fellow workers verbally. Mark him a mail and do keep your Boss in the loop. All the related employees must be marked a cc as well. If discussed orally, the other person might refuse later on, creating problems for you.

CONCLUSION

21. Interpersonal relationship refers to a strong association between individuals sharing common interests and goals. A sense of trust, loyalty and commitment is essential in a relationship. Individuals need to trust and respect their partners to avoid misunderstandings and conflicts in relationship. Through communication in interpersonal relationship, people reach some understanding of each other, learn to like each other, influence one another, build trust, and learn more about themselves and how people perceive them. People who communicate effectively know how to interact with others flexibly, skillfully, and responsibly, but without sacrificing their own needs and integrity.

LESSON PLAN : P 6
COMMUNICATION SKILLS - 1

Period	-	Two
Type	-	L/P
Code	-	P 6
Term	-	I (SD/SW)

Training Aids

1. Computer Slides, Pointer, Charts, Black Board and Chalk.

Time Plan

2.	(a)	Introduction	-	10 Min
	(b)	Understanding Basics of Communication	-	20 Min
	(c)	Styles of Communication	-	20 Min
	(d)	Effective Communication	-	20 Min
	(e)	Conclusion	-	10 Min

INTRODUCTION

3. Communication is the exchange of information between people, e.g. by means of speaking, writing or by using a common system of signs or behavior. Man is a social animal, and communication is intrinsic to human nature.

4. Communication may be defined as “A process of sharing facts, ideas, opinions, thoughts and information through speech, writing, gestures or symbols between two or more persons”. It is something that is universal and happens all the time. We are communicating all the time with others. While you are reading this, we are trying to communicate to you.

AIM

5. To understand the basics of styles and ways communication and to effectively communicate with others in an effective manner.

PREVIEW

6. The class will be conducted in the following parts:-
 - (a) Part I - Understanding basics of Communication.
 - (b) Part II - Styles & Ways of Communication.
 - (c) Part III - Effective Communication.

PART I : UNDERSTANDING BASICS OF COMMUNICATION

7. Communication is conveying a message – verbally, written or through the use of signs. If we do not talk with others, then they will not know what we are thinking and they will not be able to understand us. One will feel terribly lonely this way. For some people, it is the problem of not knowing how to communicate. For others, it may be that they are too afraid to talk about their problems, share their views, and let others know what is going on in their mind. In fact, without communication, our relationships with others are likely to be dominated by suspicion, guesses, misunderstandings and false assumptions. Empathy creates wonderful results only when we are willing to let others know how we feel.

8. Lack of communication breeds problems in our relationships. We tend to assume that others know what we want or how we feel. Then when they do not react as we expect they should, we get upset. We are annoyed when others may not know why! We expect people to understand us. The truth is they do not understand us, if we choose to believe that ideas can get across at the unspoken level! All too often, the communication between us and our loved ones, is merely functional – out of necessity. We waste many opportunities to enhance our understanding of each other and improved our relationship.

9. For instance, if you are used to your mother cooking every day, and assume it is her role to cook so there is no need to feel special about it, she may increasingly find cooking a chore. Do you know each time your mother goes into the kitchen, she puts in her affection into the food by choosing the type of vegetables or ingredients you like? Do you know that each time she dishes out the food; she silently hopes you will enjoy it and tell her how good it was? She may be able to tell from the way you gobble up the dal bhat, but nothing is more powerful than language at that moment if you can simply say: “Mummy, it’s delicious, I love it!” You will make her day! You can do it every day to make her feel appreciated, even though it is not in your culture, or habit.

10. There are many such moments for us to express affection, especially to our family members. If you simply let those moments slip by, you will realize that the fountain will dry up one day. Relationship, like a reservoir, requires constant nourishment. Imagine what would happen to the reservoir if we keep drawing water from it but there was no rainfall to top it up. Similarly, we cannot draw affection without investing affection. By counting to take relationships for granted, we will come to a crisis one day – when the reservoir has dried up. That is how things begin to fall apart.

11. We often find people harbouring grudges against each other for being unhelpful, uncaring, not showing sufficient understanding. Any times we stop talking to people for long durations because of anger. This long silence is like a time bomb, which may explode one day at the slightest provocation. We all have a part to play in triggering its explosion. If you can reduce your part, you are helping to deaden the bomb. Long silence does not help to resolve problems. On the contrary, it breeds bitterness. When our heart is bitter, we cannot be happy and loving; even though we can suppress the bitterness to pretend we are fine. If you do not begin to make a change though, the silent relationship pattern will go on from generation to generation. It will stay the same with your parents, either your future wife or husband, and children of your own.

12. We all have fears, worries, and concerns; talking with somebody we trust is an effective way to relieve ourselves of mental stress. If we can share our inner world with others, we may realize that we are not alone – others have the same problems. That makes us feel instantly better.

PART II : STYLES & WAYS OF COMMUNICATION

13. There are three styles of communications as under:-

(a) **Aggressive.** They believe that everyone should like them; I am never wrong I’ve got rights but you don’t. They have a close mind and are poor listeners. They have

difficulty in seeing the other person point of view, they interrupt and monopolize. They tend to dominate and put down others. They are bossy. While communicating they frown, stare, talk loudly or have a yelling tone of voice.

(b) **Passive**. In such communication the persons do not express their true feelings; they do not disagree and think that others have more rights than they do. Their communication style is indirect, they always agree and do not speak out and are very hesitant. While communicating they often lack facial expression and stand with down cast eyes.

(c) **Assertive**. In such communication the person believes those he/she as well as others are valuable. They know that if they have rights then others also have rights. They are active listeners and check on others feelings. They are action oriented, attentive, vocal, expressive, good listeners, aware, supportive, persuasive, fair, open and consistent in behavior. Their expectations are realistic. They have open and natural gestures. They maintain an eye contact while communicating.

14. **Ways of Communication**.

(a) **One Way Communication**. Communication from a single channel. There is no opportunity for clarifying doubts. For example, Principal announces- Saturday is a working day and student can wear colored dresses.

(b) **Two Way Communication**. Communication between two channels. Opportunity for clarifying doubts. For example, parents deciding on the duration of the vacation to a hill station after discussion with the children.

PART III : EFFECTIVE COMMUNICATION

15. Effective Communication involves:-

(a) **Verbal Communication**. One person talks and others listens to be able to react. The conversation can be informative, in the form of questions, a negotiation, and statement or open ended questions, instruction, etc. And the situation can be formal or informal. In relationships, communication is usually informal. A speaker, to clear up misunderstand of what is said may ask questions to gain information and may repeat in a different way (paraphrase). Speech problem, too long sentences, mumbling, speaking too softly, hearing problems, listeners interrupting the speaker, loud external noises, etc. all hamper proper communication.

(b) **Non-Verbal Communication**. Non verbal communication is that gives meaning to what is said and may communicate both appreciation and rejection. It includes such things as tone of voice, a nod of head, using silence, frowning, smiling, body posture, touch, shaking of the head to communicate approval or disapproval, lifting of the eyebrows to show surprise, distance between persons, playing with something in hand instead of focusing etc. The body language communicates a lot in the communication process. Body language can be easy to read, but at the same time easy to misinterpret. It is not only important to observe the non-verbal communication of others and understand how well they receive or reject the communication, but also use proper body language to communicate effectively. Ensure that you appreciate others through body language. React to what others say by nodding, smiling and generally showing you are listening.

(c) **Listening**. During communication, one person talks and another person listens. The listeners must give attention to all that is said, without interrupting the speaker and react later in a relevant manner. Many people may listen but know what the full message is. Some people react to only half is said. There are people who listen "selectively", who miss much of the message and only focus on points relevant to him or her. Sometime we

do not listen to our friends and other people; sometimes they do not listen to us. In either situation, there will be a problem in communication and understanding.

16. How would we know if someone is not listening to us:-

- (a) Looks away.
- (b) Interrupts.
- (c) Looks at the watch.
- (d) Gets up to do something and returns.
- (e) Gives advice.
- (f) Talks to someone else.
- (g) Answers the phone.
- (h) Begins to do some work.
- (j) Does not stop doing work.
- (k) Says that she/he will be back in a minute and does not return.
- (l) Looks bored.

17. Components of Communication:-

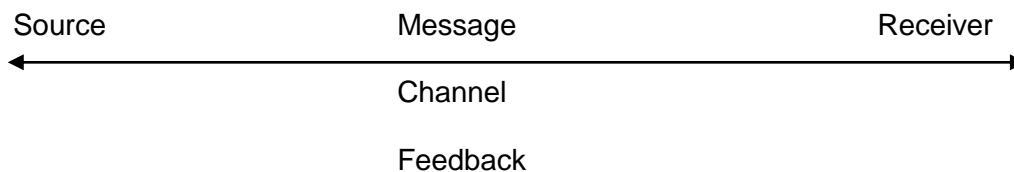

18. All the components must be present for effective communication.

19. **Why is Effective Communication Important to Young People?** Adolescence being a period of immense change, communication during this transitional phase of life assumes even more importance. Young people should be equipped to effectively communicate with others regarding their feelings and emotions or decisions. Also, a young person who is in need of advice or who harbours some fears, needs to talk to others and express himself/herself.

CONCLUSION

20. The ability to effectively communicate with other people is an important skill. Through communication, people reach some understanding of each other, learn to like each other, influence one another, build trust, and learn more about themselves and how people perceive them. People who communicate effectively know how to interact with others flexibly, skillfully, and responsibly, but without sacrificing their own needs and integrity.

LESSON PLAN : P 6
COMMUNICATION SKILLS - 2

Period	-	Two
Type	-	L/P
Code	-	P 6
Term	-	II (SD/SW)

Training Aids

1. Computer slides, Charts, Pointer, Black Board and Chalk.

Time Plan

2.

(a)	Introduction	-	05 Min
(b)	Common Barriers to Effective Communication	-	25 Min
(c)	Barriers of Communication	-	25 Min
(d)	Communicate Tactfully	-	20 Min
(e)	Conclusion	-	05 Min

INTRODUCTION

3. Overcoming the many barriers to communication is more a matter of common sense, practice and effort than any specific skill. Essentially, being an effective communicator means having the skill to recognize if and when there is a barrier to communication and being able to resolve it.

AIM

4. To understand the components and Barriers to Effective Communication and how to Communicate Tactfully.

PREVIEW

5. The class will be conducted in the following parts:-

(a)	Part I	-	Common Barriers to Effective Communication.
(b)	Part II	-	Barriers of Communication.
(c)	Part III	-	Communicate Tactfully.

PART I : COMMON BARRIERS TO EFFECTIVE COMMUNICATION

6. No matter how good and effective a communicator one maybe, yet the fact is that one does face certain barriers, from time to time, which forces them to work on becoming even more effective in their skills to communicate. Given here are the communication barriers that occur while listening, speaking and in the case of non- verbal communications.

7. **Listening Barriers.**

- (a) Interrupting the speaker.
- (b) Not maintaining eye contact with the speaker.
- (c) Rushing the speaker to complete what he has to say.
- (d) Making the speaker feel as though he is wasting the listener's time.
- (e) Being distracted by something that is not part of the ongoing communication.
- (f) Getting ahead of the speaker and completing his thoughts.
- (g) Ignoring the speaker's requests.
- (h) Topping the speaker's story with one's own set of examples.
- (j) Forgetting what is being discussed.

8. **Barriers While Speaking.**

- (a) Unclear message.
- (b) Lack of consistency in the communication process.
- (c) Incomplete sentences and mumbling words and sentences.
- (d) Not understanding the receiver.
- (e) Poor eye contact.

9. **The Other Barriers Include.**

- (a) Assumptions, for instance assuming others see a situation same as you or have same feelings as yours.
- (b) Patterns / reverting to type.
- (c) Language - different level of meaning.
- (d) Erroneous transition, value judgment.
- (f) Use of negative words.
- (g) Perceptions- depending on mood, the receiver may misinterpret the message.

PART II : BARRIERS OF COMMUNICATION**Barriers of Communication.**10. **Linguistic Barriers.**

- (a) Language/words.
- (b) Ambiguous words.

- (c) Lack of clarity.
- (d) Using technical terms.

11. **Psychological Barriers.**

- (a) Aggression.
- (b) Inferiority.
- (c) Symbol of status.
- (d) Hierarchy.
- (e) Memory.
- (f) Disinterest.

12. **Environmental Barriers.**

- (a) Disturbance/sound.
- (b) Environmental changes.
- (c) Lack of ventilation.
- (d) Lack of space.
- (e) Distance from participants.
- (f) Time.
- (g) Physical discomfort.

13. **Sender and Receiver Related.**

- (a) Depends on the mood (angry, happy, sad and depresses).
- (b) Personality type of sender or receiver (soft spoken, harsh with others, impatient, arrogant, not listening to others, cannot take orders, meek, docile, fear of authority etc.).
- (c) The level of trust one holds for the other person.
- (d) Perception about the other person.
- (e) Value judgment (not effective, clever, hard worker, lazy).
- (f) Lack of empathy (not bothering to understand the situation the other person is in).

14. **Content Related.**

- (a) Content chosen is sensitive.
- (b) Inappropriate for the receiver.
- (c) Incoherently communicated.

(d) Use of words (to complex expression, use of unknown language or words, hidden meaning etc.).

15. **Method Related.**

(a) Inappropriate method (e.g. use of written text messages with illiterate population).

(b) Loss in transmission (disturbance/noise).

Causes of Communication Gap

16. The factors that causes 'communication gap' are many. They include:-

(a) The hierarchy (not able to question higher authority for clarification).

(b) Conflict of interest (e.g. personal interest versus the parental expectations).

(c) The level of motivation that one holds. (e.g. I do not care, things can wait).

(d) Perception (e.g. nobody understands me).

(e) Psychological factors (e.g. fear of authority and power, anger about following rules).

(f) Stress (e.g. stress due to exams/work/personal pressure and hence misunderstand the communication).

Reducing the Communication Gap

17. The following steps will help in reducing the communication gap:-

(a) Plan ahead.

(b) Involve others to contribute to planning.

(c) Listen to the suggestions made by others.

(d) Speak with purpose and be specific.

(e) Justify your stand without upsetting others.

(f) Have sense of humour.

(g) Have empathy.

(h) Do not be judgmental.

(i) Do not underestimate the ability of others to contribute.

(k) Observe the body language or the non-verbal communication of others.

(l) Be transparent to inform others of the planned activities and get feedback.

(m) Make modification in the plan to suit the need.

(n) The words 'yes' and 'no' are very powerful. Learn to use them appropriately.

PART III : COMMUNICATE TACTFULLY

18. The ability to deal with others without offending, giving feedback without creating conflict, a keen sense for what is appropriate, this is the skill of tactfulness. If you see the value of being tactful the following suggestions will help.

19. **Always Communicate Tactfully.**

- (a) T - Think before you speak.
- (b) A - Assertive communication.
- (c) C - Clarity of thoughts and content.
- (d) T - Tone and pitch of voice.
- (f) F - Focus on interests, needs of the listener.
- (g) U - Uncover hidden feelings.
- (h) L - Listen for feedback.

CONCLUSION

20. Communication is a basic skill and forms the foundation of all relationships. The quality of communication often determines the quality of a relationship. We communicate to give information, express our feelings, solve problems/arguments/ conflicts, to show that we care, etc. Therefore understanding how to communicate and learning how to communicate effectively in different situations protects young people from risks and risky behavior.

LESSON PLAN : P 6
COMMUNICATION SKILLS - 3

Period	-	Two
Type	-	L/P
Code	-	P 6
Term	-	III (SD/SW)

Training Aids

1. Computer slides, pointer, black board, chalk, flipchart, marker pen, four short messages or four news clippings from newspapers (two easy and two difficult).

Time Plan

2.	(a)	Introduction	-	05 Min
	(b)	Non- Verbal Communication	-	35 Min
	(c)	Importance of Listening	-	35 Min
	(d)	Conclusion	-	05 Min

INTRODUCTION

3. When we interact with others, we continuously give and receive wordless signals. All of our nonverbal behaviors - the gestures we make, the way we sit, how fast or how loud we talk, how close we stand, how much eye contact we make - send strong messages. These messages don't stop when you stop speaking either. Even when you're silent, you're still communicating nonverbally.

4. Often at times, what comes out of our mouths and what we communicate through our body language are two totally different things. When faced with these mixed signals, the listener has to choose whether to believe your verbal or nonverbal message, and, in most cases, they're going to choose the nonverbal because it's a natural, unconscious language that broadcasts our true feelings and intentions in any given moment.

5. The way you listen, look, move, and react tells the other person whether or not you care, if you're being truthful, and how well you're listening. When your nonverbal signals match up with the words you're saying, they increase trust, clarity, and rapport. When they don't, they generate tension, mistrust, and confusion.

AIM

6. To understand the body language and communication gestures of non verbal communication and active listening skills.

PREVIEW

7. The class will be conducted in the following parts:-

- (a) Part I - Non- Verbal Communication.

- (b) Part II - Importance of Listening.

PART I : NON-VERBAL COMMUNICATION

8. **Non-Verbal Communication.** Nonverbal communication has been defined as communication without words. It includes apparent behaviors such as facial expressions, eyes, touching, and tone of voice, as well as less obvious messages such dress, postures and spatial distance between two or more people.
9. **We Communicate with Our Eyes.** Eyes express emotion and attitudes. A strong gaze may indicate dominance or aggression and a person with little eye contact is seen as submissive or shy.
10. **Communication with Facial Expression.** When we look at people we are not only looking at their eyes. Facial expression is the most important means of communicating non-verbally. By looking at a face we can say whether the person likes or dislikes, understands or not. Faces can communicate interest and involvement. It can also express emotional status ranging from happiness to despair.
11. **A Good Gesture.** Hand gestures are second in importance to facial expression in non-verbal communication. We do use normally to repeat, emphasize or even contradict our verbal messages:-
- (a) You wave and also say good-bye: This is an example of both verbal and non-verbal signals in daily use.
 - (b) A clenched fist with wide-open eyes and loud voice” Here the verbal and non-verbal components emphasize one another.
 - (c) She says she is all right but throws her hand in despair. Here, there is an element of contradiction between the verbal and non-verbal components.
12. **Appearance.** Appearances serve to differentiate between people: the old from the young, the formal from the informal, doctor to patient, the judge from the accused. Appearances convey message about social status, personally attitudes and emotional states. Personal appearance not only affects our own self-image but also our behaviour and the behaviour of the people around us. The style of dress, hair, cosmetics or jewellery provides the basis for the first and sometimes long lasting impressions. Appearances are often deceptive but we nevertheless depend on using the cue in our day-to-day interactions with people. The change or modification in your daily appearances changes the behavior of people towards you.
13. **Posture and Gait.** The way a person sits, stands and walk reflects his/her attitude towards himself/herself and his/her relationship to others. Posture can reveal warmth, harmony with others and the status and power in relation to others. People unconsciously adopt different postures to those they like and dislike. People with higher status are relaxed in the presence of juniors who maintain formal postures.
14. When we interact with people whom we like, we tend to lean forward. When somebody whom we don't like interacts with us we tend to lean back to distance ourselves. A person walking slowly with hunched shoulders may be thought of as timid, whereas a straight back and purposefully gait may convey confidence. Sometimes we may be deceived by such inferences, but more often we are proved right. Each individual has his own characteristic style of postures and gait, which reflect their personalities and self-image.
15. **Proximity and Touch.** The distance that we maintain while communicating with others is indicative of how close we are. For example, we may hug a relative or a friend but we move away if an unknown person is standing too close to us.

PART II : IMPORTANCE OF LISTENING

16. Listening is one of the most important parts of developing good communication skills. Teaching students to listen well, in addition to speaking and writing, will help them develop holistic communication skills they can use in school and beyond. Listening well not only encourages the speaker, it helps the listener process the information they are hearing more effectively, allowing them to have discussions and provide quality feedback.

17. **Activity-I.** Write a statement on a paper (e.g.- Today is my brother's birthday and my mother will make dosa, cake, fruit chat and lassi). Ask the participants to sit in a circle. Give the statement to one participant and ask him/her to read silently. Then ask him/her to whisper the statement into the ear of the person sitting on his/her right. The message is passed on until it reaches back to the person who started it. The first and the last person speaks out the sentence. It is usually distorted beyond recognition. Try to figure out where the message got really distorted. For a few minutes the group should discuss the word that got distorted and the point at which the message got muddled. Explain that in real life, messages get distorted due to the way people perceive the meaning of the message, the way it is communicated and the way the receiver is allowed to process the message.

18. **Characteristics of Good and Effective Listener.** Good and effective listener tries to give maximum amount of thought to the speaker's ideas being communicated, leaving a minimum amount of time for mental exercises to go off track. A good listener:-

(a) **Is Attentive.** Good listener must pay attention to the key points. He/she should be alert. He/she should avoid any kind of distraction.

(b) **Do Not Assume.** Good listener does not ignore the information he/she considers is unnecessary. He/she should always summarize the speaker's ideas so that there is no misunderstanding of thoughts of speakers. He/she avoids premature judgments about the speaker's message.

(c) **Listen for Feelings and Facts.** Good listener deliberately listens for the feelings of the speaker. He/she concentrates totally on the facts. He/she evaluates the facts objectively. His listening is sympathetic, active and alert. He/she keenly observes the gestures, facial expression and body language of the speaker. In short, a good listener should be projective (i.e. one who tries to understand the views of the speaker) and empathic (i.e. one who concentrates not only on the surface meaning of the message but tries to probe the feelings and emotions of the speaker).

19. **Concentrate on the Other Speakers Kindly and Generously.** A good listener makes deliberate efforts to give a chance to other speakers also to express their thoughts and views. He/she tries to learn from every speaker. He/she evaluates the speaker's ideas in spare time. He/she focuses on the content of the speaker's message and not on the speaker's personality and looks.

20. **Opportunities.** A good listener tries to take benefit from the opportunities arising. He/she asks "What's in it for me?"

CONCLUSION

21. To conclude, if you want to become a better communicator, it's important to become more sensitive not only to the body language and nonverbal cues of others, but also to your own. Effective listening enhances the communication quality. It makes all attentive. It encourages optimistic attitude, healthy relations and more participation. It leads to better decision-making in an organization.

LESSON PLAN : P 7
LEADERSHIP TRAITS

Period	-	One
Type	-	L/P
Code	-	P 7
Term	-	I (SD/SW)

Training Aids

1. Computer Slides, Charts, Pointer, Black Board And Chalk.

Time Plan

2.	(a)	Introduction	-	05 Min
	(b)	Important Leadership Traits	-	20 Min
	(c)	Other useful Traits	-	10 Min
	(d)	Conclusion	-	05 Min

INTRODUCTION

3. In the past much of leadership training had centered around life studies of some eminent military figures. This historic approach, which was later reinforced by an extensive survey conducted after World War II taught that there are some common traits in the lives and careers of all successful leaders. Fourteen traits were found to be common amongst eminent leaders of the past.

4. It is common knowledge that there indeed are certain traits which are necessary in leadership. For instance it is inconceivable that a leader can function without some of those traits like enthusiasm, judgment and knowledge. For teaching leadership at junior level the "Trait Approach" continues to be the most effective method available and is of importance to the Armed Forces.

5. Leadership traits are human qualities that are of great value to a leader. Possession of these traits simplifies the task of applying the leadership principles and assists greatly in winning the confidence, respect and cooperation of other men. Individuals possess these traits in different degree according to the constitution of their character. These cause variation in the type of leadership exercised by individuals and make leadership a personal function. An individual can benefit by studying the traits considered important to a leader. But with careful self-analysis and application, he can develop those traits in which he is deficient and further strengthen those in which he is strong.

AIM

6. To acquaint the class the importance of Leadership Traits and other Useful traits.

PREVIEW

7. The class will be conducted in the following parts:-
 - (a) Part I - Important Leadership Traits.

- (b) Part II - Other Useful Traits.

PART I : IMPORTANT LEADERSHIP TRAITS

8. A study of great military leaders reveals that none possessed all the leadership traits in the maximum degree but their weakness in one trait was compensated by the strength in the other. A good leader will capitalize on his strong traits and at the same time take steps to improve his weak traits. It would, however, be recognized that the leader's goal, the personalities of the people with whom he is working and the circumstances of the specific situation, all will have a profound effect on which particular trait needs most emphasis. Traits that are of paramount importance to a leader are given below:-

(a) **Alertness**. In battle a Commander is offered fleeting opportunities by the enemy, which if seized and exploited can bring decisive victories to his force. Alertness of mind is what helps a Commander to pick up these opportunities at the right time and exploit the situation to his own advantage.

(b) **Bearing**. Denotes desirable physical appearance, dress and deportment. A leader and more so an officer should, therefore remember that his personal bearing will exercise a dominating and permeating influence not only with his own men but with the general public too. In public therefore, as on parade, he must conduct himself in such a fashion that the uniform he wears is regarded by the general public not merely as a uniform but as the hall mark of a great profession of arms to which he belongs; a profession whose prestige in times of war is virtually bound with a nation's destiny.

(c) **Courage**. Courage is a mental state. It gets its strength from spiritual and intellectual sources. The way in which these spiritual and intellectual elements are blended, produces roughly two types of courage. The first is emotional state which urges a man to risk injury or death is physical courage. The second, a more reasoning attitude which enable him coolly to stake career, happiness, his whole future on his judgment of what he thinks either right or worthwhile is morale courage. A leader must possess both forms of courage.

(d) **Decisiveness**. A logical thought process is essential for solving a problem or making a plan. Thereafter the leader's intention and his proposed method of execution must be made perfectly clear to all taking part. He must therefore acquire the ability to make decisions promptly when required and announce them authoritatively, concisely and clearly. The leader's power of decision results from his ability to remain unperturbed in a crisis. His greatest assets are the ability to think rationally when his men have ceased to think, to be decisive in action when they are paralyzed by fear.

(e) **Dependability**. You cannot get very far in any sphere of activity without reliability. Set yourself high standards both for the amount of work you get through and the quality of work irrespective of supervision. Make a practice of carrying out all instructions and plans of your superiors to the best of your ability, and always on time. Always be ready to help out in an emergency even if it interferes considerably with your personal conveniences. 'Business before self' should be the rule. Whatever has to be done, take it in your stride, and never allow yourself to appear moody. Dependability has to be built up slowly by deliberate effort. It can be lost overnight if not guarded jealously.

(f) **Endurance**. A time comes in battle when both the opposing forces feel that probably they are fighting a losing battle. It is a time when battles are won or lost. The side which has that little extra endurance wins. It is the leader who has that extra endurance both of mind and body that can inspire his troops to produce that extra endurance required to win battle or accomplish the assigned task. Mental and physical endurance are complementary. The old adage "A healthy body – a healthy mind" still holds good and both are essential for a leader.

(g) **Enthusiasm**. It is the display of genuine interest and zeal in the performance of duties. Enthusiasm comes from liking your job, having a living interest in all facets of your

work and seeing the possibilities for development of new ideas and techniques. However humdrum an occupation may seem to some people there is nearly always some feature in it which inspires the imagination. Jobs only appear dull, routine or mechanical when they are looked at with dull eyes and a dull mind.

(h) **Initiative**. Initiative is the willingness to act or offer well considered recommendations in the absence of orders. It should always be done right away what you might have done later. In other words initiative means one should not wait for things to happen but one has the ability to see quickly what needs to be done, making up ones mind to do it and accomplishing it. When a choice between two courses is available, one cautious and other bold and daring, the trait required is daring initiative.

(j) **Integrity**. As a leader one has to be honest, not only to oneself but with the men one leads and the people with whom one works. Honesty and integrity are absolute qualities that one cannot compromise or alter. Any loss or weakness in moral character will result in losing the confidence of our superiors, contemporaries and subordinates.

(k) **Judgment**. This is the power of the mind to assess various factors and values quickly and often under difficult circumstances and arrive at a wise decision. It is learned by experience and practice. At times a mistake or error of judgment may result, but it is more positive to learn from the mistake or error, rather than fight for exercising the power of judgment.

(l) **Justice**. The quality of being impartial and consistent in exercising command. Dispense justice quickly. "Justice delayed is justice denied".

(m) **Knowledge**. A leader must know more than the men he commands. Until he does, he has no business to be called their leader. The profession of arms requires a great deal of study, practice and experience not only of military hardware, organization, tactics and battle drills and procedures but more importantly of characteristics and capabilities of the men he leads. The process of acquiring knowledge never ends. There is always something new to learn even from re-reading or re-thinking of the same material or problem.

(n) **Loyalty**. The quality of being faithful to the country, the army, the unit, subordinates, colleagues and superiors. It is given by subordinates to a leader, in the manner in which the leader gives the same to them and to his own leaders. A leader must never take shelter behind the shortcomings or mistakes of his subordinates. When plans for which he is responsible go wrong he must take the blame, correcting the mistakes of subordinates himself. Every leader has the right to express his views to his superiors on any question under consideration but once a decision has been reached, he must act on it as if it were his own decision.

(o) **Sense of Humour**. The ability to appreciate the many amusing or lighter moments in everyday, life especially those which pertain to the leader himself. It is also the ability to remain cheerful under stress. At times when things go wrong in battle and tensions mount, humour if it comes naturally at the appropriate time can go a long way in defusing a situation or raising sagging spirits. This together with a sense of balanced optimism, are useful traits to develop. However, attempts at artificial coarseness and sarcasm do more harm than good.

PART II : OTHER USEFUL TRAITS

9. Some other traits though not described are important and are listed below:-

- (a) Truthfulness.
- (b) Esprit-de-corps.
- (c) Unselfishness.

- (d) Humility and sympathy.
- (e) Tact without loss of moral courage.
- (f) Patience and a sense of urgency as appropriate.
- (g) Self-confidence.
- (h) Maturity.
- (j) Mental including emotional stability.

CONCLUSION

10. In battle there is no substitute for good, sound and robust leadership. What needs attention is the cultivation of these qualities and their application. Essentially a leader must gain and keep whatever the circumstances, the respect and confidence of his troops so that they willingly accomplish the mission. Leadership is a mixture of personal example, persuasion and compulsion. It is by discipline that an Army is welded into a fighting machine, it is by leadership that the men and machines are led to victory.

LESSON PLAN : P 8
TYPES OF LEADERSHIP

Period	-	One
Type	-	Lec
Code	-	P 8
Term	-	I (SD/SW)

Training Aids

1. Computer Slides, Charts, Pointer, Black Board And Chalk.

Time Plan

2.
 - (a) Introduction - 05 Min
 - (b) Types of Leadership Style - 15 Min
 - (c) Range of Leadership Styles - 10 Min
 - (d) Two Dimensional Leadership - 05 Min
 - (e) Conclusion - 05 Min

INTROUCTION

3. We have already learnt about the 'Trait Theory' concept. Traits are human qualities that are of great value to the leader in winning the confidence, respect and coop of men. However, a uniform style of leadership cannot be effective at all times as the goals and the people with whom the leader has to wk will be different at different times. An effective leader, must therefore be able to carry his style of leadership if he is to get the best out of his men.

4. Leadership involves accomplishing the task with and through men under command. The need to accomplish his task should not blind him from the imp of his relationship with the men. Style of leadership refers to the manner and techniques employed to accomplish the task. This will draw comment, debate, argument and attn from subordinates, equals and superiors. The popular belief that all mil leaders are stereotyped holds no validity when a comparison is made of the personalities of successful leaders of the past.

AIM

5. The acquaint the cadets about the various Types of Leadership Styles.

PREVIEW.

6. The class will be conducted in the following parts:-
 - (a) Part I - Types of Leadership Style.
 - (b) Part II - Range of Leadership Styles.
 - (c) Part III - Two Dimensional Leadership.

PART I : TYPES OF LEADERSHIP STYLES

7. Basically there are two styles of leadership. It must however be realised that there is a wide range of styles between the two extremes, the autocratic and democratic.
8. **Autocratic Style of Leadership.** The traditional autocratic style implies the total concern for mission accomplishment with little or no concern for human relations. It is based on the assumption that a leader derives power from the position he holds.
9. A military leader holds an appointment position in a formal organisation. The accountability for decisions and subsequent actions within his unit or command rests entirely with him. The higher officers in the organisation use a highly centralised and autocratic style of leadership for making decisions and seldom consult subordinates. They rely primarily on their own ability and experience.
10. The men you will command are neither lazy nor unreliable. They are loyal and hard working. Win their confidence and they will lay down their lives for you.
11. **Democratic Style of Leadership.** This is also known as non directive style. This stresses the concern for human relationships. In this style of leadership, you share your responsibilities with your subordinates by involving them in both the planning and execution of tasks. This style assumes that the real power of a leader is granted by the group he leads. This style also assumes that people can be basically self directed and creative at wk if properly motivated. Democratic style encourages group discussion and decisions are arrived through consensus.
12. If you delegate much of auth for decisions making and exec to your subordinates and invariably consult the views of subordinates before making key decisions, your style of leadership will be democratic.
13. To a large extent, the persuasive leader bases his skill in leadership upon his personal examples and ability.

PART II : RANGE OF LEADERS STYLES

14. There are, of course, a wide variety of styles of leadership between the two extremes of Autocratic and Democratic. An effective leader should be able to vary his style to meet the demand of the sit.
15. Studies conducted on autocratic and democratic styles have revealed results as under:-
- (a) The group reacted favourably towards democratic leadership, by displaying enjoyment, constructive wk, and by continuing to function effectively even when the leader was not physically present on the scene of action.
 - (b) The autocratically led group on the other hand, displayed more hostility, aggression, lower morale and tended to fall apart during the leader's absence.
 - (c) The quality and qty of wk under the autocratic leader was better than it was under the democratic leader. Also the autocratic leader gets his job done speedily.
16. In essence, these studies reveal that a democratic style of leadership is gen more desirable than an autocratic one, in certain types of sits. However, in certain sits, the autocratic style has its advantages viz when adequate time is NA to accomplish msn or when the subordinates are not mature enough. An effective leaders should vary his style as per the demands of the situation and people.

17. **Which is the Best Style.** The question of whether a leader should be exacting or easy on his subordinates has no simple answer. A democratic leader can be a hard task master at times. Similarly, an autocratic leader may by fatherly fig revealing fairness and consideration when the occasion demands. What is important is that one must be aware of the variety of styles and select the appropriate one depending on the nature of the msn, time available and the men under command.

PART III : TWO DIMENSIONAL LEADERSHIP MODEL

18. Traditional mil leadership is taught to lay more or less equal emphasis on mission accomplishment and concern for men. At times, especially under the stress of comb, these two conflict each other and the leader faces the question - which is more imp. Some leaders emphasize mission accomplishment while others concentrate on welfare.

19. The square thus formed can be separated into four quadrants which is prepared as of leadership and styles. eg, a leader who is strictly msn oriented w/o concern for men would be op in the lower right quadrant of high msn accomplishment and low concern for men. On the other hand, the leader who stresses concern for men and slights msn accomplishment would be operating in upper left quadrant. However, the most desirable type of leadership style is represented in the right hand upper quadrant (high mission accomplishment and high concern for men), and the most ineffective style is represented by the left hand lower quadrant wherein leader neither cares for mission nor for men.

CONCLUSION

20. The trait principle concept gives us an insight into our behaviour and by knowing it we can cash on the strong pt. Since in the Army we are basically concerned both with msn accomplishment and welfare of men under our command, we must be aware of our style of leadership. It is not always possible to equally bal the two needs, yet we can learn to reach one through the other. eg, the concern for men during peace can pay us rich dividend for accomplishing the mission during war.

LESSON PLAN : P 9
ATTITUDE – ASSERTIVENESS AND NEGOTIATION

Period	-	Two
Type	-	Lec
Code	-	P 9
Term	-	III (SD/SW)

Training Aids

1. Computer Slides, Charts, Pointer, Black Board and Chalk.

Time Plan

2. (a) Introduction - 05 Min
- (b) Types of Attitude - 35 Min
- (c) Assertiveness & Negotiation - 35 Min
- (d) Conclusion - 05 Min

INTRODUCTION

3. An attitude is an expression of favor or disfavor toward a person, place, thing, or event. Prominent psychologist Gordon Allport once described attitudes "the most distinctive and indispensable concept in contemporary social psychology. Essentially, what you think, what you do, and what you feel is what forms your attitude. ". Attitude can be formed from a person's past and present. over the years by various means. Sometimes, they are based on our experiences and knowledge and sometimes we acquire them from other people. Sometimes they are based on what is true or what we think is true. Humans manifest their attitudes through their behavior and actions.

AIM

4. The aim is acquaint cadets about Attitude.

PERVIEW

5. The lecture will be conducted in following parts:-
 - (a) Part I - Types of Attitude
 - (b) Part II - Attitude - Assertiveness and Negotiation.

PART I : TYPES OF ATTITUDE

6. **Definition.** An attitude can be defined as a positive or negative evaluation of people, objects, event, activities, ideas, or just about anything in your environment, but there is no precise definition.

7. Components of Attitudes.

(a) **Cognitive Component.** It is the belief segment of an attitude. When someone forms an opinion or perception about any person, object, or situation; the cognitive component comes into play. The opinion may be favorable or unfavorable, positive or negative. For example, if a person says "Life is unfair", he's iterating his opinion about how he perceives life is.

(b) **Affective Component.** It is the feeling segment of an attitude. When someone attaches his/her emotions to the opinion that has been formed about any person, object, or situation; the affective component comes into play. For example, if a person says "I hate the fact that life is unfair", he's connecting an emotion through hatred, to his opinion of life being unfair.

(c) **Behavioral Component.** As the word itself suggests, it's the behavior segment of an attitude. When a person attaches a desire to behave or act in a certain way, based on the emotions he has attached to the opinion about any person, object, or situation; the behavioral component comes into play. For example, if a person says "I am going to hurt myself and others, if life doesn't stop being unfair to me", he's reflecting a desire to act by hurting himself and others, based on how he perceives life to be and the emotions he has attached to this perception. However, a negative attitude need not be always concluded through a negative reaction. Instead of stating "I am going to hurt myself and others if life doesn't stop being unfair to me", he could have said "The change needs to start from within myself if I am to make it fair". It is in our own hands of how we transform the negative attitude into positive.

8. **Types of Attitudes.** Attitude is something that lies between emotions and thought processing. In the broader sense of the word there are only three attitudes, a positive attitude, a negative attitude, and a neutral attitude. If someone has good feelings about something e.g. towards his/her work, or people, then it is positive attitude otherwise it would be negative. There could also be some other types of attitude. These are:-

(a) **Positive Attitude.** The predisposition that results in desirable outcomes for individuals and organizations can be described as positive attitude. When an individual has a positive attitude, it helps him cope with daily affairs of life very easily, and make right and strong decisions. There are many results of this positive like creative thinking, positive thinking, motivational drive to achieve goals, success, constructive mind set, seeking opportunities, easy thought process of solving problems, and a stress free life.

(b) **Negative Attitude.** The tendency of a person that results in an undesirable outcome for individuals and organizations can be described as negative attitude. Negative attitudes are punished in order to discourage the same action in future.

(c) **Neutral Attitude.** The tendency to remain non committal or neutral.

(d) **Rebellious Attitude.** A rebellious attitude is a commonly found negative type of attitude. People who have this attitude towards objects, are often in disagreement with most situations, people and other things around them. In a rebellious attitude, a person only thinks defensively towards most things, and reacts in very aggressive pattern like, bold actions, loud voices, high energy breakouts, etc. These can be harmful for people around him, as well as himself. Anger, depression, loneliness, despair, disagreement, defensiveness, are a few more repercussions of this negative attitude.

(e) **Rational and Irrational Attitudes.** This carries shades of positive or negative attitudes which a person develops with or without full or complete knowledge.

(f) **Individual and Social Attitudes.** These are those traits of attitudes which a person displays to himself or towards a social group.

9. **Kinds of Attitude.** Given below is a list of attitudes that are expressed by people, and are more than personality traits, which you may have heard of, know of, or might be even carrying them:-

Acceptance	Confidence	Seriousness	Optimism	Pessimism	Interest
Independent	Jealous	Courteous	Cooperative	Considerate	Gratitude
Cheerful	Inferiority	Happiness	Frankness	Respectful	Condescending
Authority	Sincerity	Persistent	Honest	Sincere	Sympathetic
Responsible	Realistic	Faithful	Flexible	Decisive	Trusting
Thoughtful	Determined	Loving	Satisfaction	Hostile	Generous
Modest	Reliable	Tolerant	Kind	Humble	Cautious
Suspicious	Sarcasm	Helping	Hardworking	Inclusiveness	Tenacity

PART II : ASSERTIVENESS AND NEGOTIATION

Assertiveness

10. Assertion can give a person that special edge, which enforces success and prosperity, be it in personal life or professional. Assertiveness or assertive attitude implies to a positive attitude. It refers to dealing with situations in an optimistic, confident and self-assured manner. An Assertive attitude has innumerable incentives. A positive belief in yourself and ideas will mesmerize others to believe in you. People are usually in awe of individuals with assertive attitudes. Ideas, views and opinions of such individuals are widely accepted with ease. They have the perks of getting what they want. An assertive attitude is a not a natural essence. It is something that one needs to develop and adopt with time & experiences as many of us have faced withdrawals, insecurities & domination during our juvenile years.

11. **How to Develop Assertiveness.**

(a) **Experiment and Try New Things.** It is said that variety is the spice of life and indeed it is. Try new things. Indulge in activities you have never done before. Experience the inexperienced. Take a plunge. Just a little adventure can make you feel brand new and invoke a lot more self-confidence.

(b) **Extend Your Social Circle.** Go out and socialize. Meet new people and make new friends. Socializing will help you feel a little more assertive about yourself. Meet friends and make new friends with known acquaintances. Socializing will not only help you develop an assertive attitude but also help you learn a lot from others!

(c) **Learn to Make Decisions for Yourself.** If you have always taken others advices then it's time to get rid of this habit. Take responsibility for your actions and take decisions for yourself. Believe in yourself and your instincts instead of being slave to others opinion!

(d) **Indulge in Knowledge.** Learning is a never-ending process and knowledge has no bounds. Learning and acquiring knowledge will never go futile. Its knowledge that proves to be the savior in tough times. Learning gives you a new belief, a new confidence in yourself. A new art or talent knowledge will help you explore your options & forte as well as make you feel positive about yourself.

(e) **Admire Yourself & Others.** Remember no one will respect & listen to you if you don't respect and believe in yourself. Self-love should be your first love. However, it's always nice to admire others the way they are. It generates a positive environment which is quite expedient for developing an Assertive Attitude.

Negotiation

12. Your attitude and behavior can affect the outcome of many encounters in your life, including negotiations. When negotiating anything, from a positive response from a member of your fitness facility to revising and renewing a maintenance contract, a win-win philosophy is most profitable. A successful negotiation process results in both sides feeling like they have gained something for their efforts. Objectives, strategies and tactics are only part of the negotiation game. Your attitude and behavior may give you more confidence at the negotiation table. Some points to observe are:-

- (a) **Be Sensitive to The Needs Others.** Being empathetic can gain the respect of others and forge a long-term business relationship with the other party. Empathy implies that you are trying to see the needs, wants and desires through the eyes the other person.
- (b) **Be Willing To Compromise.** A rigid position will leave closed to creative ideas. In a win-win situation, the words negotiation and comprise are synonymous.
- (c) **Develop Your Creative Problem-Solving Skills.** Practice the following brainstorming technique: Pick a problem to solve; then list all the solutions that enter your mind within a three-minute period (no ideas are judged at this point). Work from your list to decide on and fine tune a solution. Don't be afraid to voice an idea that is unusual. Your unusual idea may turn out to be the best solution to the problem.
- (d) **Learn to Welcome Conflict.** Conflict is a natural part of the negotiation process. Brush up on your conflict management skills by role-playing conflict situations with friends and co-workers. The practice in handling difficult situations may give you more confidence at the negotiation table.
- (e) **Practice Patience.** Losing your temper is a sign that you are losing your win-win attitude. Take a break to regain your focus if you find yourself becoming aggravated.
- (f) **Increase Your Tolerance For Stress.** Negotiating can be intimidating and stressful. A manager of a pro shop shared the story of a staffer who was treated gruffly by a vendor with whom he had been cordial. The manager expressed surprise at the staffer's pleasant response when treated with such rudeness. The staff member replied kindly, "Why should I let his actions determine my behavior?"
- (g) **Improve Your Listening Skills.** Paraphrase what the other party is saying to avoid misunderstandings. The more you listen, the more you will understand and eventually you will be understood.
- (h) **Learn To Identify Bottom-Line Issues Quickly.** Do your homework prior to the negotiation meeting to ensure you know the value of each issue. A winner knows how much they have to learn even when they are considered an expert. A loser wants to be considered an expert by others, before they have even learned enough to know how little they know.
- (j) **Be Assertive, Not Aggressive.** Use a confident, persuasive tone for best results. The danger in acting aggressively is that the harder you push, the harder the other party will push back. If you are trying to make a big splash, then you are probably the one who has gone overboard.

CONCLUSION

13. What we think, what we do, and what we feel is what forms our attitude. While sometimes knowledge and experience form our attitude, on other occasions it is based on our assumptions and beliefs. It is possible for a human beings to change or unlearn their attitudes as attitudes are

learned. One needs to change the way he or she thinks, behaves, and feels in order to change the attitude. We must always strive to imbibe or create a positive attitude. An assertive attitude could play a pivotal role in success. Assertion can indeed, make it or break it. Remember every task or situation begins with an idea & its execution lies in a positive or assertive belief. Develop an Assertive attitude if you wish to achieve success with ease.

LESSON PLAN : P 10
TIME MANAGEMENT

Period	-	Two
Type	-	Lec
Code	-	P 10
Term	-	I / II (SD/SW)

Training Aids

1. Computer Slides, Pointer, Charts, Black Board and Chalk.

Time Plan

2.	(a)	Introduction	-	05 Min
	(b)	Time Management and Time Wasters	-	35 Min
	(c)	Principles of Time Management	-	35 Min
	(d)	Conclusion	-	05 Min

INTRODUCTION

**“We all have one thing in common — a 24 hour day.
It is how we use our time that makes the difference.”**

3. What is time? As far as we know, animals do not experience it. Tempus fugit – Time flies – is a universal refrain. But what is time? We all know what we mean by time but we cannot say what it is. If you are traveling at a speed faster than another person, time will go slower for you. The nearest we can come to grasping the concept of time is, to look upon it as a dimension. Being human, we tend to measure time and change in terms of our life span. As we advance in life, we acquire a keener sense of the value of time. For a very old person sitting in hospital waiting to go home, time can seem like eternity. Yet for such a person, paradoxically, there may be only days or hours of time left.

4. Time is your most important asset, because it is the only one you can't reorder or renew. Time it is irreplaceable and irreversible. Few things are more important to us than learning how to save time and how to spend it wisely. Paradoxically, to save time you must spend time. Both time and money are limited resources. Therefore time (like money) is a valuable commodity. It cannot be borrowed, saved or squandered. Time is patently not money. You can make money; you can't make time.

5. An old Chinese proverb says 'An inch of gold cannot buy an inch of time.' Time is really infinitely more precious than money.

AIM

6. To acquaint the class with the importance aspects of time management and its principles.

PREVIEW

7. The class will be conducted in the following parts:-
- (a) Part I - Time Management.
 - (b) Part II - Time-Wasters.
 - (c) Part III - Principles of Time Management.

PART I : TIME MANAGEMENT

8. Time management is a set of skills, tools, and systems that work together to help you get more value out of your time and use it to accomplish what you want. Successful people use time management to achieve outstanding results, both personally and professionally. The key to time management is to realize that you cannot possibly do everything that there is to do; instead, you have to consciously decide what *you* are going to do with the limited amount of time that you have at your disposal. Look in a mirror and you will see your biggest time waster. Until you come to grips with that reality, few if any of your personal time problems will be overcome.

9. Time management helps you to: -
- (a) Reduce or eliminate wasted time and effort so you'll have more productive time each day.
 - (b) Improve your productivity so you can accomplish more with less effort.
 - (c) Focus your time and energy on what is most important & make time for the things you want and value. Thus help you find greater balance and fulfillment.
 - (d) Improve your performance while reducing stress.
 - (e) Set and achieve your long-term goals.

PART II : TIME WASTERS

10. Time is like a precious jewel. It must be guarded well and worn with discretion or you will suddenly realize that it has been stolen. Major time-wasters are:-

- (a) **Telephone**. Learn to control the telephone, or it will control you. Regard your telephone as a business tool, not a social one. Practice having quick, to the point conversations.
- (b) **Visitors**. Meet visitors outside. When faced with the question: 'Have you got a minute?' don't fall into the courtesy trap of saying yes when you really want to say no. Learn to give a polite no, and then tell them when they can see you. A complete open-door policy, which has been a popular management technique for some years, is not conducive to good time management. Managers to have at least one or two hours in the day when they can work without interruption. Try some of these techniques if a visitor overstays their time:-
 - (i) At the finish of business, stand up.
 - (ii) Let the visitor see you looking at your watch.

(iii) Don't make eye contact with the chatty one. Keep your head down and continue working.

(c) **Paper.** The best guideline for paperwork is to either file it or toss it. We never use 80% of the paperwork we keep. Computer printers produce over two and a half million pieces of paper every minute throughout the world.

(i) Try, where possible, to make a decision about each piece of paper when you first handle it.

(ii) Don't handle your daily mail until you are ready to deal with it properly. If you take a quick look and then go back to it later, you've just doubled those minutes. Every time you handle something again you increase your distraction time. Can some of it be passed on to others?

(iii) Learn to read selectively.

(iv) Learn to throw out what you probably won't need.

(d) **Lack of Planning & Fire Fighting.** The best way to avoid crises is to anticipate them. Common reasons are lack of planning, unrealistic time frames, and reluctance by subordinates to break bad news. Tips to help you deal with the situation:-

(i) Firstly, take time to think. Then ask questions. What is the real problem? Where possible, get input from more than one source. What can you ask others to help with?

(ii) Once you've made a decision, get on with it. Whoever hesitates is lost!

(iii) What can be done to avoid the same problem happening again?

(e) **Socializing.** Avoid extended tea-breaks, regular social lunch-hours, and lots of chats in the corridors. Do it outside of work time.

(f) **Indecision.** Caused by ignorance, fear, or lack of confidence in the facts. Improve your fact-finding procedures, and learn to listen to your intuition. If we can learn to make decisions quickly, we save time. Successful people make decisions quickly. They're not necessarily always right, but they do decide.

(g) **TV.** Can be a huge time-waster.

(h) **Procrastination.** Procrastination, which comes from the Latin word for 'tomorrow' is the world's number one time-waster. Procrastination can best be defined as putting off the doing of something that should be done – intentionally & habitually. If you suspect that you are prone to procrastination always ask yourself "Why am I putting this off? " If you can see no good reason – and don't confuse reasons with excuses – brace yourself and take action this day. By off-loading today's work onto tomorrow you are simply storing up work for yourself. Start now by doing something today that you have been putting off. It may be a small or large matter; an overdue apology; a meeting with your boss; or an unpleasant task you know you should tackle.

11. The best tool to fight time-wasters is a firm decision to concentrate on the few things that, in a day, will make a long-term difference. People and opportunities waiting to waste our time, surround us. Any activity which is not, in some way, moving you in the direction you wish to go, is a time-wasting activity.

PART III : PRINCIPLES OF TIME MANAGEMENT

12. There are 10 basic principles of time management. These are given in the subsequent paras.

13. **Develop a Personal Sense of Time.** “Make sure you know where your time goes. Don’t depend on memory, it’s treacherous”. Put time under the microscope. You cannot manage time that is past. But you can examine how you managed it in an objective and realistic way.

(a) **Time Log.** For this, a key suggestion - keep a ‘Time Log’, a record of how you are spending your time. You could be in for a considerable shock. Yet that very shock could jolt you into action. It is an amazing revelation of how much time you are wasting. Time log - divide each day for the next week or two into one hour intervals. At the end of each day you record how the each hour was spent. Should occupy in all no more than five minutes a day. You may find that your 15 or 30 minute coffee break usually runs to thirty minutes. After keeping the logs for three or four days you may begin to notice opportunities for improvement. Could some tasks be delegated? What would happen if they were not done at all? Are you giving the really important tasks the correct priority? Look back at the end of each week. You may be surprised at what a comparatively small percentage of your time is actually going on the top-priority tasks on your list. Having identified how your time is truly spent you can then proceed to invest it more beneficially for the future.

(b) Developing a personal sense of time includes developing a personal sense of the value of other people’s time.

14. **Identify Long-Term Goals.**

(a) The foundation of good time management is to first, find out what matters deeply to you – what it is you really want to achieve in life. Spend time on considering what are your own personal values? What really matters to you at this stage of your life? Remember, they must be your values no-one else’s. In this, concentrate on four key areas of your life - Self & Well being, Community & Humanity, Home & Family & Business & Career. For instance, you may want to join a health club and participate very regularly, because you value keeping fit. You may also want to be upgraded in your teaching post because you value your job. When you analyze the time commitments for both activities, you may have to make a choice because you are so busy that there’s only time for one. Thus, in all these key areas, learn to focus on the vital few things which will make a long-term difference.

(b) This will tend to give you either a direction (or set of directions) in which you should be going, or a goal (or set of goals). As a principle, the further you look ahead the more likely you will be thinking in terms of directions or aims rather than goals or objectives.

(c) Thereafter, on a monthly basis, in each of the four key areas, considers what two or three main goals (or objectives) you would like to focus on, and record them. For eg., identify five or six key areas of your job. A key area is an area in which your performance will be directly or indirectly measured. In each of these key areas you need next to define or set objectives. That will give you a list of objectives for the middle term. It is often a good idea to make a ‘time budget’ for your objectives. You have only 168 hours each week. Common mistake is to underestimate the time it will take you to achieve a particular result. With practice and experience you should be able to forecast realistically and accurately how much of your time a job will take. At the end of the month, review your performance.

15. **Concentrate on High Return Activities.** In any organisation there are a few basic functions, which are central to its effective functioning. For a classroom teacher the high-return activity will be enabling the children to learn well. For a principal it will be empowering staff to be

effective teachers by having a smoothly running school. For a landscaper it will be building the right structures as economically as possible. Therefore, identify which activities are going to give you the highest return. And concentrate on them.

16. Weekly & Daily Planning.

(a) **The Mechanics of Weekly Planning.** Traditional time management teaching talks of daily planning, so why change? When, in a beautiful garden, we look closely at one plant, the rest of the garden will only be background. If, however, we stand back and take a wide – angle view of the whole garden, we get a clearer perspective of shape, colour, and layout. If we mainly focus on our daily scheduling, we're looking at what's under our nose & we tend to become immersed in the urgent. Hence, from our monthly goals / objectives, plan a weekly focus. Planning on a weekly basis helps us to take more control of our lives. We paint the picture of our life with broader brush-strokes. This helps us to achieve the things, which really matter, two or three major goals (or objectives) for each key area. We probably won't want to work on them all every week. So what happens to the ones not chosen this week? They are there to be observed. Have an awareness of it.

(b) **Example:** May be I want to start exercising more. This week my schedule is full and I don't have a chance of doing any extra exercise. By observing this reality, I am more likely to plan a sensible programme next week.

(c) Beware of one danger: don't try and bite off more than you can chew. Be realistic. Base your decision on what else is already planned for the week ahead. The trap that people often fall into is that they try and take on too much, and then give up in disappointment when they don't reach their objectives.

(d) At the beginning or end of each week set about fifteen minutes aside to plan the coming seven days. Review your monthly goals and reflectively consider which ones will need some attention this week. In each key area you wish to work in, aim for one or two small goals for the coming week. Review what you've done or not done in the preceding week. You may need to reschedule some things that remain to be done. Now, on your weekly planning sheet, in the time that you can control, block in appointments with yourself to do the proactive activities you've just decided on (and allow plenty of uncommitted time, because things always take longer than you think). The things you've blocked in are your high priorities. All the other things need to be listed somewhere so you don't forget them, but treat them as the less important things - put them on the back of your weekly planning sheet. Have fewer activities scheduled at the end of the week.

(e) **Daily Planning.** The longest journey begins with a single step. You will never achieve an objective if you do not break it down into manageable steps. Each day should see you some steps nearer to your desired result. Do not leave day planning to the last minute.

(i) Make out a list of what you want to do each day - mark them in order of priority. Do it the evening before, so that you can sleep on it. You may also review yesterday's plan – what remains to be done – transfer to today's plan. Check the weekly plan – transfer items for completion into today's plan.

(ii) A simple way of daily planning :-

(aa) Write down all the tasks you wish to do today.

(ab) Identify the five most important tasks, and number them in order of priority.

(ac) Start with no 1, don't leave it till you have finished, or gone as far as you can go today, and then start on the next item.

(ad) As extra items bounce at you throughout the day, deal with them if necessary. If not instantly urgent, add them to the list.

(ae) When the top five items have been completed, or taken as far as possible, repeat the prioritizing process, but include other things, which have jumped onto the list during the course of the day.

(af) Practice this system until you have learnt it.

(iii) Review each day briefly, identify the successes and analyze the reasons for failures. If you find that your daily planning is not working very well ask yourself first 'am I at least achieving my highest priorities?' If the answer is 'No' or 'Doubtful' you should work through the following checklist:-

(aa) Are you trying to accomplish too much in a day?

(ab) Did some tasks not get done because you were not ready at that time to do them?

(ac) Was the item or task clearly formulated? Did you have all the available information?

(ad) Did you abandon the task because it was too difficult or too boring?

(iv) A review of this kind can establish whether or not your time budget was realistic in the first place. If it was, then the problem lies in the execution.

17. **Make the Best Use of Your Best Time.** The quality of your attention or concentration varies at different times. You may notice that you habitually tend to be more mentally alert, at certain times of the day. 20% of your time produces 80% of your high-quality output. Consider your wardrobe. You probably wear 20 percent of your clothes 80 percent of the time. The most important tasks in a day only take about 20 percent of our time and will make 80 percent of the difference to the smooth running of things. So, make sure that you manage well that critical 20% of your time. Learn to focus on the vital few things which will make a long-term difference.

(a) Do you know clearly how much of a morning or night person you are? Do you regularly programme your day so that 'best time' is given to the highest-grade activities?

(b) Did you know that your manual dexterity – the speed and co-ordination with which you perform complicated tasks with your hands – peaks during the afternoon?

(c) Did you know that your short-term memory is best in the morning-in fact, about 15% more efficient than at any other time of the day? Also you tend to do best on cognitive tasks-things that require the juggling of words and figures in one's head – during the morning.

18. **Organise Office Work.** The place where much of the work is done. Concentrate on two key areas - controlling interruptions & organising paper work.

(a) **Controlling Interruptions.**

(i) Set a time limit and stick to it. Get them to the point.

(ii) With casual droppers – in, remain standing.

- (iii) Arrange to meet in the other person's office; you can then determine when to leave.
- (iv) Avoid small talk when you are busy.
- (v) Have a clock available where visitors can see it and don't be afraid to glance at it a few times.

(b) **Organising Paper Work.** Muddle makes work and wastes time. Strive for good order in your office. Establish systems for dealing with predictable and maintain them. Then you will find that you are free for the unpredictable – be they problems, crises or opportunities. It's OK if your desk looks like the recycling bin exploded. "If you can find most things in three minutes or less, your system is working".

- (i) Do you clear your desk of all papers except those relating to the particular job in hand?
- (ii) Is your workspace so organized that the things you need are to hand?
- (iii) Do you really try to handle each piece of paper only once?
- (iv) Do you sort paperwork into categories in priority order?
- (v) Have you eliminated unnecessary paperwork, and simplified the remainder where possible?
- (vi) Have you learnt to pick out quickly the key points or critical issue in letters and reports?
- (vii) Are you good at deciding what must be read through carefully and what can be skimmed?
- (viii) Have you developed a clear and succinct way of writing?

19. **Manage Meetings.** Meetings of all kinds – involve others. Therefore they are a potential time threat. Ask yourself three fundamental questions: Is this meeting really necessary? If so, how much of my time is the subject of it really worth? &, Will it begin on time and end on time? Remember a one hour meeting costs approx 0.06% of the annual salary of each person attending. The average person spends three to five years of their life in meetings and about 50 percent of the time is wasted! Hence, points to be borne in mind while organizing / attending meetings are :-

- (a) Always keep the objectives of meetings clearly in mind.
- (b) Plan ahead. Decide who is to be present and circulate the agenda in advance.
- (c) Fix time limits in advance, and start on time.
- (d) Budget specific amounts of time for each item on the agenda.
- (e) End on a positive note, with a summary of decisions taken and action to be implemented.

20. **Delegate Effectively.** Every position or role in an organisation has – defined responsibilities or functions, together with the authority to carry them out. Delegation saves your time and develops subordinates. It does not save the organization's time, for someone else's time is being used. But it improves results by making fuller use of resources.

(a) Decide what to delegate - repetitive routines of an administrative nature: minor decisions, technical or functional specialty activities, projects or tasks for which you are less qualified than some of your staff, work that will provide growth opportunities for employees & assignments that will give variety or add to job satisfaction.

(b) Demonstrate job, get feedback and comment from him & then get delegated to do job and observe. Resist temptations to get involved. If they come to you, try not to provide the answers but help them to find them. Aim is to develop the initiative of the subordinate. However, check progress at agreed points.

(c) To check if you are a good delegator, ask yourself these questions: Are there areas of your work that you should be delegating, but for some reason or other you are not ready to do so? Do you work for more than nine hours a day? Do you take homework at weekends? When you delegate, do you clearly define the tasks you are delegating and make sure that the person who is carrying them out knows exactly what is expected of them?

21. **Make Use of Committed Time.**

(a) You may sometimes complain that you lack time. But you have all the time there is for you. At work there is the time which you can choose to spend as you will – and, committed time. Committed time: If you are alert you may find portions of it, which are actually free time. Think of an example of committed time in the last week, where you found unexpectedly that you had at least half an hour to spare. What did you do with it? Could you have put that time to better use? What would you need to have had with you in order to do so?

(b) **Examples of Committed Time :Take Travel Time.** Could be put to profitable use; thinking, reading, and writing. Waiting time is another committed time which could be put into use. It is also healthier and more time efficient to travel by rail. Remember that a day has a hundred pockets of time if you know where to look for them.

22. **Manage Your Health.**

(a) Even a few weeks off being avoidably ill is going to involve you in a major waste of productive time. Depending on the nature of your illness, you may be able to use it in some constructive way. To give to your work and to others high quality time you must top up your energy levels. Are you overdrawn? Do you make a practice of playing back the bank – your body, mind and spirit?

(b) Do you get enough sleep? The norm is eight hours, slightly less as you grow older. You can function on much less, but your creativity is 15% down. Do you apply common sense to diet? The Golden rule is moderation in all things. Do you take exercise? Do you take holidays? Remember that you can do a full year's work in 11 months, but you cannot do it in 12 months. Do you allow time for reflection? It is a good idea to spend some time just meditating.

CONCLUSION

23. Time management should be fun. Keep it as simple as possible. The good news is that you will never meet the perfect time manager. You are probably very good - now you could be better. The wonderful thing is that tomorrow's 24 hours now await you – untouched and unwasted. You are now in a position to make more effective use of your time. Always remember, 'NOW' is the keyword of time management. If you want to reap in the future, you have to sow now. And, 'Your Time Starts Now'!

LESSON PLAN : P 11
EFFECTS OF LEADERSHIP WITH HISTORICAL EXAMPLES

Period	-	One
Type	-	Lec
Code	-	P 11
Term	-	II (SD/SW)

Training Aids

1. Computer Slides, Pointer, Charts, Black Board and Chalk.

Time Plan

2.

(a)	Introduction	-	05 Min
(b)	Historical Examples Prior to World War II	-	15 Min
(c)	Historical Examples After World War II	-	15 Min
(d)	Conclusion	-	05 Min

INTRODUCTION

3. When we study and analyse outstanding leaders in history, who have done some lasting good to mankind, a nation, a community, an organisation or a cause, we find that they are not similar. They come in all shapes and hues- the flamboyant; the scholarly; the artistic; the ascetic; the gregarious and the recluse. And yet, when we look deeper into their makeup, with common sense, we find something interesting. They have two things in common:-

(a) They are all persons of character, propelled by an ideal, or a vision. They also have character.

(b) They have an inner structure, which is composed of certain universal qualities.

4 The effect of leadership will be best understood by the various examples available in history.

AIM

5. To acquaint the cadets about Effects of Good Leadership with Historical Examples.

PREVIEW

6 The class will be conducted in the following parts:-

(a) Part I - Historical Examples Prior to World War II.

(b) Part II - Historical Examples After World War II.

PART I : HISTORICAL EXAMPLES PRIOR TO WORLD WAR II

Endurance (Alexander's Leadership)

7. Alexander, at the head of 30,000 foot-soldiers, with cavalry in the rear, was crossing the dreaded Gedrosian Desert in Asia Minor. It was mid summer and the yellow sands stretched to the horizon, with a few rocks jutting out here and there. It was hot like a furnace. They had completely run out of water. Arian, the most reliable historian of Alexander's conquests, records the incident in the following words:-

“Alexander, like everyone else, was tormented by thirst, yet he kept on marching on foot, leading his men. It was all he could do to - keep going, but he did so, and the result as always was that the men were better able to endure their misery, when they saw it was equally shared. As they toiled on, a party of light infantry, which had gone off looking for water found some, just a wretched little trickle collected in a shallow gully. They scooped up with difficulty what they could and hurried back, with their priceless treasure, to Alexander, then, just before they reached him, they tripped the water into a helmet and gave it to him. Alexander, with a word of thanks for the gift, took the helmet and, in full view of his troops, poured the water on the ground. So extraordinary was the effect of this action that the water wasted was as good as a drink for every man in the army. I cannot praise this act too highly; it was a proof, if anything was, not only of his power of endurance, but also of his genius for leader-ship”.

Character (World War-II)

8.. Before we have a look at the universal qualities common to all good leaders, we have to be quite clear in our mind about the frequently used word `Character`. Character is the most important factor which makes effective leaders. However, we have to describe a person of character with some clarity, so that there is a well articulated model, based on historical experience.

9. Descriptions of a person of character by a seasoned and highly respected war leader, General Mathew B Ridgeway of the US Army should provide the necessary clarity. A veteran of World War II, and a highly decorated officer, he rose to become the Supreme Commander of the UN Forces in Korea, and later was also the Chairman of the Joint Chiefs of Staff. He says:-

“Character stands for self discipline, loyalty, readiness to accept responsibility, and willingness to admit mistakes. It stands for selflessness, modesty, humility and willingness to sacrifice when necessary and, in my opinion, faith in God. Let me illustrate”. “During a critical phase of the ‘Battle of the Bulge’ in World War II, the Germans launched a counter offensive and nearly broke through the Allied lines in France. While I commanded the 18th Airborne Corps, another Corps Commander just entering the fight next to me remarked, ‘I am glad to have you on my flank. It is character that counts’. I had long known him and knew what he meant. I replied ‘That goes for me too’. There was no amplification, none was necessary. Each knew that the other would stick, how ever great the pressure; would extend help before it was asked, if he could; and would tell the truth; seek no self glory, and ever lastingly keep his word. Such men breed confidence and success.”

Decision Making (Operation Overlord)

10. The dilemma of the most momentous decision of military history is worth noting. During World War II, Operation Overlord, the Allied amphibious and airborne assault for the bridgehead in Europe was planned for 6 Jun 1944. It was the most complex operation ever attempted in history. The movement of troops, tanks and guns had already started and they were boarding their ships. Suddenly the weather report indicated a severe storm on 6 June. There was a huge cry for postponement of the D Day; to go on would be a disaster, particularly for the air borne operations.

Opinion of the experts was divided. Eisenhower, the supreme Commander, faced the biggest dilemma of his life.

11. Time was running out . He went away for a while to contemplate in silence. He decided to go on as planned, despite the warnings of a disaster, Before the invasion fleet set out, he wrote the following press release, to be issued if necessary:-

“Our landings have failed and I have withdrawn the troops.
My decision to attack at time and place,
was based on the best information available.
The troops, the Air and Navy did all that bravely
and devotion to duty could do.
If any blame or fault is attached to the attempt, it is mine.”

12. Needless to add - that the operation achieved complete surprise and was a success.

Will Power (Sir Winston Churchill)

13. ‘Try, try again’ is an age old advice based on the famous poem about Robert Bruce. The value of dogged perseverance was once articulated in a most dramatic manner by Sir Winston Churchill, who was the Prime Minister of the UK during World War II. He came out of the war as one of the tallest leaders in the world. He was invited by his school to be the guest of honour for the celebration of the 150th Anniversary of the school. He was also requested to deliver the keynote address to inspire the students to follow his example and become outstanding leaders in their lives. Churchill accepted the invitation. There was great expectation among all sections of society to listen to the views of Churchill on leadership.

14. On the appointed day, the hall where the function was being held, was overflowing with people .The media and the scholars had turned up in strength. Everyone was looking forward to Sir Winston revealing the secrets of his leadership.

15. After the usual courtesies, Churchill was invited to deliver his keynote address. He got up from his chair, walked slowly to the podium took out his small rectangular glasses and wore them. He then took out a small piece of paper, placed it in the podium and peered over his glasses at the audience. There was pin drop silence. He then delivered his address;

“NEVER – NEVER – NEVER – NEVER - GIVE UP”

16. Having roared these five words, he ambled back to his seat. There was a bewildered hush for a long time. However, his great message soon sank home. People stood up and gave him a long and thunderous ovation. In just five words. Churchill distilled the great secret of his leadership and success.

PART II : HISTORICAL EXAMPLES AFTER WORLD WAR II

Courage and Endurance (Saving Ladakh : 1947-48 War.)

17. Courage is the most admired human virtue in all societies; to be a man means to be courageous. The most important act of courage for a leader is to make decisions. No action can start unless a decision is made. To make a decision means being accountable for success or failure.

18. The strategy to save Ladakh was to hold on to Skardu at all cost, so that Pakistan led force may be prevented from reaching Kargil and Leh. Fortunately, we had the right man in Skardu to fulfill the mission. No words can describe the gallantry and leadership of Lieutenant Colonel Sher Jung Thapa, who held on to Skardu, with hardly 250 men, for six long months. It is one of the longest sieges in the annals of modern war. While ordering him to defend Skardu to the last Man

and last round, he was promised reinforcements and supplies. Unfortunately, neither could reach Skardu. Efforts were also made to air drop supplies and ammunition, but much of it fell outside his defences. Lieutenant Colonel Thapa then asked for discontinuing airdrop, as these were merely helping the enemy surrounding him. They held on even when they were on half and quarter day rations. At the end of six months when, he completely ran out of rations and ammunition, he was ordered to surrender. Thapa's response was "I know that I cannot hold out without rations and ammunition. I know the fate, I and my troops will meet after surrendering to the enemy. I cannot do anything now against the enemy, but I will certainly take revenge in my next life". It is officers of this stamp who make great armies and great nations.

Practice What You Preach (1971 War)

19. In another example, we shall see what happens when we do not practice what we preach. This example is from the 1971 War between India and Pakistan.

20. Brigadier Mohamed Latif of the Indian Army launched an attack to capture an enemy held hill top, nicknamed 'Baldy'. The hilly terrain surrounding the objective, was covered with dense pine forest. Brigadier Latif selected the Guards battalion for this tough task.

21. Hardly had the Commanding Officer of the Guards battalion finished reporting his success on the radio, a counter attack was launched by the enemy. The Guards were hardly organized to face a major counter attack. They had fought the whole day, suffered casualties, were short of ammunition and had eaten just one meal. Brigadier Latif warned The Guards to get ready and soon artillery shelling started from both sides. Brigadier Latif was mentally prepared to lose 'Baldy', because it would be a very unequal fight. When the counter attacking forces were about four hundred yards from 'Baldy', the Guards opened up with their machine guns. To the utter surprise and relief of Brigadier Latif, within minutes the entire counter attack petered away.

22. He could not believe his eyes, but congratulated the Guards for their performance. A little while later, the Guards reported that they had captured two unwounded prisoners.

23. The prisoners arrived at the command post almost at midnight. Towards the end of his interrogation, the Brigadier enquired from the Corporal "you seem to be a seasoned soldier. How come, you gave yourself up even when you were not wounded; not a very honourable action by a good soldier". The corporal was more than willing to explain and gave out his story, "Our commander was right in front when the counter attack started. Holding his sten in his one hand, he was encouraging us to wipe out your troops and recapture 'Badly'. He was inspiring us by loud talk. His booming voice could be heard all over. He was a towering personality. We were determined and enthusiastic to finish the task. We kept on advancing, even when your shelling started. When your troops opened fire with machine guns, our commander immediately took cover behind the trunk of a huge pine tree. Standing in that sheltered position, he waved his sten gun and ordered us to rush forward. But very soon we also started taking shelter behind the pine trees. I was unlucky to be captured by your patrol before I could slip away like others, down the slope and return to our base."

24. Here was a sure victory, on the plate, for the counter attacking force, but the commander was unable to set the right example. Good or bad personal example by a leader is most infectious. It is because of this that a Persian saying conveys a very stark truth:-

"If the king plucks one apple from the public Garden,
the public will take away even the roots".

Decision Making: Operation Meghdoot (Siachen Glacier)

25. Northern Command was ordered to prevent Pakistan troops from occupying the Siachen Glacier, to which they laid a claim. They were preparing to move in during the summer of 1984. After detailed discussions and war gaming, a plan was evolved. It had to be heli-borne

operation to neutralize the time and space advantage of Pakistani troops. The tentative D Day was fixed for May 84, a month before the area is normally approachable.

26. After a more deliberate thought, the Army Commander held a final discussion about the exact D Day. He felt that it should be as long before June as possible, to give the troops enough time to get properly organised before any reaction from the Pakistan side. The Brigade Commander responsible for mounting the operation suggested 13 April. The Army Commander approved the D Day and the plan was sent to Delhi.

27. Their reaction was that sending troops during the month of April, the month known for blizzards, would be plain murder. Here was typical dilemma. Should the advice of Army Headquarters be accepted or should Army Commander stick to his own judgment. D Day was not changed.

28. In the event, the first phase troops were ferried by helicopters to their objective on 13 April, without a hitch. However, by midday the weather packed up and second phase had to be called off. The blizzard that broke out raged for 72 hours. During this period the troops of first phase were completely out of communications. At 18,000 feet above the sea level, with the temperature at minus 60 degrees centigrade, their batteries froze. Morning and evening "we-told-you-so" calls to Northern Command from Army Headquarters were a nuisance and were totally ignored, because the troops had been properly prepared and equipped to face such an eventuality. No one in Northern Command had any fear about their survival.

29. On 17 April, the day was spotlessly clear, the first phase troops opened up their radio. The second phase troops were flown in and it was almost a week before the Pakistani troops, still training around Skardu, could reach. They launched a hurried attack, a week later, which was beaten back. The Indian troops are still holding on to the position they occupied in April 84, despite numerous attempts by Pakistani forces to dislodge them.

CONCLUSION

30. History is full of excellent leadership examples. Its only for us to read our past history and derive the best lessons from it. Napoleon once told his generals "Read, Read and Re – read past campaigns, because every time you read them, you will learn something new".

LESSON PLAN : P 12
STRESS MANAGEMENT SKILLS

Period	-	Two
Type	-	Lec
Code	-	P 12
Term	-	III (SD/SW)

Training Aids

1. Computer slides, Flip charts , Marker Pens, VIP cards of three different colours, A4 Size paper, Sketch pens – one for each participant, Bag containing cards with names of emotions such as happy, shy, sad, scared, excited, angry, envy, guilty, jealousy, love etc.

Time Plan

2.	(a)	Introduction	-	05 Min
	(b)	Understanding Stress and its impact	-	20 Min
	(c)	Stress Management Techniques	-	25 Min
	(d)	Understanding Emotions and Feelings	-	25 Min
	(e)	Conclusion	-	05 Min

INTRODUCTION

3. Stress is a very common phenomenon and is universal in nature. It is our body's reaction to people and events and to our own thoughts. Some level of stress is normal, such as before a test, stage performance or an athletic event. Coping with stress means recognizing the source of stress in our lives, recognizing how this affects us physically and emotionally, and acting in ways that help us control our levels of stress, by changing our environment or life style and learning how to relax.

AIM

4. To acquaint the cadets about Stress, its impact and how to Manage Stress.

PREVIEW

5. The class will be conducted in the following parts:-

- | | | | |
|-----|----------|---|--------------------------------------|
| (a) | Part I | - | Understanding Stress and its Impact. |
| (b) | Part II | - | Stress Management Techniques. |
| (c) | Part III | - | Understanding Emotions and Feelings. |

PART I : UNDERSTANDING STRESS AND ITS IMPACT

6. Stress is unique and personal to each of us. What is relaxing to one person may be stressful to another. But too much stress can have physical and psychological effects that interfere with the health and well-being of an individual. Overtime repeated stress can lower self-esteem, decrease academic performance and create a cycle of self-blame and self-doubt.

7. The key to reducing stress is to find strategies that help you as an individual. The best way to cope with unhealthy stress is to recognize when your stress levels are building. While we often think of stress as the result of external events, the events themselves are not necessarily stressful. It is the way we react to an event that causes stress.

8. The class will be introduced to understanding stress and its impact with an activity.

9. **Activity – Stress and its Impact on Us.** Distribute three cards, each with one of the following titles:-

(a) “Physical,” “Emotional and “Behavioral” to each participant.

(b) Ask the participants to imagine a stressful situation and write responses to the following questions:-

(i) What happens to their body when they are stressed? (Physical-e.g. headache, restless).

(ii) How do they feel when they are stressed?

(iii) What do they do when are stressed? (Behavioral -e.g. cry, shout at others).

10. Once they finish writing ask them to paste the card on the wall or board under each category separately.

11. **Expected Responses.**

(a) Effect on the body (Physical) – headache, grinding teeth, trembling.

(b) Effect on feelings (Emotional) – depressed, angry, irritated, anxious.

(c) Effect on behavior – do not sleep, eat a lot, do not eat, cry, break things, becomes silent.

12. The class will be explained that stress signals fall into four categories: thoughts, feelings, behaviours and physical symptoms. While under stress we may experience the following feelings, through, behaviours or physical symptoms:-

(a) **Feelings:** Anxiety, irritability, fear, moodiness, embarrassment.

(b) **Thoughts:** Self-criticism, difficult concentrating or making decisions, forgetfulness, pre-occupation with the future, repetitive thoughts, fear of failure.

(c) **Behaviour:** Stuttering, difficulty speaking, crying, acting impulsive, do not feel like talking to anyone, nervous laughter, yelling at friends and family, grinding teeth, jaw clenching, increased smoking, alcohol or drug use, increased or decreased appetite.

(d) **Physical Symptoms**: Tight muscles, cold or sweaty hand, headache, back or neck problems, sleep disturbance, abdominal pain, more colds and infections, fatigue, rapid breathing, pounding heart, trembling, dry mouth.

PART II : STRESS MANAGEMENT TECHNIQUES

13. There are many ways to manage negative stress. Everyone needs to find ways that work best for them.

(a) **Take Deep Breath**. Stress often causes us to breathe quickly and this almost always causes more stress. Try to take deep slow breaths. Breathe in through your nose and count as you breathe out through mouth. Inhale enough so your lower abdomen rises and falls.

(b) **Talk It Out**. When you feel stressed, try to express your feelings. Bottling of feelings can increase stress. Share your feelings. Perhaps a friend, family members, teacher can help you see your problem in a new way. Talking with someone else can help clear your mind of confusion so that you can focus on problem solving. Even if it is slightly embarrassing, asking for help after a problem occurs may avoid serious problems later. Writing down thoughts and feeling can help clarify the situation and give a new perspective.

(c) **Take A Break**. Recognize when you are most stressed and allow yourself some reasonable break. When things seem especially difficult, take a walk or otherwise change your scenery.

(d) **Create a Quite Place in Your Mind**. You cannot always run away, but you can dream. Imaging a quite place can you out of a stressful situation. When you have the chance, take a moment to close your eyes and imaging a place where you feel relaxed and comfortable. Notice all the details of your chosen place, including pleasant sounds, smells and temperature.

(e) **Pay Attention to Physical Comfort**. Be as physically comfortable as the situation will allow. Wear comfortable clothing. If it's too hot, go somewhere where it's not. If chair is uncomfortable, move. Do not wait until your discomfort turns into a real problem.

(f) **Move**. Physical activity can help reduce and prevent stress. When you feel nervous, angry or upset, release the pressure through exercise or physical activity. Try to find something you enjoy and make regular time for it. Running, stretching, walking or dancing can be done anywhere. Working in the garden, cleaning or playing with your younger children can relieve stress, make you relax and energize you.

(g) **Take Care of Your Body**. Healthy eating and adequate sleep fuels you mind as well as your body. Avoid eating too much caffeine and sugar. Well-nourished bodies are better able to cope with stress.

(h) **Laugh**. Maintain your sense of humour, including the ability to laugh at yourself. Share jokes and funny stories with your friends. Laughter is good for you.

(j) **Mange Your Time**. Plan ahead and make a realistic scheduled for yourself and include time for stress reduction as a regular part of your scheduled. Trying to take care of everything at once can seem overwhelming and may keep you from accomplishing anything. Instead, make a list of what you have to do, then do one at a time, checking them off as you finish. Do the most important ones first. If a particularly unpleasant task faces you, do it early in the day and get over with it; the rest of your day will be less stressful.

(k) **Know Your Limits**. When in a stressful situation, ask yourself" is this my problem? If it isn't, leave it alone. If it is, can resolve it now? Once the problem is settled, leave it

alone. Do not agonize over the decision, and try to accept situation you cannot change. There are many circumstances in life beyond your control. If problem is beyond your control and cannot be changed at the moment, learn to accept as it is, for now, until such time when you can change things.

(l) **Do You Have To Be Right Always?** Do you get upset when things don't go your way? Consider cooperation or compromise rather than confrontation. It may reduce the strain and help everyone feel more comfortable.

(m) **Have A Good Cry.** It is normal for people of all ages to cry. A good cry during stressful times can be a healthy way to bring relief to your stress, and may prevent a headache or other physical consequences of stress. However, crying daily can be sign of depression.

(n) **Look for the Good Things Around You.** It is easy to see only the negative side when you are stressed. Your thoughts can become like a pair of very dark glasses, allowing you to see very little light or joy in your life. Decide to notice five good things around you. These can be positive or enjoyable moments or interactions. These may seem like small events but as these good things add they can often provide a big lift to energy and spirits and help you begin to see things in a new, more balanced way.

(o) **Talk Less, Listen More.** Listening banishes stress, makes you more popular, more knowledgeable, more sensitive.

PART III : UNDERSTANDING EMOTIONS AND FEELINGS

14. The class will be introduced to various emotions by activity method.

15. **Activity One – Understanding Emotions.**

(a) **Step-1.** Prepare cards with names of some emotions such as happy, shy, scared, excited, angry, envy, guilty, jealousy, love etc. etc and put them in a bag. Note: Depending on the number of participants, you can have three-four cards having the same emotion.

(b) **Step-2.** Make the participants sit in a circle and pass the “parcel of emotions” while the music plays. When the music stops, the participant who has the parcel picks up a card from the bag and acts out the emotion described. No words are to be used. The rest of the participants have to guess the emotion expressed.

(c) **Step-3.** Also ask the participants to say instances where they will feel like the emotion mentioned (like one feels happy when everything goes their way).

(d) **Step-4.** Tell the participants that all emotions are integral part of life. Add information from the Facilitator's Guide 7.1.1.

16. **Activity Two- Mixing and Matching Feelings.**

(a) **Step-1.** Tell the participants that a good way to know our emotions is to understand our associated body language. Understanding how our body reacts to the feelings help us to think about the feeling and express it the way we choose.

(b) **Step-2.** Take one volunteer aside and tell him/her to say the following statement in four different ways sounding happy, fed-up, scared, and angry to the larger group. Ask the participants to identify the emotions he/she is expressing:-

(i) I was asked to go to the Principal's Office – (say it with excitement as if an honour is being given, and you are going to get some good news).

(ii) I was asked to go to the Principal's Office-(Say it as if you are fed-up of going there, you are bored).

(iii) I was asked to go the Principal's Office-(Say it as if you are scared, and you have no clue what is going to happen).

(iv) I was asked to go to the Principal's Office- (Say it as if you are angry at being asked to go-and as if an unfair event is taking place.

(c) **Alternative Statement.**

(i) My uncle from the neighbouring village will come to y home tomorrow.

(ii) I was asked to go to the village Pradhan's house.

(d) **Step - 3.** Explain that with every feeling there is an associated body language, which helps us understand the feeling-If we want to change the consequence, we need to understand the feeling and associated body language.

(e) **Step - 4.** Divide the participants into five groups - Give each group five feeling statements (given below) and place them on the floor/table for each group:-

(i) When I am angry.

(ii) When I am very sad.

(iii) When I am happy.

(iv) When I am very scared.

(v) When I am very nervous.

(f) **Step - 5.** Give each group a set of five body statements that have to be matched with the feeling statements. Give set a first, once they have completed Set A give Set B and following completion give Set C. Shuffle the statement cards before giving to the participants.

(i) **Set A Body Statements.**

(aa) I feel a lot of tension in my neck and my shoulders.

(ab) I feel empty inside.

(ac) I feel light, like I am flying in the air.

(ad) I feel weak at my knees.

(ae) I feel queasy or bad in my stomach.

(iii) **Set B Body Statements.**

(aa) I breathe shallow and quick.

(ab) My heart feels heavy.

(ac) I want to smile.

(ad) My heart beats very fast.

(ae) I can't sit still.

(iii) **Set C Body Statements.**

(aa) My head is about to burst and I perspire a lot.

(ab) I feel very tired and tears come from my eyes very fast.

(ac) I feel energetic.

(ad) Palms become very cold.

(ae) I have a headache.

17. An emotional experience is characterized by both external and internal changes in the human being. The external changes are those which are apparent and easily seen by others such as changes in facial expressions, changes in posture. By looking at the facial expressions we can find out if a person is angry, happy or depressed. Internal changes may include rapid pulse and breathing, increased blood pressure, sweating, dry mouth etc.

18. Individual variations in emotional expressions are primarily due to age and past experiences. Variations in expressions also occur within the individual, No one follows a consistent pattern at all time. How a person reacts to an emotion-provoking stimulus depends on his/her physical condition at that time, on the interests and activities that are preoccupying him/her at that time, on his/her mood, on the social group with which he/she happens to be etc.

CONCLUSION

19. Coping with stress means recognizing the source of stress in our lives, recognizing how this affects us physically and emotionally, and acting in ways that help us control our levels of stress, by changing our environment or life style and learning how to relax.

LESSON PLAN : P 13
INTERVIEW SKILLS

Period	-	Two
Type	-	Lec
Code	-	P 13
Term	-	III (SD/SW)

Training Aids

1. Computer Slides, Pointer, Charts, Black Board, Chalk, Pen, A-4 Paper.

Time Plan

2.

(a)	Introduction	-	05 Min
(b)	Curriculum Vitae	-	20 Min
(c)	The Interview	-	30 Min
(d)	Mock Interview	-	20 Min
(e)	Conclusion	-	05 Min

INTRODUCTION

3. This is a short guide to constructing an effective interview. Interviewing skills are similar to story-crafting skills. In both of them one completes the story in their mind through their own activity. In crafting a story, one decides what more to imagine; in interviewing, one asks questions to fill in what is needed to make a complete imagined picture.

AIM

4. To prepare the student for their roles as interviewers of experts upon successful completion. Students will be able to successfully preparing curriculum vitae and participate in a mock interview.

PREVIEW

5. The class will be conducted in the following parts:-

(a)	Part I	-	Curriculum Vitae.
(b)	Part II	-	Before the Interview.
(c)	Part III	-	Conducting Yourself during the Interview.
(d)	Part IV	-	Following through after the Interview.
(d)	Part V	-	Mock Interview.

PART I : CURRICULUM VITAE

6. **Curriculum Vitae.** An outline of a person's educational and professional history, it is usually prepared for job applications. Another name for a CV is a resume.

7. A CV is the most flexible and convenient way to make applications. It can convey your personal details in the way that presents you in the best possible light and can be used to make multiple applications to employers in a specific career area. There is no "one best way" to construct a CV. It is your document and can be structured and presented as you wish within the basic framework set out below.

8. **When Should a CV be Used?**

- (a) When an employer asks for applications to be received in this format.
- (b) When an employer simply states "apply to ..." without specifying the format.
- (c) When making **speculative applications** (when writing to an employer who has not advertised a vacancy but who you hope my have one).

9. **What Information Should a CV Include?**

- (a) Personal details.
- (b) Education & qualifications.
- (c) Work experience.
- (d) Interests and achievements.
- (e) Skills.
- (f) References (if required).

10. The order in which you present these, and the emphasis which you give to each one, will depend on what you are applying for and what you have to offer. The Personal details should be correct and accurate so that they don't have any difficulty in getting in touch with you. Your Professional profile should be relevant to the kind of job you are applying. And the best served and successful ones should head the list.

11. A **personal profile** at the start of the CV can sometimes be effective for jobs in competitive industries such as the media or advertising, to help you to stand out from the crowd. It needs to be original and well written. Don't just use the usual hackneyed expressions: "I am an excellent communicator who works well in a team.....".

12. You will also need a **Covering Letter** to accompany your CV, you should **personalize the covering letter** - e.g. by putting in a paragraph on why you want to work for that organization.

13. **What Makes a Good CV.** There is no single "correct" way to write and present a CV. The following general rules apply:-

- (a) It is targeted on the specific job or career area for which you are applying and brings out the relevant skills you have to offer.
- (b) It is carefully and clearly laid out: logically ordered, easy to read and not cramped.

- (c) It is informative but concise.
- (d) It is accurate - in content, spelling and grammar.

14. **How Long Should a CV Be.** There are no absolute rules on this but, in general, a new graduate's CV should cover **no more than two sides of A4 paper**. If you can summarize your career history comfortably on a **single side**, this is fine and has advantages when you are making speculative applications and need to put yourself across concisely. However, you should not leave out important items, or crowd your text too closely together, in order to fit it onto that single side. **Academic and technical CVs may be much longer** up to 4 or 5 sides.

15. **Tips on Presentation.**

(a) Your CV should be **carefully and clearly laid out** - not too cramped but not with large empty spaces either. Use bold and italic typefaces for headings and important information.

(b) Never back a CV - **each page should be on a separate sheet of paper**. It's a good idea to put your name in the footer area so that it appears on each sheet.

(c) **Be concise** - a CV is an appetizer and it should make the reader want to know more about you. Don't feel that you have to list every exam you have ever taken, or every activity you have ever been involved in - consider which are the most relevant and/or impressive.

(d) **Be positive** - put yourself over confidently and highlight your strong points. For example, when listing your A-levels, put your highest grade first.

(d) **Be honest** - although a CV does allow you to omit details (such as exam resits) which you would prefer the employer not to know about, you should never give inaccurate or misleading information.

(e) If you are posting your CV, **don't fold it** - put it in a full-size A4 envelope so that it doesn't arrive creased.

16. **Different Types of CV.**

(a) **Chronological.** Outlining your career history **in date order**, normally beginning with the most recent items (reverse chronological) . This is **the "conventional" approach and the easiest to prepare**. It is detailed, comprehensive and biographical and usually works well for "traditional" students with a good all-round mixture of education and work experience. Mature students, however, may not benefit from this approach, which does emphasize your age, any career breaks and work experience which has little surface relevance to the posts you are applying for now.

(b) **Skills-Based.** Highly-focused CVs which relate your skills and abilities to a specific job or career area by **highlighting these skills and your major achievements**. The factual, chronological details of your education and work history are subordinate. These works well for anybody whose degree subject and work experience is not directly relevant to their application. Skills -based CVs should be closely targeted to a specific job.

17. Ask the participants to fill in the blank format of CVs.

CURRICULUM VITAE

Your name (*capitalized, boldfaced and 16 pt. font*)
 Street Address
 Town
 Zip Code

Objective. (*List out your objective or aim like...*)

A challenging position with growth opportunities to nourish the objective of organization working with its values and skills.

Academic Qualifications. (*Each heading should be in capital letters and boldfaced*)

Examination	Board/university	Year of passing	%age
-------------	------------------	-----------------	------

Technical Qualification. (*List out any technical experience you have*)

Work Experience. (*List any job you have held*)

Job title	Company name	Location	Dates	Describe your position duties and skills learned using key verbs
-----------	--------------	----------	-------	--

Achievements. (*list any achievements, awards or special recognition you have received*)

Title of Achievements	Month	Year
-----------------------	-------	------

Curricular Activities (*volunteer work, etc.*)

Activity	Number of years
----------	-----------------

Interests. (*List a few of your hobbies if pertinent*)

Strengths. (*list a few of your strength*)

Personal Profile.

Name :
 Date Of Birth :
 Father's Name :
 Nationality :
 Languages Known :
 Contact No. :
 E-Mail Id :

(Your Signature block)

18. **Interview Skills.** The interview is the final hurdle most people have to cross in getting a job. Some colleges and scholarship committees also require interviews. Being chosen for an interview means someone is interested in your skills, knowledge and experience. However, a great application or resume can quickly find its way into the garbage if you do not come across well in an interview. You now must become a sales person. The interviewer is the buyer. They want to see if your talents meet their needs for the job or for admission to the college. Sell yourself

19. The interview is when you want to tell the employer or admissions representative about your strengths, skills, education, and work experience. Knowing yourself - positively selling your strong points - is what is going to get you the job or admission to the college. The easiest way to learn something is to break it down into parts. The interview process has five distinct parts.

PART II : BEFORE THE INTERVIEW

20. **Before the Interview.**

- (a) Do your homework! Learn as much as you can about the company or college before the interview.
- (b) Do some research: ask people who work there, go to the library, look on the internet, and make an anonymous call to the secretary. Find out what services/products the company provides, how long they have been in business, whether the company is growing or downsizing, the company's.
- (c) Reputation, etc. An interviewer will be impressed that you have made an effort to learn about the company or college. Read any material they send you!
- (d) Know where you are going. Drive by the site of the interview a day or two before the interview.
- (e) Arrive 5 - 15 minutes early.
- (f) Be prepared when you go to the interview. Bring extra copies of your resume, your portfolio, a notepad with some questions prepared for the interview, and a pen.
- (g) Dress for Success! Hair should be clean and combed. Fingernails must be clean with no gaudy polish. Keep perfume, cologne and aftershave to a minimum. Brush your teeth and don't forget deodorant.
 - (i) **Women.** Dress, skirt (not too short), or dress pants with a nice blouse or blazer. No excessive jewelry, make-up, or "big hair."
 - (ii) **Men:** Pants (not jeans!), collared shirt, tie, sport coat and shoes. A suit is not always necessary.

PART III : CONDUCTING YOURSELF DURING THE INTERVIEW

21. The major points that are important will include the following:

- (a) Try to remember persons' names, and call each person by his or her name.
- (b) Always focus on the person asking the question, but use your peripheral vision to observe the facial and other nonverbal expressions of others involved in the interview.
- (c) If you don't have an answer to a specific question, respond honestly that you don't know much about that topic.
- (d) Be aware of your tone of voice and your body language. Do not, for example, slouch and put your arms on a table. Also, do not display nervous mannerisms or speak with a strained voice.
- (e) Don't try to answer a question immediately; if you want to, take a little time to provide a more complete answer.
- (f) Always answer each question honestly, because you will probably have to live with what you present. Being dishonest in your answers may occasionally assist you in obtaining the position you desire, but you will have to live with the dishonesty. If you have presented a false image and you behave differently on the job, you may soon be on your way out.

(g) Display a good knowledge of the district, based upon all the homework you have done. However, do not bury the interviewers with your knowledge, as you may very well turn them off. Also, if you display greater knowledge of a variety of subjects than the interviewers, you may scare them off from your candidacy.

(h) Don't argue if you disagree with the opinion of an interviewer. If you can, avoid them.

(j) At the end of the interview, you will often be asked whether you have any questions for the interviewer(s). It is wise, at this point, to respond:-

(i) That the interviewers and your homework have provided you with all the information that you feel you need, but ask permission to call to obtain additional information if you think of something important that you missed.

(ii) Ask if you can take a few minutes to stress why you desire the specific job in the specific district, emphasizing strengths that you will bring to the position.

(k) If you have materials that you would like the interviewers to review, do not hand them out prior / during the interview.. If you do this, the interviewers many times will be reading your handout materials rather than paying attention to what is being discussed during the interview.

(l) At the end, make certain to express your gratitude for being given the opportunity for the interview.

(m) At the very end, provide an additional copy of your resume to each person conducting the interview. This will probably be taken home and will remind them of you when they think about a final employment decision. This is especially important if you were fortunate enough to obtain the final interview.

(n) Throughout the entire interview, respond with sincerity, tact, and a high degree of interest.

(o) Engage in active listening. Pay attention to the emotional tone of the interviewer, not just the words he or she utters.

(p) Most important, throughout the entire interview situation, display life, pep, enthusiasm. Let your personality shine and display a high interest for the job for which you are interviewed.

22. A final recommendation is that you attempt to obtain the final interview if multiple candidates are being interviewed. This has the following advantages:-

(a) You will be the last person the interviewers will see and the last contact in their memories;

(b) If the interviewers are not experienced, they will become accustomed to the process and be much more at ease when your turn comes to be interviewed.

(c) If you can have a friend or someone you know observe the prior interviews and provide you with feedback, you will have attained much valuable information that will assist you when you are interviewed.

PART IV : FOLLOWING THROUGH AFTER THE INTERVIEW

23. Once your interview has been completed and you have returned home, don't forget to follow through with the interviewers. Write a letter of thanks, and inform the interviewers that you would very much like to serve in the administrative position they have announced. Also, if you have picked up on areas of specific interest to a certain member of the interview team, try to find interesting information about that subject and send it to that person. Also, include a note that indicates your high degree of mutual interest in that specific area.

24. The advantages of this approach are that:

- (a) It shows courtesy and the fact that you appreciated the interview.
- (b) It allows you a final chance to impress the individual interviewers.
- (c) It gives them a final contact that makes you memorable with the interviewers.

25. Why People Aren't Hired:

- (a) Poor personal appearance.
- (b) Inability to communicate clearly, poor voice, and grammar.
- (c) Lack of planning for a career...no purpose or goals.
- (d) Lack of enthusiasm and confidence in the interview.
- (e) Condemning past employers.
- (f) Failure to look the interviewer in the eye.
- (g) Limp handshake.
- (h) Late to the interview.
- (j) Does not thank the interviewer for his/her time.
- (k) Asks no questions.
- (l) Lack of knowledge about the business or the position.

26. **Interview Questions To Think About.**

Questions Often Asked By Employers		Questions Often Asked By Applicants	
1.	Tell me about yourself.	1.	What are the strengths of the organization or department?
2.	What are your short-range and long-range career goals, and how are you preparing to achieve them?	2.	What are the career opportunities for someone entering this position?
3.	Why did you choose this career?	3.	What kind of orientation and training is available to new employees?

4.	What do you consider to be your greatest strengths? Weaknesses?	4.	How large is the company/college? How large is this particular department/major?
5.	How would you describe yourself? How would a friend or professor describe you?	5.	To whom would I be reporting and what kind of communication channels are there?
6.	How has your college experience prepared you for your career?	6.	What are the long-range plans for this organization?
7.	Why should I hire you?	7.	How long was my predecessor in this position? Why did he/she leave?
8.	How do you determine or evaluate success?	8.	How will I be evaluated? How often?
9.	In what ways do you think you can make a contribution to our company?	9.	Is there an opportunity to transfer from one division to another?
10.	Describe the relationship that should exist between a supervisor and those reporting to him/her.	10.	What are the prospects for promotion in the future? What are some of the qualities or accomplishments you would consider important for promotion?
11.	Describe your most rewarding high school/college experience.	11.	What is the management philosophy of this organization? What is the general philosophy?
12.	If you were hiring for this position, what qualities would you look for?	12.	In what areas of the organization do you expect growth?
13.	What led you to choose your field or major?	13.	Is continuing education encouraged? Is tuition reimbursement offered?
14.	What have you learned from participation in extracurricular activities?	14.	Can you tell me about the history of this position, and changes anticipated?
15.	How do you work under pressure?	15.	What are your expectations of the person in this position?
16.	Describe the ideal job/college.	16.	Is overtime the norm in this office?
17.	Why did you decide to seek a position with this organization and what do you know about us?	17.	What kind of support staff is available? What is the ratio of support staff to professionals, and how is work distributed?
18.	What major problems have you encountered and how did you deal with it?	18.	Generally, what percentage of time will be devoted to each of my responsibilities?
19.	What criteria are you using to evaluate the company/college for which you hope to work/attend?	19.	Do you work with daily, weekly, monthly, or annual deadlines?
20.	What salary do you want?	20.	Does the organization have a process for sharing creative ideas?

PART V : MOCK INTERVIEW

26. **Mock Interview Evaluation:** Wrap up the discussion by showing students the How Are You Rated during the Interview? Students will participate in brief (5 - 10 minute) mock interviews to develop skills in the interviewing process. The Mock Interview Evaluation form has been included to provide students with feedback.

MOCK INTERVIEW EVALUATION

INTERVIEWER :	
STUDENT :	
DATE OF INTERVIEW :	

27. Rate the student interviewee on a scale of 1 (lowest) to 5 (highest) in the following areas of interviewing skill.

<u>NON-VERBAL BEHAVIORS</u>						
1.	Dressed appropriately	1	2	3	4	5
2.	Firmly shook hands of interviewer before and after	1	2	3	4	5
3.	Maintained eye contact with interviewer	1	2	3	4	5
4.	Maintained good posture	1	2	3	4	5
5.	Did not fidget	1	2	3	4	5
6.	Used hands for emphasis where appropriate	1	2	3	4	5
<u>VERBAL BEHAVIORS</u>						
1.	Listened closely to questions	1	2	3	4	5
2.	Answered questions completely, yet briefly	1	2	3	4	5
3.	Greeted interviewer by name	1	2	3	4	5
4.	Thanked interviewer	1	2	3	4	5
5.	Emphasized qualifications	1	2	3	4	5
6.	Pointed out work-related skills	1	2	3	4	5
7.	Displayed enthusiasm	1	2	3	4	5
8.	Focused on strengths; avoided weaknesses	1	2	3	4	5
9.	Acted in polite manner	1	2	3	4	5
10.	Stayed calm	1	2	3	4	5
11.	Responded to questions promptly, but not hurriedly	1	2	3	4	5
12.	Knows when a decision will be made	1	2	3	4	5
13.	Asked appropriate questions of the interviewer	1	2	3	4	5
14.	Spoke clearly and at a reasonable volume	1	2	3	4	5
15.	Demonstrated knowledge of the field/company	1	2	3	4	5
16.	Avoided use of phrases such as "um" & "you know"	1	2	3	4	5
17.	Stated career goal(s) and related it to position	1	2	3	4	5

CONCLUSION

28. Interviewing is one of the most important skills one can have in the workplace. You cannot move in or up without passing the interview. Yet as important as it is, few people ever take the time to study material on the skills needed to master that process. They go in to an interview, answer the questions as best as they can and hope for the best. However, there is a technique to interviewing. It's just as important as your CVs', skills, experience, and accomplishments.

LESSON PLAN : P 14
CONFLICT MOTIVES - RESOLUTION

Period	-	Two
Type	-	Lec
Code	-	P 14
Term	-	II (SD/SW)

Training Aids

1. Computer Slides, Pointer, Charts, Black Board, Chalk.

Time Plan

2.	(a)	Introduction	-	05 Min
	(b)	Motives of Conflict	-	15 Min
	(c)	Levels of Conflict	-	20 MIN
	(d)	Methods of Conflict Resolution	-	15 Min
	(e)	Conclusion	-	05 Min

INTRODUCTION

3. Conflict occurs between people in all kinds of human relationships and in all social settings. Because of the wide range of potential differences among people, the absence of conflict usually signals the absence of meaningful interaction. Conflict by itself is neither good nor bad. However, the manner in which conflict is handled determines whether it is constructive or destructive. Conflict is defined as an incompatibility of goals or values between two or more parties in a relationship, combined with attempts to control each other and antagonistic feelings toward each other. The incompatibility or difference may exist in reality or may only be perceived by the parties involved. Nonetheless, the opposing actions and the hostile emotions are very real hallmarks of human conflict. Conflict has the potential for either a great deal of destruction or much creativity and positive social change. Therefore, it is essential to understand the basic processes of conflict so that we can work to maximize productive outcomes and minimize destructive ones.

AIM

4. To acquaint the cadets about Conflicts and their Resolution.

PREVIEW

5. The class will be conducted in the following parts:-
 - (a) Part I - Motives of Conflict.
 - (b) Part II - Levels of Conflict.
 - (c) Part III - Methods of Conflict Resolution.

PART I : MOTIVES OF CONFLICT

6. **Conflict.** Conflict is a condition that exists when two sets of demands, goals, or motives are incompatible or unmatchable. Negotiation is treated as an important way of resolving conflict.

7. **Motives for Conflict.**

(a) **Competition for Limited Resources.** People squabble because not everybody can get all the resources he or she wants.

(b) **The Generation Gap and Personality Clashes.** Differences in age, or the generation gap, can lead to conflict because members of one generation may not accept the values of another. Disagreements on the job also stem from personality clashes, or antagonistic relationships between two people based on differences in personal attributes, preferences, interests, values, and styles. Clashes sometimes surface after people have been working together harmoniously.

(c) **Aggressive Personalities.** Some workers convert disagreement into an attack. Aggressive personalities are people who verbally, and sometimes physically, attack others frequently. Verbal aggression takes the form of insults, teasing, ridicule, and profanity. Aggressiveness can also lead to violence.

(d) **Culturally Diverse Teams.** Conflict often surfaces as people work in teams whose members vary in many ways. Ethnicity, religion, and gender differences are three of the main factors that lead to clashes in viewpoints. Differing educational background and work specialties can also lead to conflict. Yet, with direction, most groups can overcome these conflicts.

(e) **Competing Work and Family Demands.** Balancing the demands of work and family life is a major challenge facing workers at all levels. The challenge of achieving balance is particularly intense for employees who are part of a two-wage earner family. Work-family conflict occurs when the individual has to perform multiple roles: worker, spouse or partner and often parent. Work-family conflict is related to depression and other stress-related health problems. Work/family programs are aimed directly at reducing conflict stemming from competing work and family demands. These programs include flexible work schedules, dependent-care programs and compassionate attitudes toward individual needs.

(e) **Gender Based Harassment.** Gender-based harassment is generally defined as unwanted behaviors between males and females at workplaces. Such behaviors result in discomfort and/or interference with the job. Gender-based harassment creates conflict because the harassed person has to make a choice between the job or harassment. Surveys and opinions suggest that somewhere between 50 percent and 60 percent of women are harassed by male at least once in their career in the West. Aside from being an illegal and immoral act, gender-based harassment has negative effects on the well-being of its victims. The harassed person may experience job stress, lowered morale, severe conflict, and lowered productivity.

8. **Merits and Demerits of Conflict.**

(a) Conflict has both positive and negative consequences, much like work stress. On the positive side, the right amount of conflict enhances mental and emotional functioning and may lead to improved relationships.

(b) Conflict also helps prevent groupthink (over agreement to achieve cohesion). On the negative side, intense conflict may lead to physical and mental illness, wasted

resources, sabotage, excessive fatigue, and workplace violence including homicide. Disgruntled employees may seek

PART II : LEVELS OF CONFLICT

9. Conflict can occur at a number of levels of human functioning. Conflict in your head between opposing motives or ideas is shown by your “internal dialogue” and is at the intrapersonal level. Beyond that, the primary concern here is with social conflict, i.e., conflict between people whether they are acting as individuals, as members of groups, or as representatives of organizations or nations.

10. **Interpersonal Conflict.** Occurs when two people have incompatible needs, goals, or approaches in their relationship. Communication breakdown is often an important source of interpersonal conflict and learning communication skills is valuable in preventing and resolving such difficulties. At the same time, very real differences occur between people that cannot be resolved by any amount of improved communication. “Personality conflict” refers to very strong differences in motives, values or styles in dealing with people that are not resolvable. For example, if both parties in a relationship have a high need for power and both want to be dominant in the relationship, there is no way for both to be satisfied, and a power struggle ensues. Common tactics used in interpersonal power struggles include the exaggerated use of rewards and punishments, deception and evasion, threats and emotional blackmail, and flattery or ingratiation. Unresolved power conflict usually recycles and escalates to the point of relationship breakdown and termination.

11. **Role Conflict.** Involves very real differences in role definitions, expectations or responsibilities between individuals who are interdependent in a social system. If there are ambiguities in role definitions in an organization or unclear boundaries of responsibilities, then the stage is set for interpersonal friction between the persons involved. Unfortunately, the conflict is often misdiagnosed as interpersonal conflict rather than role conflict, and resolution is then complicated and misdirected. The emotional intensity is often quite high in role conflict since people are directly involved as individuals and there is a strong tendency to personalize the conflict.

12. **Intergroup Conflict.** Occurs between collections of people such as ethnic or racial groups, departments or levels of decision making in the same organization, and union and management. Competition for scarce resources is a common source of intergroup conflict, and societies have developed numerous regulatory mechanisms, such as collective bargaining and mediation, for dealing with intergroup conflict in less disruptive ways. Social-psychological processes are very important in intergroup conflict. Group members tend to develop stereotypes (oversimplified negative beliefs) of the opposing group, tend to blame them for their own problems (scapegoating), and practice discrimination against them. These classic symptoms of intergroup conflict can be just as evident in organizations as in race relations in community settings. Intergroup conflict is especially tense and prone to escalation and intractability when group identities are threatened. The costs of destructive intergroup conflict can be extremely high for a society in both economic and social terms.

13. **Multi-Party Conflict.** Occurs in societies when different interest groups and organizations have varying priorities over resource management and policy development. These complex conflicts typically involve a combination of economic, value and power sources. This complexity is often beyond the reach of traditional authoritative or adversarial procedures, and more collaborative approaches to building consensus are required for resolution.

14. **International Conflict.** Occurs between states at the global level. Competition for resources certainly plays a part, but value and power conflict are often intertwined and sometimes predominate. The differences are articulated through the channels of diplomacy in a constant game of give and take, or threat and counterthreat, sometimes for the highest of stakes. Mechanisms of propaganda can lead to many of the same social-psychological distortions that characterize interpersonal and intergroup conflict

PART III : METHODS OF CONFLICT RESOLUTION

15. Regardless of the level of conflict, there are differing approaches to deal with the incompatibilities that exist. Conflict can result in destructive outcomes or creative ones depending on the approach that is taken. If we can manage conflict creatively, we can often find new solutions that are mutually satisfactory to both parties. Sometimes this will involve a distribution of resources or power that is more equitable than before, or in creating a larger pool of resources or forms of influence than before. Creative outcomes are more probable when the parties are interdependent, i.e., each having some degree of independence and autonomy from which to influence the other, rather than one party being primarily dependent on the other. Given interdependence, three general strategies have been identified that the parties may take toward dealing with their conflict; win-lose, lose-lose, and win-win.

17. **The Win-Lose Approach.** Is all too common. People learn the behaviors of destructive conflict early in life – competition, dominance, aggression and defense permeate many of our social relationships from the family to the school playground. The “fixed pie” assumption is made, often incorrectly, that what one party gains, the other loses. The strategy is thus to force the other side to capitulate. Sometimes, this is done through socially acceptable mechanisms such as majority vote, the authority of the leader, or the determination of a judge. Sometimes, it involves secret strategies, threat, innuendo – whatever works is acceptable, i.e., the ends justify the means. There is often a strong we-they distinction accompanied by the classic symptoms of intergroup conflict. The valued outcome is to have a victor who is superior, and a vanquished who withdraws in shame, but who prepares very carefully for the next round. In the long run, everyone loses.

18. **The Lose-Lose Strategy.** Is exemplified by smoothing over conflict or by reaching the simplest of compromises. In neither case is the creative potential of productive conflict resolution realized or explored. Disagreement is seen as inevitable, so therefore why not split the difference or smooth over difficulties in as painless a way as possible? Sometimes, this is indeed the reality of the situation, and the costs are less than in the win-lose approach, at least for the loser. Each party gets some of what it wants, and resigns itself to partial satisfaction. Neither side is aware that by confronting the conflict fully and cooperatively they might have created a more satisfying solution. Or the parties may realistically use this approach to divide limited resources or to forestall a win-lose escalation and outcome.

19. **The Win-Win Approach.** Is a conscious and systematic attempt to maximize the goals of both parties through collaborative problem solving. The conflict is seen as a problem to be solved rather than a war to be won. The important distinction is we (both parties) versus the problem, rather than we (one party) versus they (the other party). This method focuses on the needs and constraints of both parties rather than emphasizing strategies designed to conquer. Full problem definition and analysis and development of alternatives precedes consensus decisions on mutually agreeable solutions. The parties work toward common and superordinate goals, i.e., ones that can only be attained by both parties pulling together. There is an emphasis on the quality of the long term relationships between the parties, rather than short term accommodations. Communication is open and direct rather than secretive and calculating. Threat and coercion are proscribed. The assumption is made that integrative agreements are possible given the full range of resources existing in the relationship. Attitudes and behaviors are directed toward an increase of trust and acceptance rather than an escalation of suspicion and hostility. The win-win approach requires a very high degree of patience and skill in human relations and problem solving.

20. **Techniques for Resolving Conflicts.** Here are some field-tested approaches to conflict resolution. Most of them emphasize a collaborative or win-win philosophy.

(a) **Confrontation and Problem Solving Leading to Win-Win.**

(i) The most highly recommended way of resolving conflict is confrontation and problem-solving. The person identifies the true source of conflict and then resolves it systematically using a problem-solving approach.

- (ii) Tactfulness is recommended.
 - (iii) The approach to confrontation and problem solving is for each side to list what the other side should do. The two parties then exchange lists, and select a compromise both sides are willing to accept.
 - (iv) The intent of confrontation and problem solving is to arrive at a collaborative solution to conflict.
 - (v) The collaborative style is based on an underlying philosophy of win-win, the belief that after conflict has been resolved, both sides should gain something of value.
- (b) **Disarm the Opposition.** Disarm the opposition is a method of conflict resolution in which you disarm the criticizer by agreeing with his or her criticism of you. The act of agreeing is disarming if you agree with the criticism, the criticizer no longer has reason to use his or her armament Disarming generally works more effectively than counter attacking a person with whom you are in conflict.
- (c) **Cognitive Restructuring.** According to the technique of cognitive restructuring, you mentally convert negative aspects into positive ones by looking for positive elements in a situation. If your search for the beneficial elements in a situation, there will be less area for dispute.
- (d) **Appeal to Third Party.** If you cannot resolve the problem yourself, make a formal appeal to a higher-level official or authority. Virtually all employers have some sort of appeal process. A labor union represents another method of appealing to a third party.
- (e) **The Grievance Procedure.** The formal process of filing a complaint and resolving a dispute is the grievance procedure. It can also be regarded as a third-party method of resolving conflict. The steps in the grievance procedure may vary from one to six. Typical steps are as follows:
- (i) Initiation of the formal grievance.
 - (ii) Second-level of management.
 - (iii) A higher-level manager and the local union president
 - (iv) Arbitration. (Only about 1 percent of grievances go all the way to arbitration.)

CONCLUSION

21. Knowledge about conflict motives and their resolution is extremely important and helpful in dealing with personal. It helps in self-growth as also growth of the organization. We must therefore continuously focus on methods of conflict resolution.

LESSON PLAN : P 15
IMPORTANCE OF GROUP / TEAM WORK

Period	-	Two
Type	-	Lec
Code	-	P 15
Term	-	III (SD/SW)

Training Aids

1. Computer Slides, Pointer, Charts, Black Board, Chalk.

Time Plan

- | | | | | |
|----|-----|-------------------------------------|---|--------|
| 2. | (a) | Introduction | - | 05 Min |
| | (b) | Types and Characteristics of Groups | - | 35 Min |
| | (c) | Types and Characteristics of Teams | - | 35 Min |
| | (c) | Conclusion | - | 05 Min |

INTRODUCTION

3. It is a universal truth that teamwork is the ability to work together toward a common vision. It divides the task and multiplies the success. Teamwork is the fuel that allows common people to attain uncommon results. The opportunity to work with others, rather than on your own, can provide distinct benefits. Groups that work well together can achieve much more than individuals working on their own. A broader range of skills can be applied to practical activities and sharing and discussing ideas can play a pivotal role in deepening your understanding of a particular subject area. Being a part of a team will help you develop your interpersonal skills such as speaking and listening as well as team working skills such as leadership, and working with and motivating others.

AIM

4. To acquaint the cadets of the Importance of Group / Team Work.

PREVIEW

5. The class will be conducted in the following parts:-
 - (a) Part I - Types and Characteristics of Groups.
 - (b) Part III - Types and Characteristics of Teams.

PART I : TYPES AND CHARACTERISTICS OF GROUPS

6. **Definition of a Group.** A group can be defined as any number of people who share goals, often communicate with one another over a period of time, and are few enough so that each individual may communicate with all the others, person-to-person. Two or more people interacting to achieve a common objective is also called a group.

7. **Classification / Types of Groups.** Groups can be following types:-

(a) **Friendship Group.** It evolves informally to meet its members' personal security, esteem and belonging needs.

(b) **Task Group.** It is created by the management to accomplish certain organization goals. Task group can further be classified as under:-

(i) **Formal Groups.** They are established by an organization to facilitate the achievement of the organization goals.

(ii) **Informal Group.** It is one that develops out of the day-to-day activities, interactions and sentiments of the members for the purpose of meeting their social needs.

(iii) **Effective Group.** An effective group is one which has the following characteristics:-

(aa) Its members know why the group exists; they have shared goals.

(ab) Its members support agreed upon guidelines and procedures for making decisions.

(ac) Its members communicate freely among themselves.

(ad) Its members have learned to receive help from one another and to give help to one another.

(ae) Its members have learned to deal with conflict within the group.

(af) Its members have learned to diagnose individual and group processes and improve their own and the group's functioning.

8. **Importance of a Group.**

(a) In a group people come together to achieve some common objectives for which they work in a structured fashion and utilise resources to reach pre-determined goals and targets.

(b) A group carries a lots of power in it. One work which seems impossible, can be done by a group strength very easily. We have a number of examples of group work around us. India is itself a great example of group work. India is probably the only country in the world where people belong to different languages, having different cultures, modes of living, clothing, feeding habits and even different Gods and deities. In spite of all these differences, they live together in harmony and even believe to be the children of one mother called "Mother India".

(c) We are one large nation with one central authority. In India we have unity in diversity and we work together to make our country a developed country. It is because of the strength of the nation as a group only that India could achieve freedom in 1947.

9. **Characteristics of a Mature Group.**

(a) An increasing ability to be self-directed (not dependent on the leader).

(b) An increased tolerance that progress takes time.

- (c) An increasing sensitivity to their own feelings and those of others.
- (d) Improvement in the ability to withstand tension, frustration and disagreement.
- (e) A perception of the common denominators, which bind the group as well as areas of individual difference.
- (f) A better ability to anticipate realistic results of behavior to channel emotions into more socially acceptable ways of expressing these emotions.
- (g) An increased ability to change plans and methods as new situations develop.
- (h) A decrease in time needed to recover from threatening group situations. Peaks and valleys of emotional group crises become less personal.
- (j) Increased efficiency in locating problems, engaging in problem solving and providing help to individuals as needed.
- (k) A willingness to face one's own responsibilities and to assist others when help is needed.
- (l) An acceptance of the right of the other person to be different.

PART II : TYPES AND CHARACTERISTICS OF A TEAM

10. **Definition of a Team.** When two or more people who are interdependent, who share responsibility for outcomes, who see themselves and are seen by others as an intact social entity in a larger social system are called as "Teams". When teams are formed, its member must have (or quickly develop) the right mix of complementary competencies to achieve the team's goals. Also its members need to be able to influence how they will work together to accomplish those goals.

11. **Types of Teams.**

- (a) **Functional Teams.** They usually represent individuals who work together daily on a cluster of ongoing and independent tasks. Functional teams often exist within functional departments, marketing, production, finance, auditing, human resources and the like.
- (b) **Problem Solving Teams.** They focus on specific issues in their areas of responsibility, develop potential solutions and are often empowered to take actions within defined limits.
- (c) **Cross - Functional Teams.** They bring together the knowledge and skills of people from various work areas to identify and solve mutual problems.
- (d) **Self - Managed Teams.** They normally consist of employees who must work together effectively daily to manufacture entire product (or major identifiable component) or service.

12. **Importance of a Team.**

- (a) A team is a small number of employees with complementary competencies (abilities, skills and knowledge) who are committed to common performance, goals and working relationship for which they hold themselves mutually accountable.
- (b) A key aim of teamwork is group synergy, namely the achievement of high quality as a result of combined individual contributions . Synergy can help you solve complex

problems because you will be working with people who have a wide range of skills and perspective. Students working in teams benefit particularly from brainstorming and bouncing ideas of each other, learning from each other, discussing work in teams outside contact times and checking results.

(c) In a team we can establish an agreed set of team guidelines. We know team members, their strengths, and preferred ways of working and preferred roles. We can discuss the task problems to arrive at a shared understanding and summarise this shared understanding of any project.

13. **Characteristics of a Team.**

- (a) Illusion of invulnerability.
- (b) Collective rationalization.
- (c) Unquestioned belief.
- (d) Stereotypical views.
- (e) Direct pressure.
- (f) Self censorship.
- (g) Shared illusion of unanimity.

CONCLUSION

14. Working in groups and teams requires a lot of tolerance and time to come to conclusions and make decisions. Cooperation and respect for group / team norms are important in group / team work. Some group / team members may be able to do tasks alone, but success for one group / team member does not mean success for the entire group / team. Group / team members should accomplish a shared task or goal together.

LESSON PLAN : P 16
INFLUENCING SKILLS

Period	-	Two
Type	-	Lec
Code	-	P 16
Term	-	III (SD/SW)

Training Aids

1. Computer Slides, Pointer, Charts, Black Board, Chalk.

Time Plan

2.

(a)	Introduction	-	05 Min
(b)	Influencing Skills	-	10 Min
(c)	Types of Influencing Skills	-	30 Min
(d)	Laws and Principles of Influencing	-	30 Min
(c)	Conclusion	-	05 Min

INTRODUCTION

3. Influencing others and negotiating for what you need are vital components of the information professional's toolbox. The value of these skills in action is immensely powerful and rewarding. It is fascinating to have an insight into the reasons behind the success, or otherwise, of someone's tactics and the vital messages they communicate by what they say and how they say it. It is enjoyable working out how to deploy the skills oneself and sharpen own awareness of the effect the techniques have on what one is trying to achieve. This lecture will introduce these influencing skills, identify when they're used and why they're important and share some ideas of useful approaches and phrases.

AIM

4. To acquaint the cadets with Influencing Skills and their importance.

PREVIEW

5. The class will be conducted in the following parts:-

(a)	Part I	-	Influencing Skills.
(b)	Part II	-	Types of Influencing Skills.
(c)	Part III	-	Useful Phrases and Techniques.

PART I : INFLUENCING SKILLS

6. **Why Influencing?** When we are persuading someone of something, whether bidding for resources, gaining support for a policy, creating a positive working relationship or winning respect from colleagues and customers, we are using our influencing skills. In the world of matrix management, flatter structures, project working and interprofessional multidisciplinary services, we often find ourselves needing to get something from those we don't manage, and who perhaps don't seem to think like we do. The more democratic and participative style of management we use today changes the dynamics of relationships at work. Sometimes the most influential person in an organisation isn't the one at the top. It's the one who knows how to influence the one at the top.

7. **What Is Influencing?** A dictionary definition suggests that it is when we change someone's views, attitudes, decisions, perceptions or beliefs to produce an effect on them in a positive way. It involves adapting your words and behaviour subtly through an awareness of the effect you are having on someone else. So it is about reading and understanding yourself and other people. Through these skills you can move things forward and gain agreement or change someone's mind and, importantly, you can achieve this without pushing, forcing or telling them what to do. It involves relationships with staff, colleagues, your manager and your customers, and is an indispensable tool for the information professional. In short, it is applied common sense blended with high level communication skills and a subtle gameplan.

PART II : TYPES OF INFLUENCING SKILLS

8. In the succeeding paragraphs you shall be introduced to four influencing skills, which are largely based on ideas from the excellent and accessible books and articles. To some extent, influencing skills are just applied interpersonal and communication skills, so none of these is likely to be new to you, but this may help you to see them in a new light.

(a) **Skill 1 - Probing And Listening.**

(i) Active listening and asking probing questions are classic communication skills, featuring in areas such as interviewing and appraisal and, of course, the reference interview. They are about involving a person in the discussion, encouraging them to think through the rationale you are presenting and thinking through what it means for them. And the more you listen, the more likely it is that the other person will listen to you.

(ii) If you ask someone a question, you're pretty likely to get an answer, so try and make much of your conversation: asking rather than telling. This creates a subtle shift in the balance of the discussion and involves the other person much more as an active participant. They are more likely to feel comfortable with a conversation in which they are playing a major part. It also gives you more control of the pace and direction, and of valuable thinking time, since we can all think faster than we can talk.

(iii) Ask open questions for exploring the other person's thinking (e.g. How do you feel about that suggestion?) and closed questions for checking facts and understanding (e.g. Have I explained that clearly enough?). Listen actively and ask reflective questions that echo back your understanding of what you've heard, to check your understanding (e.g. You're in two minds about this?). If they disagree with you, resist the temptation to argue back, and ask questions to understand better their point of view. If there is an objection, you'd better hear it if you're going to get past it. You will gain a good feel for how they are thinking, so that you can put your ideas in a way that they might find acceptable.

(b) **Skill 2 - Building Rapport.** This is about getting on the same wavelength as the other person, and gearing your pace and timing to theirs. If you articulate clearly the

direction in which you are taking the conversation, you will keep them on board and save them some of the trouble of working out what you mean. For example, imagine that you are discussing with a member of staff why their interaction with an academic colleague went badly wrong and resulted in a complaint. How might you build and maintain rapport so that the conversation achieves a positive outcome?

(i) **Sign Posting.** Is a technique you may use subconsciously, but it is very effective when used tactically in a number of ways:-

(aa) To state clearly the intention of what you are about to say, so that they are prepared for it, and to help them focus on your meaning (e.g. Let me put a suggestion to you or I'm going to play devil's advocate ...). This attracts their attention and makes them receptive to considering what they think about it.

(ab) To soften the introduction of difficult subjects, showing that you recognise that something is sensitive and you respect how they may feel about it (e.g. There's a tricky matter I'd like to talk to you about).

(ac) To provide a kind of commentary to the discussion, adding a description of how it is going (e.g. Let's just see if I understand your perspective on what happened).

(ii) **Pacing.** Involves assessing the rate of your progress by checking the other person's understanding. This may be by using the questioning techniques described earlier, or through summarising where you feel you've got to. This will check that they have understood, whilst also reinforcing common ground and areas of agreement by repeating them. It's no use trying to push someone along at your mental pace. You already understand what you're trying to get across but they don't, and you'll just leave them behind, all bewildered. If you're enthusiastic about something or you're under pressure to get an agreement, it's very easy to race ahead. In the example above, there is no point in rushing to get the staff member to admit that the conversation with the academic member of staff went wrong from the outset. Pull too hard and the thread of understanding between you will snap. Success lies in convincing them of your points by supporting them to think through the arguments for themselves. What did they intend to achieve? How might the conversation have gone better? What steps might they have taken to reach agreement with the academic? That isn't something you can just tell them. Remember to check how their understanding is progressing, and avoid breaking the rapport by making them feel either rushed or cornered.

(iii) Your choice of language is also very important. Negative or overly formal language will affect the tone of the discussion and disturb the rapport you are aiming for. It is always possible to say 'and' rather than 'but' to move the topic on from areas of difference and avoid such a negative full-stop. 'Parental' words such as 'should' and 'ought' annoy people, as no one likes being told what they should think or do.

(c) **Skill 3 - Selling.**

(i) Selling has become a somewhat uncomfortable word, but influencing uses very similar principles. Salespeople have a reputation for getting you to buy something you don't want, but really they are trying to persuade you of the link between their product and your needs, that is, to influence you to buy it. The tactics are to find out what is important to the other person and gear your discussion to the things that will attract them and serve their needs.

(ii) An example would be the perennial effort to persuade a course leader to include information skills in their programme. It is obvious to you why this would be a good idea, what benefits it will bring the students and the strategic objectives it will fulfil. Rehearsing the features of information literacy as a graduate skill and the need to include these skills in assessments may not be of much interest to the course leader, but by asking and listening you may find out that he's under pressure to introduce more e-learning into the course, and you happen to have some information skills materials ready to customise for this subject. His external examiner report may suggest that the students need more help avoiding plagiarism, and you may have a session prepared that includes this with information skills development. The virtues of producing an information literate graduate may not be enough to convince everyone, so in this case the focus has moved to what the course leader needed to 'buy' to solve his current problems. After all, no one wants to buy double-glazing because they want new windows (the features) – what they actually want is to keep the warmth in and the noise out (the benefits).

(d) **Skill 4 - Assertiveness.**

(i) Sometimes assertiveness is seen as almost synonymous with aggression but, in the positive sense in which we might use it in the workplace, it is controlled behaviour that is planned and well-thought-out to lead to the outcome you want. Assertiveness skills boost persuasiveness and enhance influence. Our personality style and characteristic thoughts and beliefs may sometimes lead us to react in negative or defensive ways when confronted with certain situations, and assertiveness is about overcoming these automatic responses and behaving according to the plan.

(ii) It means being straightforward and clear about what you want to say, always keeping to the point and being succinct. Leave out the padding and make sure everything is relevant to the position you're trying to put across. When things get difficult, an approach such as the 'broken record' technique of repeating a point several times, with a little variation, will allow you to keep focused and calm. It will also protect you against being put off course by use of emotional pressure or manipulation, as you can just keep coming back to your point in a neutral way. Equally, it is helpful to think about the other person's behaviour (what you actually see and hear) rather than any personality traits, attitudes or assumptions you think they may have (what you think it means). Assertiveness is based on characteristics we value in others, being straight forward and tolerant, so it is likely that people will appreciate these in us too, and listen with increased trust.

PART III : LAWS AND PRINCIPLES OF INFLUENCE

9. **The Six Laws of Influence.** Professor Robert Cialdini gives six laws or rules which govern how we influence and are influenced by others.

(a) **The Law of Scarcity.** **Items are more valuable to us when their availability is limited.** Scarcity determines the value of an item. For example if a customer is told that an item is in short supply which will soon run out they are more likely to buy it. Time also works here. A time limit is placed on the customer's opportunity to buy something. Customers are told by the seller that unless they buy immediately, the price will increase next week. Auctions such as ebay create a buyer frenzy often resulting in higher prices than the object's value. If something is expensive, we tend to assume that it must be of high quality because it is in demand: one jewellery shop doubled the price of its items and were surprised to find that sales increased! For example, if you let an interviewer know that you have other interviews coming up, they will be more interested in you as you are perceived as a sought after candidate.

(b) **The Law of Reciprocity.** **If you give something to people, they feel compelled to return the favour.** People feel obliged to return a favour when somebody does something for them first. They feel bad if they don't reciprocate. "You scratch my back and I'll scratch yours". After someone has turned down a large request, they are very likely to agree to a smaller request. This is why shop staff are trained to show the most expensive item first. A salesman who suggested a 3 year warranty costing Rs 100 found that most customers refused but were then happy to buy 1 year warranty costing Rs 30.

(c) **The Law of Authority.** **We are more likely to comply with someone who is (or resembles) an authority.** In other words, people prefer to take advice from "experts". There is a deep seated duty to authority within us learned from parents, school, religious authorities etc.

(d) **The Law of Liking.** **We are more inclined to follow the lead of someone who is similar to us rather than someone who is dissimilar.** We learn better from people who are similar to us. We are more likely to help people who dress like us, are the same age as us, or have similar backgrounds and interests. We even prefer people whose names are similar to ours. For this reason, sales trainers teach trainees to mirror and match the customer's body posture, mood and verbal style. Research has **found that people more easily remember faces of their own race, age group or gender** than those of others. It's also very important to **remember and use people's names**. Others are much more likely to like you and respond to you if you say "*Hello Sarah*" rather than just "*Hello*".

(e) **The Law of Social Proof.** **We view a behaviour as more likely to be correct, the more we see others performing it.** We assume that if a lot of people are doing the same thing, they must know something that we don't. Especially when we are uncertain, we are more likely to trust in the collective knowledge of the crowd. This explains herd or lemming behaviour. For example when there is panic in the stock market everyone follows everyone else and sells, however great investors such as Warren Buffett, know that this is the time when the best bargains are to be had, and instead, buy.

(f) **The Law of Commitment and Consistency.** **Consistency is seen as desirable as it is associated with strength, honesty, stability and logic.** Inconsistent people may be seen as two-faced, indecisive and "butterflies": never committing themselves for long enough to complete tasks. People will do more to stay consistent with their commitments and beliefs if they have already taken a small initial step. If you can get someone to do you a small favour, they are more likely to grant you a larger favour later on. **If someone does you a favour, let them know afterwards what happened:** they will appreciate your feedback and may be able to help you further in future. We evaluate a university more positively when we have got into it or a car we have bought when we own it. We look for the good points in the choice we have made or items we have bought as this justifies to ourselves our consistency of choice.

10. **Influencing Principles.**

(a) **Making a Start.**

(i) 'What issues do you think we should consider in deciding this?', 'Let's pick this suggestion apart', 'How do you think we can move forward on this?', 'What would be the effect if you ...?', 'Let's think through how we could make it work.'

(ii) Focus on common ground to begin with. Resist the temptation to go straight to any areas of difference.

(iii) Make it easy to say yes. Make it hard to say no.

(b) **Buy Yourself Thinking Time.**

- (i) 'You've given me a lot to take in here. Do you mind giving me some time to think it through?'
- (ii) 'Let me make sure I understand what you're saying.'
- (iii) 'Explain to me again how you would see the plan working.'

(c) **Dealing With Disagreement.**

- (i) Don't say 'but'; say 'and'. Present your views as an addition to, rather than a contradiction of, the other person's.
- (ii) Disagreeing with someone produces a 60% chance that they will disagree back.
- (iii) Ask for clarification, seek ideas, make suggestions. Don't state objections.
- (iv) Your worst enemy is your own quick reaction.

(d) **Difficult And Sensitive Situations.**

- (i) Name the emotion – 'I can see you're angry', 'It's not worth getting upset.'
- (ii) Make 'I' statements, rather than 'you' statements: 'I feel let down' rather than 'You let me down'; 'I feel uncomfortable when you speak to me like that'; 'It concerns me that you feel that way.'
- (iii) 'There's something I'd like to discuss with you. It's a bit sensitive, so may I just describe how it looks to me?'

CONCLUSION

11. You will find these skills and ideas useful in your day-to-day work. The next time you're in a meeting, make a mental note of the techniques you see other people using to get their points across and to deal with disagreement. And, most importantly, when you next need to influence a colleague or customer, or your manager, jot down some ideas about how you're going to approach it and some helpful phrases and make a plan.

LESSON PLAN : P 17
BODY LANGUAGE

Period	-	Two
Type	-	Lec
Code	-	P 17
Term	-	III (SD/SW)

Training Aids

1. Computer Slides, Pointer, Charts, Black Board and Chalk.

Time Plan

2.	(a)	Introduction	-	05 Min
	(b)	Body Language Parts	-	30 Min
	(c)	Body Language Signs and their Meanings	-	40 Min
	(d)	Conclusion	-	05 Min

INTRODUCTION

3. The technique of "reading" people is used frequently. For example, the idea of mirroring body language to put people at ease is commonly used during interview situations. Body language can show feelings to other people, which works in return for other people. People who show their body language to you, can reveal their feelings and meanings. Mirroring the body language of someone else indicates that they are understood.

AIM

4. To acquaint the cadets about Body Language.

PREVIEW

5. The lecture will be conducted in following parts :-
 - (a) Part I - Body Language Parts.
 - (b) Part II - Body Language Signs and their Meanings.

PART I : BODY LANGUAGE PARTS

6. **What is Body Language.** Body language is a form of mental and physical ability of human non-verbal communication, consisting of body posture, gestures, facial expressions, and eye movements. Humans send and interpret such signals almost entirely subconsciously. James Borg states that human communication consists of 93 percent body language and paralinguistic cues, while only 7% of communication consists of words themselves. Others assert that research has suggested that between 60 and 70 percent of all meaning is derived from nonverbal behavior. Body language may provide clues as to the attitude or state of mind of a

person. For example, it may indicate aggression, attentiveness, boredom, relaxed state, pleasure, amusement, and intoxication.

7. **Body Parts Involved in Body Language.** The following body parts are generally observed while studying Body Language:-

- (a) Facial and Mouth Expressions.
- (b) Eye Contact and Eye Expressions.
- (c) Tone of Speech.
- (d) Posture of the Body.
- (e) Movements of Hands / Fingers.
- (f) Movements of Legs.

8. **Personal Space Distances.** Proximity range varies with culture. Proximity of a person may reveal the type of social setting taking place:-

- (a) **Intimate Distance.** This ranges from touching to about 18 inches (46 cm) apart, and is reserved for lovers, children, as well as close family members and friends, and also pet animals.
- (b) **Personal Distance.** This begins about an arm's length away; starting around 18 inches (46 cm) from the person and ending about 4 feet (122 cm) away. This space is used in conversations with friends, to chat with associates, and in group discussions.
- (c) **Social Distance.** This ranges from 4 to 8 feet (1.2 m - 2.4 m) away from the person and is reserved for strangers, newly formed groups, and new acquaintances.
- (d) **Public Distance.** This includes anything more than 8 feet (2.4 m) away, and is used for speeches, lectures, and theater. Public distance is essentially that range reserved for larger audiences.

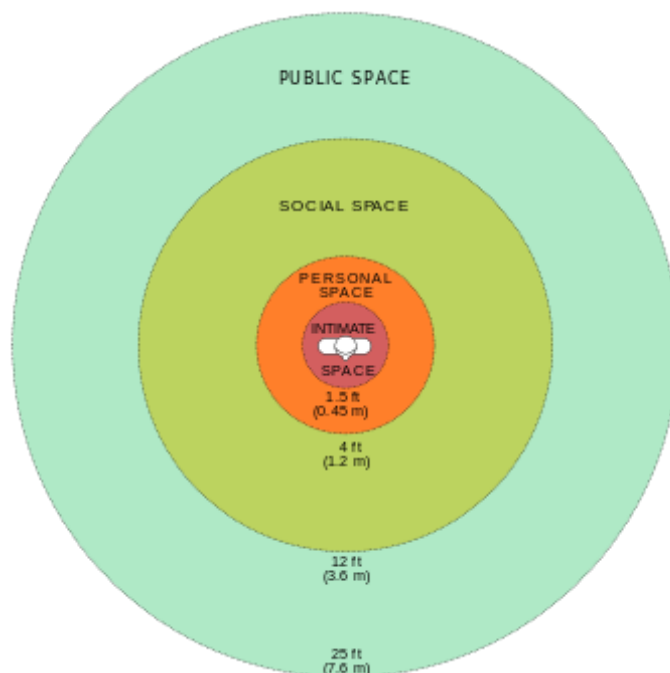

PART II : IMPORTANT BODY LANGUAGE SIGNS AND THEIR MEANING9. **Eyes.**

Signal	Possible Meaning(S)
Looking Right (Generally)	Creating, Fabricating, Guessing, Lying, Storytelling
Looking Left (Generally)	Recalling, Remembering, Retrieving 'Facts'
Direct Eye Contact	Honesty - or Faked Honesty
Direct Eye Contact (When Listening)	Attentiveness, Interest, Attraction
Looking Right And Up	Visual Imagining, Fabrication, Lying
Looking Right Sideways	Imagining Sounds
Looking Right And Down	Accessing Feelings
Looking Left And Up	Recalling Images Truthfulness
Looking Left Sideways	Recalling Or Remembering Sounds
Looking Left Down	Self-Talking, Rationalizing
Widening Eyes	Interest, Appeal, Invitation
Blinking Frequently	Excitement, Pressure
Eyebrow Raising	Greeting, Recognition, Acknowledgement

9. **Mouth.**

Signal	Possible Meaning(S)
Pasted Smile	Faked Smile
Tight-Lipped Smile	Secrecy or Withheld Feelings
Twisted Smile	Mixed Feelings or Sarcasm
Dropped-Jaw Smile	Faked Smile
Smile - Head Tilted, Looking Up	Playfulness, Teasing, Coy
Bottom Lip Jutting Out	Upset
Laughter	Relaxation
Forced Laughter	Nervousness, Cooperation
Biting Lip, Teeth Grinding, Chewing Gum	Tension, Suppression
Smoking	Self-Comforting
Thumb-Sucking, Chewing Pen Or Pencil	Self-Comforting
Tongue Poke	Disapproval
Nail Biting	Frustration

10. **Head.**

Signal	Possible Meaning(S)
Head Nodding	Agreement
Slow Head Nodding	Attentive Listening
Fast Head Nodding	Hurry Up, Impatience
Head Held Up	Neutrality, Alertness
Head Held High	Superiority, Fearlessness, Arrogance
Head Tilted to One Side	Non-Threatening, Submissive, Thoughtfulness
Head Forward, Upright	Interest, Positive Reaction
Head Tilted Downward	Criticism, Admonishment
Head Shaking	Disagreement
Pronounced Head Shaking	Strong Disagreement
Head Down (In Response to a Speaker or Proposition)	Negative, Disinterested
Head Down (While Performing An Activity)	Defeat, Tiredness
Chin Up	Pride, Defiance, Confidence
Active Listening	Attention, Interest, Attraction

11. **Arms.**

Signal	Possible Meaning(S)
Crossed Arms (Folded Arms)	Defensiveness, Reluctance
Crossed Arms With Clenched Fists	Hostile Defensiveness
Gripping Own Upper Arms	Insecurity
One Arm Across Body Clasp Other Arm by Side (Female)	Nervousness
Arms Held Behind Body with Hands Clasped	Confidence, Authority
Handbag Held in Front of Body(Female)	Nervousness
Adjusting Cuff, Watchstrap, Tie, etc., Using an Arm Across the Body	Nervousness
Arms/Hands Covering Genital Region (Male)	Nervousness
Holding a Drink in Front of Body with Both Hands	Nervousness

12. **Hands.**

Signal	Possible Meaning(S)
Palm(S) Up or Open	Submissive, Truthful, Honesty, Appealing
Palm(S) Up, Fingers Pointing Up	Defensive, Instruction to Stop
Palm(S) Down	Authority, Strength, Dominance
Palm Up and Moving Up and Down as if Weighing	Striving for or Seeking an Answer
Hand(S) on Heart (Left Side Of Chest)	Seeking to be Believed
Finger Pointing (At A Person)	Aggression, Threat, Emphasis
Finger Point and Wink	Acknowledgement or Confirmation
Finger Pointing (In The Air)	Emphasis
Finger Wagging (Side To Side)	Warning, Refusal
Finger Wagging (Up And Down)	Admonishment, Emphasis
Hand Chop	Emphasis - Especially the Last Word on a Matter
Clenched Fist(S)	Resistance, Aggression, Determination
Finger Tips and Thumbs Touching Each Other on Opposite Hands ('Steepling')	Thoughtfulness, Looking for or Explaining Connections or Engagement
Steepled Fingers Pointing Forward	Thoughtfulness and Barrier
Palms Down Moving Up and Down, Fingers Spread	Seeking or Asking for Calm, Loss of Control of a Group or Situation
Cracking Knuckles	Comforting Habit, Attention-Seeking
Interwoven Clenched Fingers	Frustration, Negativity, Anxiousness
Index Finger and Thumb Touching at Tips	Satisfaction, 'OK'
Thumb(S) Up	Positive Approval, Agreement, All Well
Thumbs Down	Disapproval, Failure
Thumb(S) Clenched Inside Fist(S)	Self-Comforting, Frustration, Insecurity
Hand Held Horizontally And Rocked From Side to Side	Undecided, In The Balance
Rubbing Hands Together	Anticipation, Relish
Hand(S) Clamped Over Mouth	Suppression, Shock
Touching Nose, While Speaking	Lying Or Exaggeration
Scratching Nose, While Speaking	Lying Or Exaggeration
Pinching Or Rubbing Nose, While Listening	Thoughtfulness, Suppressing Comment
Picking Nose	Day-Dreaming, Inattentive, Socially Disconnected, Stress

Pinching Bridge of Nose	Negative Evaluation
Hands Clamped on Ears	Rejection of or Resistance to Something
Ear Tugging	Indecision, Self-Comforting
Hands Clasping Head	Calamity
Hand Stroking Chin	Thoughtfulness
Hand Supporting Chin or Side of Face	Evaluation, Tiredness Or Boredom
Chin Resting on Thumb, Index Finger Pointing Up Against Face	Evaluation
Neck Scratching	Doubt, Disbelief
Hand Clasping Wrist	Frustration
Running Hands Through Hair	Flirting or Vexation, Exasperation
Hand(S) On Hip(S)	Confidence, Readiness, Availability
Hands in Pockets	Disinterest, Boredom
Removing Spectacles	Alerting Wish to Speak
Playing an Imaginary Violin	Mock Sympathy or Sadness
Thumb and Fingers Formed into a Tube and Rocked Side to Side or Up and Down	Offensive - Mockery, Dissatisfaction, Expression Of Inferior Quality
Two-Fingered V-Sign, Palm Inward	Offensive - Derision, Contempt
Two-Fingered V-Sign, Palm Outward	Victory, Peace

13. **Handshake.**

Signal	Possible Meaning(S)
Handshake - Palm Down	Dominance
Handshake - Palm Up	Submission, Accommodating
Handshake - Both Hands	Seeking To Convey Trustworthiness And Honesty, Seeking To Control
Handshake - Equal And Vertical	Non-Threatening, Relaxed
Pumping Handshake	Enthusiasm
Weak Handshake	Various
Firm Handshake	Outward Confidence
Handshake With Arm Clasp	Seeking Control, Paternalism

14. **Legs/Feet.**

Signal	Possible Meaning(S)
Leg Direction, Sitting - General	Interest, Attentiveness (According to Direction)

Uncrossed Legs, Sitting - General	Openness
Parallel Legs Together, Sitting (Mainly Female)	Properness
Crossed Legs, Sitting - General	Caution, Disinterest
Crossing Legs, Sitting - Specific Change	Interest or Disinterest in Direction of Upper Crossed Knee
American or Figure-4 Leg Cross	Independent, Stubborn
American or Figure-4 Leg Cross with Hand Clamp	Resistant, Stubborn
Open Legs, Sitting	Arrogance, Combative, Sexual Posturing
Ankle Lock, Sitting	Defensiveness
Splayed Legs, Standing	Aggression, Ready for Action
Standing 'At Attention'	Respectful
Legs Intertwined, Sitting (Female)	Insecurity or Sexual Posing
Legs Crossed, Standing (Scissor Stance)	Insecurity or Submission or Engagement
Knee Buckle, Standing	Under Pressure
Feet or Foot Direction or Pointing	Foot Direction Indicates Direction of Interest
Foot Forward, Standing	Directed Towards Dominant Group Member
Shoe-Play (Female)	Relaxation, Flirting, Sexual

CONCLUSION

15. Body language signals may have a goal other than communication. People would keep both these two in mind. Verbal communication also requires body language to show that the person you are talking with, that you are listening. These signals can consist of; eye contact and nodding your head to show you understand. More examples would include yawning (sleepiness), showing lack of interest (sexual interest/survival interest), attempts to change the topic. The study of Body Language is important not only to understand others but also for facing interviews.

LESSON PLAN : P 18
SOCIABILITY : SOCIAL SKILLS
ETTIQUETTES AND MANNERISM

Period	-	Two
Type	-	Lec
Code	-	P 18
Term	-	II / III (SD/SW)

Training Aids

1. Computer Slides, Pointer, Charts, Black Board and Chalk.

Time Plan

2.	(a)	Introduction	-	10 Min
	(b)	Etiquette &Types of Etiquette	-	20 Min
	(c)	Mannerisms	-	20 Min
	(d)	How to improve your Social Skills	-	20 Min
	(e)	Conclusion	-	10 Min

INTRODUCTION

3. Etiquette, the manners and forms prescribed by custom, usage, or authority and accepted when people deal with each other, as correct or proper behavior. Etiquette is necessary to have an effective and well groomed personality. It is considered as an everlasting impression on the people you meet. This does not only refer about etiquette but also public mannerism. Mannerism is any exaggerated style, distinctive traits, or behavioral habit of one individual. Etiquette and public mannerism can be good or bad impression depending on how we behave. To have an everlasting good impression on the people we meet, we must possess a qualities to build a personality that is charming, decent, lovable and welcome anywhere & everywhere we go. The question of, why the people having command over English is given preference, the reason lies with the fact that there is only frequent and fluent communication that lets a person explore in a company and enhances his/her own skill bagging much early promotion. Strong etiquettes and good manners always matters much, Etiquettes and mannerism describes an internal personality. Not only an effective communication skill demonstrates a personality but it gives interviewer an overlook as is the applicant really serious about the company or just enhancing his interviewing venues. The real significance of etiquettes and manners lies within the fact that a person's behaviour and his etiquettes matters a lot as a single mal-behaving attitude might destroy the impression of a country.

AIM

4. To acquaint the class with the importance of Etiquettes and Mannerisms in social life and how to pay compliments as an NCC Cadets.

PREVIEW

5. The class will be conducted in the following parts:-

- (a) Part I - Types of Etiquettes.
- (c) Part II - Mannerisms.
- (d) Part III - How to improve your Social Skills.

PART I : TYPES OF ETIQUETTE

6. Etiquette is a code of behaviour that delineates expectations for social behavior according to contemporary conventional norms within a society, social class, or group. Rules of etiquette encompass most aspects of social interaction in any society. The various types of etiquettes is discuss below:

7. **Types of Etiquettes.**

- (a) **Social Etiquette.** Social etiquette is important for an individual as it teaches him how to behave in the society.
- (b) **Bathroom Etiquette.** Bathroom etiquette refers to the set of rules which an individual needs to follow while using public restrooms or office toilets. Make sure you leave the restroom clean and tidy for the other person.
- (c) **Corporate Etiquette.** Corporate Etiquette refers to how an individual should behave while he is at work. Each one needs to maintain the decorum of the organization. Don't loiter around unnecessary or peep into other's cubicles.
- (d) **Wedding Etiquette.** Wedding is a special event in every one's life. Individuals should ensure they behave sensibly at weddings. Never be late to weddings or drink uncontrollably.
- (e) **Meeting Etiquette.** Meeting Etiquette refers to styles one need to adopt when he is attending any meeting, seminar, presentation and so on. Listen to what the other person has to say. Never enter meeting room without a notepad and pen. It is important to jot down important points for future reference.
- (f) **Telephone Etiquette.** It is essential to learn how one should interact with the other person over the phone. Telephone etiquette refers to the way an individual should speak on the phone. Never put the other person on long holds. Make sure you greet the other person. Take care of your pitch and tone.
- (g) **Eating Etiquette.** Individuals must follow certain decorum while eating in public. Don't make noise while eating. One should not leave the table unless and until everyone has finished eating.
- (h) **Business Etiquette.** Business Etiquette includes ways to conduct a certain business. Don't ever cheat customers. It is simply unethical.

8. **Need for Etiquette.**

- (a) Etiquette makes you a cultured individual who leaves his mark wherever he goes.

- (b) Etiquette teaches you the way to talk, walk and most importantly behave in the society.
- (c) Etiquette is essential for an everlasting first impression. The way you interact with your superiors, parents, fellow workers, friends speak a lot about your personality and up- bringing.
- (d) Etiquette enables the individuals to earn respect and appreciation in the society. No one would feel like talking to a person who does not know how to speak or behave in the society. Etiquette inculcates a feeling of trust and loyalty in the individuals. One becomes more responsible and mature. Etiquette helps individuals to value relationships.

PART II : MANNERISMS

9. Some of the manners we've learned from our parents and teachers who try and implant us the importance of being well-mannered. At some point, our manners are categorized as good or bad depending on the society we live in and on the environment we grew in. Here's a list of some very poor mannerism we observed a lot (actually there's a lot more of them):

- (a) Eating with your mouth open.
- (b) Making loud noise and slurping sound while eating.
- (c) Picking your nose in the public.
- (d) Biting nails.
- (e) Spitting in the public.
- (f) Coughing and yawning and without covering your mouth.
- (g) Sneezing without covering your nose.
- (h) Crossing the road wherever you feel like (ignoring No Jaywalking signs).
- (i) Acting rude and vulgar jokes in front of ladies colleague.
- (j) Not saying please and thank you.
- (k) Not saying "excuse me" when trying to get pass someone.
- (l) Ridiculing someone for his physical limitations and shortcomings.
- (m) Smoking at prohibited places.
- (n) Barging on someone's room without permission.
- (o) Not saying "sorry" when you bump into somebody.

10. The main reason for making us forget social courtesies is **eccentricity**. And one way to gain respect in the society is to learn to respect also the society. Remember the Golden Rule "Do unto others as you would have others do unto you. All good manners start from home. Though there are times that we learned on what we saw. Some male youth pee on the public post and walls because when they're young they saw grown-ups doing that thing and they think it is ok which is definitely NOT.

11. Having good manners is not just about blending with the best; rather it is more about considering the feelings of others and taking responsibility. Take for example when you eat in the restaurant or in public places, try not to chew with one's mouth open. The unpleasant sound and scene is repelling for others. In public speaking, we must not interrupt when he/she is talking. It is considered highly ill-mannered if you do not complete his sentence. These are just some of the things we should avoid doing.

PART III : HOW TO IMPROVE YOUR SOCIAL SKILLS

13. They say, a human being is a social animal, but the question is, does everyone possess social skills? Most of the people do not know the art of speaking. While some are just inept and incompetent, there are others who lack confidence and yet others who do not have mannerism and etiquettes. Having sound social skills is extremely important in the present times, given to the fact that interaction and conversation forms the basis for everything we do. If you also face difficulty in interacting, remember, it is not the end of the world. You can improve your social skills by just putting in a little effort. However, you cannot be perfect overnight. It would take some time, but believe me; it would be worth the wait. Just focus on qualities listed below and who knows, from being ineffective, you might just turn out to be the 'apple' of the social meets. In the following lines, we have provided tips on how to improve social skills, just for you.

14. **Improving Social Skills.**

(a) **Be Yourself.** Only when you are your own self do you feel comfortable. And it is when you are in utmost comfort that you indulge in free conversation and interaction. Do not change your inner self for anything in the world. Remember, humans have this innate quality of discovering whether a person is real or fake. In case you pretend to be someone you are not, trust me, you would be lonelier than ever before.

(b) **Be Responsible.** One of the vital components of social interaction is to know that art of carrying yourself. It is very important for you to know what to do and how to behave in a social gathering. A person behaving in an undesirable and unacceptable manner is usually avoided by people. So, be responsible for your actions and act according to the situation.

(c) **Be Open & Approachable.** Imagine talking to a person who is an absolute introvert or extrovert! Extremes of personality often turn off people. Ideally, you should have a fusion of both the characters. While being too shy and withdrawn is enough to repel people immediately, being too loud and outgoing would not do much good either. Just strike a delicate balance between both the personalities and you would be the 'star' of the social gathering.

(d) **Be Attentive.** The art of listening is a stepping stone for conversation and interaction. Alas! Not many have it in them. If you would have attended a social gathering, you will know that everyone wants to talk, but no one is ready to listen. So, the trick is to be an attentive listener and people would definitely talk to you. Also, do not interrupt or chip in a piece of advice or suggestion just when the other person is in the middle of a subject.

(e) **Be Polite.** Being humble and down-to-earth is an excellent way to break the ice. It sheds off all the apprehensions and nervousness and gives a good impression. It would speak miles about your manners, personality and confidence. Apart from being polite, it is also advisable to be diplomatic. While being honest and forthright definitely pays, sugar-coating the truth is very necessary at times.

(f) **Be Aware.** It is very important to be aware and observant of people's behavior. For instance, watch if the person you are talking to is comfortable with the specific topic. If he looks uncomfortable or is simply disinterested, just move on to the next topic. In case

he/she is not interested in talking to you completely, the best bet would be to move out of the scene.

(g) **Be Cautious.** It is advisable to keep your senses active. Do not shut your eyes, close your ears and numb your senses at the time of interacting. Keep a keen eye on who are your friends and who are your enemies. Do not confront everything to someone you have just met.

CONCLUSION

15. The point of etiquette is not, of course, the rules themselves but the comfort of the people concerned. Exhibiting bad manners and “I don’t care a damn” attitude are the ones who are the social outcast. Manners that put a strain on others are not good manners, no matter whose rules they follow. Remember, having good manners and etiquette can gravitate everybody towards you.

LESSON PLAN : P 19
VALUES / CODE OF ETHICS

Period	-	One
Type	-	Lec
Code	-	P 19
Term	-	II (SD/SW)

Training Aids

1. Computer Slides, Pointer, Charts, Black Board and Chalk.

Time Plan

2.	(a)	Introduction	-	05 Min
	(b)	Value	-	15 Min
	(c)	Code of Ethics	-	15 Min
	(d)	Conclusion	-	05 Min

INTRODUCTION

3. It is a well accepted fact that the future of any nation is largely related to the quality of its human beings. In this context, development of the youth into confident leaders with requisite character qualities and personal attributes, so that they can take their place as responsible citizens of the country, assumes great importance. In order to achieve this objective the youth needs to be exposed, beside the academics, to such activities which help them in developing their personality and character and in-turn making them a good leader. Leadership is an important feature of every sphere of human activity, whether at play, work or at war. In fact, wherever there are two or more people functioning together, there is a need for a leader. To develop into a good leader, a person needs certain values in him or one can say he must possess distinctive ethics in his life.

AIM

4. To acquaint the cadets about the importance of Values and Code of Ethics.

PREVIEW

5. The class will be conducted in the following parts:-
 - (a) Part I - Meaning of Values / Ethics.
 - (b) Part II - A Few Important Values.

PART I : VALUES

6. **Meaning of Value / Ethics** 'Value' means a standard of behaviour and 'Ethics' in turn means a set of moral principles that govern a persons behaviour. In ancient India young boys and girls learnt the fundamentals of correct behaviour and moral principles under

the tutelage and guidance of saints and gurus in their gurukuls and at a later stage specialized in various fields of knowledge. A person of values excels others in all fields. The values and ethics which drive a person may be inherited from the society they live in, i.e. from the people around them and to a large extent the family they hail from.

7. Human being is a complex creature, a mixture of good and evil. The evil tendencies in him are of negative nature which ultimately lead to destruction. On the other hand goodness is manifested in brotherhood, unity, co-operation. This goodness can only overcome negative tendencies, if a person either has certain values inherent in him, or he inculcates them.

8. A leader may be intelligent, knowledgeable and hard-working, but unless he is driven by a set of values which are morally acceptable, he cannot be a good leader. The importance of good behaviour by a leader on all occasions cannot be too strongly emphasized. Behaviour must be beyond reproach. Generally a group in particular and its work and achievements as a whole are judged by the values and the behaviour and good manners of the leader.

PART II : A FEW IMPORTANT VALUES

9. A person's behaviour is reflected in his conduct. How a person behaves in a particular situation will be an indicator of his potential for leadership. As the old saying goes 'Practice what you preach', as a leader is the person who guides the group, the saying is more applicable to him. Only those values can be preached which a leader himself possesses. Certain values which impress everybody are - Honesty, Truthfulness, Sense of duty, Loyalty, Consideration for the people, giving others their due and to stand by one's own principles. A person who practices good human values and follows a principled code of ethics will essentially stand out as a good leader. A few important values in day to day life are as follows:-

- | | | | |
|-----|----------------------------|---|--|
| (a) | <u>Honesty</u> | - | not to steal, cheat or lie. |
| (b) | <u>Integrity</u> | - | uprightness. |
| (c) | <u>Purity</u> | - | no duplicity, insincerity in thought, word or deed. |
| (d) | <u>Discipline</u> | - | behaviour according to essential rules and norms which is self-imposed. |
| (e) | <u>Selflessness</u> | - | unselfishness, rise above selfish or self-centered individualism, self-sacrifice. |
| (f) | <u>Loyalty</u> | - | true, faithful to duty, love or obligation to person/ institution, faithful in allegiance to the nation or mother country. |
| (g) | <u>Fairness</u> | - | being impartial, give right decision. |
| (h) | <u>Equality</u> | - | treat everyone equally. |
| (j) | <u>Trust</u> | - | firm belief in the reliability, ability, strength of someone or something. |
| (k) | <u>Support</u> | - | give help, encouragement, or approval. |
| (l) | <u>Respect</u> | - | a feeling of admiration for someone because of their qualities. |

CONCLUSION

10. The negative attributes to be guarded against would largely be such as ignorance, ego, i.e. attachment to self or the prominence of 'I' temptations, envy, hate or jealousy, lack of confidence. These have deleterious effects and affects the individual in his thoughts and actions. An individual has to evolve his own mechanism to counter these to become a successful and ideal leader.